

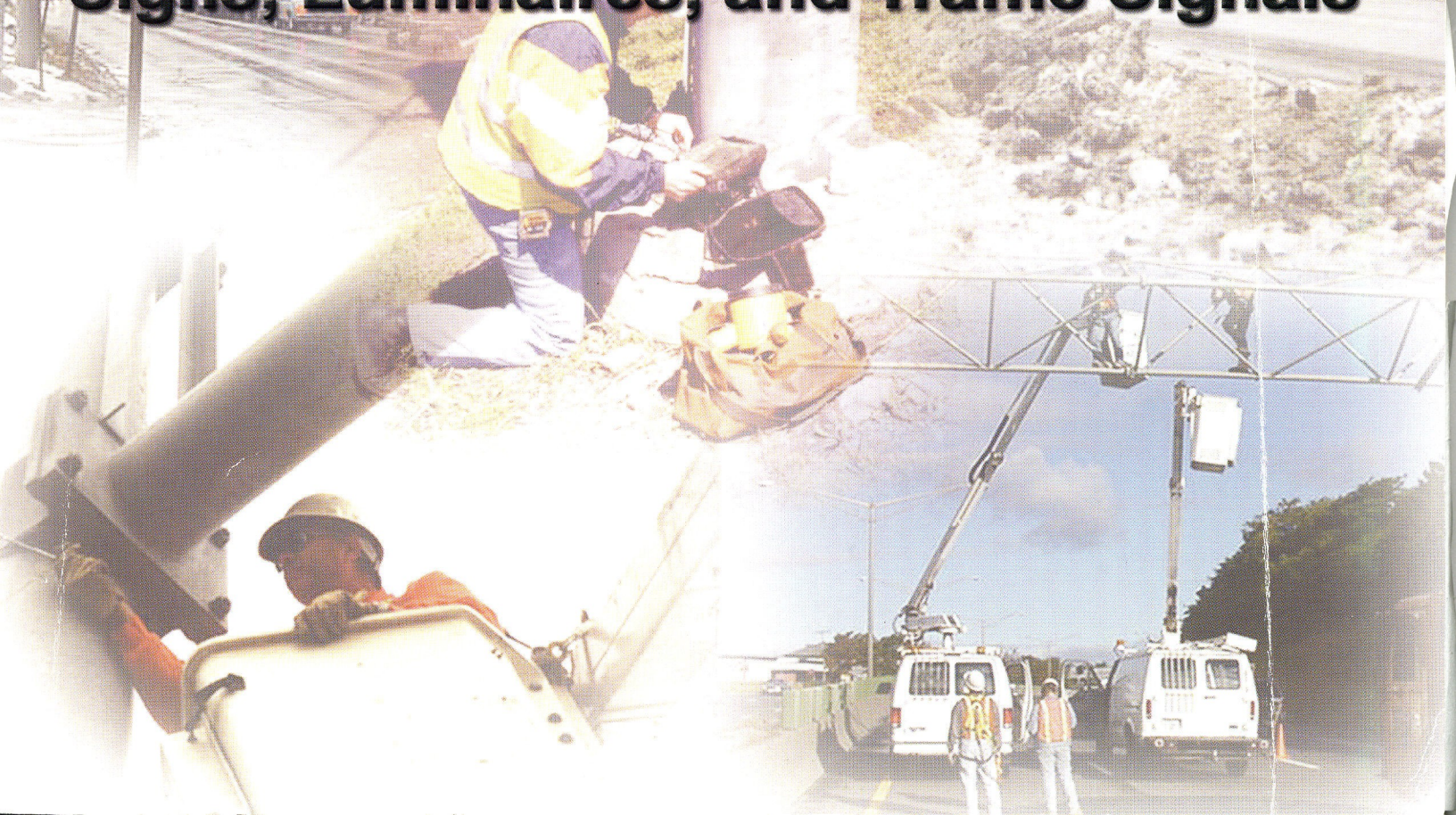

# **Guidelines for the Installation, Inspection, Maintenance and Repair of Structural Supports for Highway Signs, Luminaires, and Traffic Signals**



# TABLE OF CONTENTS

	<u>Page</u>
LIST OF FIGURES .....	vi
LIST OF TABLES.....	viii
1.0 INTRODUCTION.....	1
2.0 SCOPE.....	1
3.0 MATERIALS.....	2
3.1 Material Types.....	2
3.2 Corrosion Protection.....	3
3.3 Notch Toughness .....	6
4.0 LOAD EFFECTS .....	7
4.1 General.....	7
4.2 Natural Wind Gusts .....	8
4.3 Truck-Induced Wind Gusts.....	9
4.4 Vortex Shedding.....	10
4.5 Galloping .....	11
4.6 Fatigue .....	13
5.0 ERECTION OF SIGN, SIGNAL, AND LIGHT SUPPORT STRUCTURES.....	14
5.1 General.....	14
5.2 Shop Inspection.....	15
5.3 Preparation for Erection .....	15
5.4 Erection Procedure.....	17
6.0 BOLTED CONNECTIONS .....	19
6.1 High-Strength Bolts .....	19
6.2 Stainless Steel Fasteners.....	20
6.3 Aluminum Fasteners .....	21
6.4 Installation of Bolts and Fasteners .....	21
6.5 Anchor Rods.....	24
6.5.1 General .....	24
6.5.2 Materials .....	24

## TABLE OF CONTENTS (continued)

	<u>Page</u>
6.6	Base Plate and Holes..... 28
6.7	Anchor Rod Joints ..... 29
6.8	Installation of Anchor Rods ..... 33
6.9	Procedures for Anchor Rod Tightening and Follow-Up Retightening..... 35
7.0	MANAGEMENT OF INVENTORY..... 38
7.1	Collection of Inventory Information..... 38
7.2	Database Development..... 38
7.3	Example Inventory Checklist ..... 39
7.4	Inventory Numbering ..... 40
8.0	INSPECTION VARIABLES ..... 40
8.1	Types of Inspections ..... 40
8.1.1	Initial Inspection ..... 40
8.1.2	Routine ..... 40
8.1.3	In-Depth ..... 40
8.1.4	Interim Inspection ..... 40
8.1.5	Damage Inspection..... 41
9.0	INSPECTION FREQUENCY..... 41
10.0	INSPECTION PRIORITIES AND PLANNING ..... 41
11.0	REQUIRED RESOURCES ..... 42
11.1	Suggested Personnel Requirements..... 42
11.2	Tools and Equipment ..... 43
11.3	Traffic Control..... 44
11.4	Safety ..... 46
12.0	THE INSPECTION PROCEDURE ..... 47
12.1	Pre-Inspection Review of Available Materials (Desk Review)..... 47
12.2	Inspection Nomenclature..... 47
12.2.1	Sign Bridge ..... 47
12.2.2	Cantilever Sign Structure..... 47

## TABLE OF CONTENTS (continued)

	<u>Page</u>
12.2.3 Mast Arm Structure.....	48
12.2.4 Signal Supports .....	48
12.2.5 Light Poles .....	48
12.2.6 Detailed Nomenclature .....	48
12.2.7 Orientation of Members .....	52
12.3 Sequence of Inspection .....	53
12.3.1 Sign Structures .....	54
12.3.2 Mast Arm Structures and Signal Supports.....	56
12.3.3 Light Poles and High Mast Lights .....	57
12.4 Non-Destructive Testing.....	60
12.5 Quality Control Plan .....	62
13.0 ELEMENT INSPECTION .....	63
13.1 Element Definitions .....	63
14.0 ELEMENT CONDITION RATING .....	65
14.1 PONTIS Element Definitions and Ratings.....	66
15.0 INSPECTION REPORT .....	75
16.0 MAINTENANCE AND REPAIR .....	76
16.1 Prioritization of Work .....	76
16.2 Routine Maintenance .....	77
16.2.1 Foundations .....	77
16.2.2 Connections.....	78
16.2.3 Coatings.....	78
16.3 Repairs .....	79
16.3.1 Foundations .....	79
16.3.1.1 Concrete.....	79
16.3.1.2 Anchor Rods .....	80

## TABLE OF CONTENTS (continued)

	<u>Page</u>
16.3.2 End Frames and Posts .....	80
16.3.2.1 Gouges.....	81
16.3.2.2 Impact Damage.....	81
16.3.2.3 Corrosion.....	81
16.3.3 Trusses and Mast Arms.....	81
16.3.3.1 Connections .....	81
16.3.3.2 Cracks .....	81
16.3.4 Longitudinal Splits and Cracks .....	82
16.3.5 Composites for Repairs .....	83
16.3.5.1 Material Properties.....	83
16.3.5.2 Repair Examples.....	83
16.3.6 Vibration Dampeners .....	84
16.3.6.1 Types of Dampeners.....	84
REFERENCES .....	86

### APPENDIX A - EXAMPLE ELEMENT RATING

Foundation - S.01.....	A-1
Anchor Bolts - S.02 .....	A-2
Base Plate (s) - S.03 .....	A-3
Towers - S.04.....	A-4
Tower to Truss/Chord/Arm Connection(s) - S.05.....	A-5
Truss Chords/Arms - S.06.....	A-6
Truss Struts - S.07 .....	A-7
Cracks - S.08 .....	A-8
Chord Splice Connection(s) - S.09.....	A-9
Sign Frame and L-Brackets - S.10.....	A-10
Sign Panels - S.11 .....	A-11
Catwalk - S.12.....	A-12
Power and Luminaries - S.13.....	A-13
Sign Attachment(s) - S.15.....	A-14
Vertical Clearance, Camber and Alignment - S.16 .....	A-15
Protection - S.17 .....	A-16
Other - S.18.....	A-17

## TABLE OF CONTENTS (continued)

	<u>Page</u>
APPENDIX B - EXAMPLE INSPECTION REPORT FORMS .....	B-1
APPENDIX C - SAMPLE INSPECTION REPORT .....	C-1
APPENDIX D - ULTRASONIC ANCHOR INSPECTION PROCEDURE .....	D-1

## LIST OF FIGURES

<u>Number</u>		<u>Page</u>
Figure 1	Cantilever Sign Structure Failure.....	1
Figure 2	Failure of Weathering Steel Pole. Note the Corrosion Product .....	5
Figure 3	Truck Passing Under VMS .....	9
Figure 4A	Wind Effects .....	10
Figure 4B	Wind Effects .....	12
Figure 5	Foundation Ready for Structure Installation .....	17
Figure 6	End Frame Being Set Onto Its Foundation.....	18
Figure 7	Assembled Truss Being Lifted Into Place.....	19
Figure 8	Star Pattern Tightening Sequence .....	22
Figure 9	Bent Anchor Rod .....	26
Figure 10	Headed Anchor Rod .....	26
Figure 11	Threaded-Shear-and-Uplift Joint .....	30
Figure 12	Double-Nut-Moment Joint .....	31
Figure 13	Four Anchor Rod Group in a Template. Note Top is Galvanized.....	34
Figure 14	Template Secured to the Forms to Ensure Proper Alignment. Note Anchor Rod Threads Taped to Prevent Contamination by Concrete .....	34
Figure 15.	A Hydraulic Torque Wrench Tightening Anchor Rod Nuts to Achieve Needed Rotation.....	36
Figure 16	Inspector Measures Sign Panel During Inventory/Inspection Operation.....	38
Figure 17	Inspector Climbing Structure .....	44
Figure 18	Bucket Truck-Most Common Way to Access Sign Structure .....	44
Figure 19	Inspector Uses Double Lanyard System .....	47
Figure 20	Nomenclature Associated with Sign Bridge.....	49

## LIST OF FIGURES (continued)

<b><u>Number</u></b>		<b><u>Page</u></b>
Figure 21	Nomenclature for Ancillary Structure Tower Supports .....	50
Figure 22	Example-Truss to End Frame Connection Nomenclature .....	51
Figure 23	Sign Panel Support Components .....	52
Figure 24	Orientation of Overhead Sign Structures-New York State Department of Transportation .....	53
Figure 25	Hands on Inspection of Overhead Signs .....	54
Figure 26	Inspection of a Mast Arm Structure .....	56
Figure 27	Post to Arm Connection Showing Poor Fit-Up Due to Use of Incorrect Components .....	57
Figure 28	Loose Leveling Nuts on a High Mast Structure .....	58
Figure 29	High Mast Pole Slip Joint .....	59
Figure 30	Misaligned Luminaire Ring .....	59
Figure 31	Remotely Operated Inspection Device .....	60
Figure 32	Thickness Measurement at Critical Location of Structure Post .....	61
Figure 33	Ultrasonic Testing of Anchor Rods .....	62
Figure 34	Magnetic Particle Inspection of Weld at Post to Base Plate Connection .....	62
Figure 35	Base Plate with Added Anchor Rods .....	80
Figure 36	Repair Detail for Overhead Sign Truss Chord Crack .....	82
Figure 37	Repair of Truss Members Using FRP .....	83
Figure 38	Stockbridge Damper .....	84
Figure 39	Texas Flat Panel Damper .....	84
Figure 40	Wyoming Strand Damper .....	85



## LIST OF TABLES

<b><u>Number</u></b>		<b><u>Page</u></b>
Table 1	Material Specifications .....	2
Table 2	Susceptibility of Types of Support Structures to Various Wind-Loading Phenomena .....	7
Table 3	Stainless Steel Bolts.....	23
Table 4	Installation Torque for Mild Steel Fasteners.....	23
Table 5	Tensile Properties for Anchor Rods.....	24
Table 6	Acceptable ASTM A563 Nut, Grade, Finish and Style and ASTM F436 Washer Type and Finish for Threaded Anchor Rods .....	27
Table 7	Nominal Anchor Rod Hole Dimensions .....	29
Table 8	Nut Rotation for Turn-Of-Nut Pretensioning .....	33
Table 9	Element Definitions .....	63
Table 10	Element Condition Rating.....	65
Table 11	Repair Priority Rating .....	76

# **Guidelines for the Installation, Inspection, Maintenance and Repair of Structural Supports for Highway Signs, Luminaries, and Traffic Signals**

## **1.0 INTRODUCTION**

This document provides guidance for the installation, inspection, maintenance, and repair of structural supports for highway signs, luminaries and traffic signals. The primary purpose is to provide owners with information that can assist them in managing their inventory, identifying potential problem areas, and ensuring safe and satisfactory performance of these types of ancillary highway structures. The primary reason for compiling this guidance is increasing problems with wind induced vibration, fatigue, and even structural collapse of these support systems, as seen in Figure 1. Documented problems with these structures include questionable design and details, poor fabrication practices, and poor installation techniques.



**Figure 1. Cantilever Sign Structure Failure.**

## **2.0 SCOPE**

This document is applicable to traffic signal structures, overhead highway signs, highmast luminaries and other large light poles, and also supports used for traffic monitoring equipment of various types, such as cameras. Support structures include cantilever, butterfly, and bridge support (also known as overhead or span type supports). These structures may be installed on foundations in the ground and/or pedestals built into highway side or median barriers or built into parapets or other parts of a bridge. Wood poles and signs, concrete poles, and span wires are not directly addressed, though some of the information contained herein may assist in evaluating those structures.

These Guidelines cover structures fabricated from galvanized or painted structural steel shapes and tubes, aluminum shapes and tubes, and weathering steel. These Guidelines focus on structural aspects of the supports as opposed to sign panels, signal heads, luminaries, or their mechanical and electrical connections. In many cases, due to their location adjacent to or extending over vehicular traffic, a support failure on these structures poses a significant threat to the traveling public.

Design requirements for these structures are contained in the 4th edition of the “AASHTO Standard Specifications for Structural Supports for Highway Signs, Luminaries and Traffic Signals” (2001 Specifications) and are not directly discussed herein. In addition, several NCHRP Reports and industry specifications, which contain relevant information are listed in the references.

### 3.0 MATERIALS

#### 3.1 Material Types

Most support structures are fabricated from structural steel tubes, angles, and plate or from aluminum tubes, angles and plate. Common material specifications are shown in Table 1. Materials for bolts and anchor rods are discussed in Chapter 6.

**Table 1**  
**Materials Specifications**

Structural Steel	ASTM A36, A572 or A709 (or AASHTO equivalent)
Structural Steel (Weathering)	ASTM A572 W or A588
Steel Tubing	ASTM A500
Steel Pipe	ASTM A53, Grade B; A595 A, A135, API 52
Aluminum	
Alloy and Temper 5083 - H111/H321 5456 - H111/H116/H321 6061 - T6/T651 6063 - T5/T6	ASTM B209, B210, B211, B221, B241, B247, B308, B429

Round steel tubes may be either cold formed tubing conforming to ASTM A500 or steel pipe conforming to ASTM A53 for resistance welded pipe, or one of several other ASTM or API (American Petroleum Institute) Specifications. Multi-sided tubes are manufactured by successive bending of a plate and welding the longitudinal seam.

Aluminum members are available in a variety of alloys and tempers as is seen in Table 1. Alloys 6061-T6 and 6063-T5 are the most commonly used. In order to increase strength, aluminum is alloyed with other elements and, for the T series, heat treated. When these tempers are used in welded construction, their allowable stresses are reduced as the heat from welding reduces the beneficial heat treatment. Aluminum is both lightweight and corrosion resistant, which are beneficial when used for ancillary structures. However, the fatigue strength

of aluminum is only about 40 percent that of steels with comparable yield strengths, and the modulus of elasticity is one third that of steel, which increases member deflections.

Shop fabrication of aluminum structures generally uses welded construction. Welding electrodes are selected to match the base metal, and welding is performed in accordance with ASW D1.2, "Structural Welding Code Aluminum."

Round Tubes are commonly used in the fabrication of both steel and aluminum structures since they provide:

- ◆ Good bending resistance about any axis
- ◆ Efficient sections for compression loads
- ◆ Good torsional resistance
- ◆ Lower drag coefficient and associated wind loading

### **3.2 Corrosion Protection**

To protect steel structures from corroding some type of protective system is required. Though some ancillary steel structures may be painted, protection is most often provided by use of galvanizing or fabrication using weathering steel. Galvanizing is performed using the hot dip process.

In the galvanizing process a zinc coating is metallurgically bonded to the steel surface. The zinc layer provides both a barrier coating for the steel and galvanic protection since the zinc preferentially is consumed before the steel corrodes. The coating process involves three basic steps:

#### **1. Surface Preparation**

It is essential that the material surface be clean and uncontaminated if a uniform, adherent coating is to result. Surface preparation is usually performed in sequence by caustic (alkaline) cleaning, water rinsing, acid pickling and water rinsing.

The caustic cleaner is used to clean the material of organic contaminants such as dirt, paint markings, grease, and oil, which are not readily removed by acid pickling. Scale and rust are normally removed by pickling in hot sulfuric acid (150°F) or hydrochloric acid at room temperature. Water rinsing usually follows caustic cleaning and acid pickling.

Surface preparation can also be accomplished using abrasive cleaning as an alternative to or in conjunction with chemical cleaning. Abrasive cleaning is a mechanical process by which sand, metallic shot, or grit is propelled against the material by air blasts or rapidly rotating wheels. Abrasive cleaning is often required to remove weld flux from weld areas.

#### **2. Fluxing**

The final cleaning of the steel is performed by a flux. The method of applying the flux to the steel depends upon whether the "wet" or "dry" galvanizing process is used. Dry

galvanizing requires that the steel be dipped in an aqueous zinc ammonium chloride solution and then thoroughly dried. This “preflux” prevents oxides from forming on the material surface prior to galvanizing. Wet galvanizing uses a molten flux layer that is floated on top of the bath metal. The final cleaning occurs as the material passes through this flux layer before entering the galvanizing bath.

### 3. Galvanizing

The material to be coated is immersed in a bath of molten zinc maintained at a temperature of about 850°F. The time of immersion in the galvanizing bath varies, depending upon the dimensions and chemistry of the materials being coated. Materials with thick sections will take a longer time to galvanize than those with thin sections. Materials with a high silicon content will produce thicker coatings for equal immersions in the molten zinc than those with a low silicon content.

In addition to the effects of steel chemistry, the surface appearance and coating thickness are controlled by the galvanizing conditions. These include: a) variations in immersion time and/or bath temperature; b) rate of withdrawal from the galvanizing bath; c) removal of excess zinc by wiping, shaking or centrifuging; and d) control of the cooling rate by water quenching and/or air cooling.

Effective galvanizing requires proper detailing and fabrication practices. Detailing and fabrication must allow both flux and galvanizing zinc to reach all areas of the assembly and to properly drain. The heat of the galvanizing process can cause distortion and induce cracking if not properly addressed. Galvanizing is performed in kettles into which the item to be galvanized must fit. For larger structures, it may be necessary to fabricate them in sections, spliced after galvanizing. In other cases, structures too long for the kettle may be “double dipped”; one half (or more) of the structure is immersed at an angle and galvanized, and the process repeated to galvanize the remaining area. Unless this is done very carefully, some of the overlap area may be poorly galvanized. Double dipping also creates thermal stresses in a fabricated assembly that may lead to cracking if not properly controlled.

The protective life of a galvanized coating is determined primarily by the thickness of the coating and the severity of exposure. Environments such as exposure to industrial air pollutants or marine environments cause more rapid deterioration of the galvanized coating than, say, clean, dry rural environments.

Hot dip galvanizing of structures is normally specified to conform with ASTM A123 (AASHTO M111-80). This provides for a minimum coating thickness of 3.9 mils on material 0.25 inches and thicker. Based on data from the Hot Dip Galvanizer’s Association, service life of 30 to 40 years may be expected in relatively benign environments while only 20 to 30 years may be expected in moderately aggressive atmospheres from a 3.9 mil coating. Many ancillary highway structures have been in service long enough that the galvanizing has deteriorated. In these cases, painting may be considered to extend the structure life.

Weathering steel conforming to ASTM A588, also sometimes called by a trade name Cor-ten steel, uses nickel and chrome as alloying agents to produce a steel that can develop a protective oxide layer on the surface to minimize atmospheric corrosion. The extent of formation of the oxide layer depends on the levels of pollutants in the atmosphere as well as on

the length of time the material remains wet. Cycles of wetting followed by complete drying are needed to fully develop the protective surface. Welding electrode types should be specified to be compatible with the weathering steel and high strength weathering steel bolts are also available.

Weathering steel, while used successfully in many projects, has also experienced deterioration in unfavorable environments or due to details that did not allow proper drying. FHWA Technical Advisory T 5140.32, "Uncoated Weathering Steel in Structures", cautions against its use in the following environments:

- ◆ Those exposed to highly corrosive air pollution
- ◆ Those subject to salt spray or coastal marine salt-laden air
- ◆ Those with very high rainfall and humidity or where there is constant wetness

Areas of particular concern for corrosion of weathering steel ancillary structures are the internal corrosion of tubular members, and corrosion in the mating surface of slip joint connections. Tubular members will corrode on the inside if water or an electrolyte is able to continuously contact the surface. Members should contain drain holes and be detailed so that locations are not created where moisture can pool, or debris collect. Figure 2 shows the base of a weathering steel light pole that collapsed due to corrosion at its base. Slip joints draw water into the joint through capillary action. As this area does not dry well, pack rust develops which can generate sufficient force to split the tube vertically, starting at the bottom of the joint. Painting the slip joint surface before assembly, or sealing the bottom edge of the joint are two methods of improving the performance of this area.

Weathering steel bases may also experience premature corrosion when they are buried in soil or covered by vegetation.



**Figure 2. Failure of Weathering Steel Pole. Note the Corrosion Product.**

### 3.3 Notch Toughness

Since fatigue cracking is possible in support structures, it is important that the materials used for anchor rods and main structural members have some minimum level of resistance to fatigue, defined by notch toughness (specified with the Charpy-V-notch test, or CVN) in order to avoid brittle fracture from small cracks. Materials that meet minimum CVN requirements are usually also more weldable and less susceptible to weld defects.

Structural members and anchor rods should have CVN at least comparable to the non-fracture-critical bridge requirements; that is, the members and anchor rods should have at least 20 Joules (15 ft-lb) at room temperature and, weld filler should be used which provides CVN of at least 27 Joules (20 ft-lb) at -18°C (0°F). Most present materials used for these support structures are believed to have toughness even greater than these levels of CVN would provide, even though it is not usually specified. Even though most of the grades of steel, filler metal, and anchor rods have adequate notch toughness, there is typically an inverse relationship between notch toughness and strength such that the higher strength materials usually have lower notch toughness. This is another good reason to use only lower-strength grades.

The 2001 AASHTO Specifications require that steel "members" thicker than 13 mm (1/2 inch) meet the bridge steel CVN requirements. This is interpreted to not include anchor rods. It may be expensive or not even possible to get some anchor rods or tubular products with a supplemental CVN requirement. For example, some tubular members will be too thin to get even a sub-size CVN specimen. Since most materials meet the CVN requirement without having to actually specify it or pay for it, supplemental CVN specifications are not recommended for steel members or anchor rods other than for members thicker than 13 mm. Some exceptions may be when:

- ◆ There is the possibility of seismic loading;
- ◆ There are concerns about weldability of the steel members or anchor rods; or
- ◆ A53 Grade B pipe is used, which is not really intended for structural use.

Usually, anchor rods should conform to ASTM F1554-97, *Standard Specification for Anchor Bolts, Steel, 36, 55, and 105-ksi Yield Strength*, which is essentially the same as AASHTO M314-90, and these anchor rods have good fracture toughness. Alternatively, reinforcing bars conforming to ASTM A706-96, *Standard Specification for Low-Alloy Steel Deformed and Plain Bars for Concrete Reinforcement* may be threaded and used. Ordinary reinforcing bars conforming to ASTM A615-96, *Standard Specification for Deformed and Plain Billet-Steel Bars for Concrete Reinforcement* should not be used for these support structures because of possible low toughness.

Using materials with additional notch toughness (above these minimum levels) would not significantly increase the time to failure of the structure by fatigue. This is because cracks grow at an exponential rate, and 95 percent of the life is consumed while the crack size is less than a few millimeters. Even though additional fracture toughness may correspond with a greater crack length at the time of failure, it does not correspond with a significantly longer time to failure.

This is also the reason why, unless there is a suspected crack or there have been cracks in similar details in similar structures, it is usually not cost-effective to perform ultrasonic testing or other non-destructive testing (other than visual) on anchor rods or other details to locate fatigue

cracks. There is only a small window of time when the cracks are both large enough to detect and small enough to not yet cause fracture. In some states; however, ultrasonic testing is routine on four bolt bases of cantilever structures and partial testing is carried out on up to eight bolt bases.

#### 4.0 LOAD EFFECTS

##### 4.1 General

Design loads for ancillary structures include dead and live loads, ice loads, and wind loads. For most structures, design will be governed by wind loads.

Dead load includes the weight of the structural support itself, as well as the weights of signs, luminaries, traffic signals, lowering devices and any other appurtenances permanently attached to, and supported by, the structure. Temporary loads that may occur during maintenance should also be considered as dead load. AASHTO also requires that a live load be applied to any walkways and service platforms or ladders.

An ice load, equivalent to a layer of ice 0.60 inches thick, is applied to all surfaces for structures located in regions considered susceptible to ice buildup. This area is shown in Figure 3-1 of the AASHTO Specifications, but generally includes all of the continental United States with the exception of a band running from the California coast and extending across the lower half of the southernmost states, plus all of Florida.

The primary loads applied to sign, signal, and luminaire structures are due to natural winds. The structure must not only have sufficient strength to withstand the maximum expected wind loads, normally a once in 50 year maximum, but also the fatigue effects of fluctuating winds of lower force. There are four wind-loading phenomena that can lead to vibration and fatigue: natural wind gusts, truck-induced gusts, vortex shedding, and galloping. Each type of structure (e.g., signal, sign, or luminaries) is susceptible to either two or three of the four wind loads, as is shown in Table 2. The interaction of the support structure with the wind is dependent on the structure's stiffness and shape. For instance, galloping which can occur in cantilever signal structures, does not occur in bridge support configurations.

**Table 2**

**Susceptibility of Types of Support Structures to Various Wind-Loading Phenomena**

Type of Structure	Galloping	Vortex Shedding	Natural Wind	Truck Gusts
Cantilevered Sign (one- or two-chord)	X		X	X
Cantilevered Sign (four-chord)			X	X
Bridge Support (Sign or Signal)		*	X	X
Cantilevered Signal	X		X	X
Luminaries		X	X	

Note: X indicates structure is susceptible to this type of loading

\* Vortex shedding has occurred in monotube bridge supports and can occur in cantilevered structures if the sign or signal is not attached, such as could occur during installation.



The high flexibility and low damping of cantilevered support structures makes them susceptible to resonant vibration in the wind. The flexible cantilevered structures have low natural frequencies of about 1 Hz (period of vibration of 1 second), which is in the range of typical wind gust frequencies. The closeness of the wind gust frequencies to the natural frequency causes resonance or dynamic amplification of the response. In addition, typical damping ratios in these structures are extremely low (less than one percent of critical damping). The low damping increases the amplification of the wind-induced vibrations.

Usually, the greater the length of the cantilevered mast arm, the more susceptible the support structure will be to wind-induced vibration. In recent years, the span length of the cantilevered mast arms has increased significantly. One example is a 22-m (72-ft) long cantilevered signal support structure near the University of Tampa, which vibrates frequently due to its extreme flexibility.

Personnel involved in installation, inspection, maintenance, and repair of ancillary support structures should understand the wind loading and response of various support structures. This will enable them to recognize these problems in the field and have a better understanding of the important reasons for quality control during the structure erection phase.

#### **4.2 Natural Wind Gusts**

The most common type of wind-induced vibration in support structures is from ordinary wind gusts or fluctuations of the wind velocity. In the 2001 Specifications, these gusts are referred to as natural wind gusts to distinguish them from truck-induced wind gusts. Natural wind gusts exert a fluctuating force that is primarily horizontal, and the resulting motion of the mast arm is also primarily horizontal, although there is often a significant vertical motion as well. In the 2001 Specifications, the natural wind gust pressure is applied horizontally to the projected frontal area of all surfaces, including the structural members, as well as the sign and signal attachments.

In cases where fatigue cracking was caused by natural wind gusts, cracking developed over a period of at least several years. In light poles, the connection of the arm supporting the lights to the pole top has cracked. In cantilevered sign and signal support structures, the cracks will usually manifest at the connection of the mast arm to the pole, with cracks forming along the sides of the connection. Natural wind gust loading has also caused cracks at truss connections and at the base of the pole, at the weld joining the pole to the base plate, at the top of the stiffeners, at hand holes, or at the anchor rods.

As shown in Table 2, all structure types are potentially susceptible to natural wind gusts, which act on all members of the structure as well as the attachments. The most flexible and most lightly damped structures are more susceptible, however.

Support structures in certain areas of the country that are very windy are particularly susceptible to vibration and fatigue from natural wind gusts. Typically, these are places where the mean annual wind velocity is greater than 5 m/s (10 mph).

These places where there are frequent constant winds, and support structures are at risk for fatigue cracking due to natural wind gust loading, are not the same places with the maximum peak wind velocities that are identified on wind maps, such as those in ASCE 7-98. These maps show the maximum wind speed that occurs over a 50-year period that is used for strength design. It is noteworthy that there are very few fatigue failures of cantilevered sign and signal

supports after hurricanes or other large storms. These once-in-a-lifetime wind gusts have little influence on fatigue.

The fatigue-limit-state natural wind gust loads in the 2001 Specifications are derived for winds that are exceeded about 2 hours each year. Such areas, surprisingly, are not necessarily those with occasional very high winds such as hurricanes or tornadoes. For example, the four places in the United States with the greatest wind velocities that are exceeded at least 2 hours per year are:

- ◆ Tatoosh Island, Washington: 28 m/s (62 mph)
- ◆ Clayton, New Mexico: 24 m/s (53 mph)
- ◆ Point Judith, Rhode Island: 24 m/s (53 mph)
- ◆ Cheyenne, Wyoming: 24 m/s (53 mph)

### 4.3 Truck-Induced Wind Gusts

The passage of trucks beneath support structures induces both horizontal and vertical gust loads on the structure, creating a motion that is primarily vertical but may also include a significant horizontal component as well. The magnitude of the horizontal truck gust is negligible relative to the natural wind gust and is therefore ignored in the specifications. The vertical truck gust load in the specifications is an equivalent static pressure range applied to the underside of the mast arm or truss and any attachments. Due to the large depth of variable-message signs (VMS) in the direction of traffic flow (up to 1.2 m for older signs), the support structures are the most susceptible to truck-induced wind gust fatigue because they present a large area in the horizontal plane, as seen in Figure 3.



**Figure 3. Truck Passing Under VMS.**

Fatigue cracking from truck-induced wind gusts usually develops over a period of several years. However, one case of a failure of a cantilever VMS structure, reported by DeSantis and Haig, was to a structure less than 1 year old. The cracks will usually manifest at the connection of the

mast arm to the pole, at truss connections; and at the base of the pole to the weld joining the pole to the base plate, at the top of the stiffeners, at hand holes, or at the anchor rods.

The truck-gust pressure is proportional to the speed of the trucks, so signs located on major highways are more susceptible than those where the trucks are traveling slowly. Also, there is a vertical gradient for the truck-induced gust pressure, so the greater the clearance between the tops of trucks and the bottoms of the signs, the less the susceptibility to truck-induced vibration. The truck-gust loads essentially go to zero at a height of 10 m (32.8 ft) above the roadway.

#### 4.4 Vortex Shedding

Vortex shedding is the shedding of vortices on alternate sides of a symmetric member (i.e., one without any attachments). Vortex shedding can result in resonant oscillations of a pole in a plane normal to the direction of wind flow as shown in Figure 4(A). In the 2001 Specifications, the vortex shedding pressure range for fatigue design is applied horizontally to the projected area of one side of the pole to calculate the fatigue stress ranges in the details.

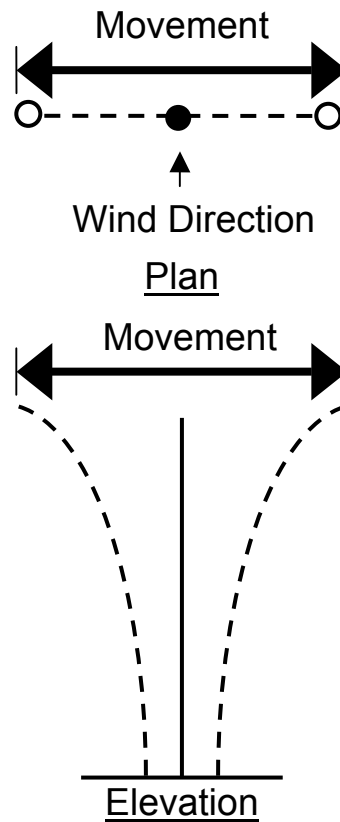

A. Vortex Shedding

**Figure 4A. Wind Effects**

As shown in Table 2, only luminaries support structures (i.e., light poles) have exhibited problems from vortex shedding. However, other simple cantilever poles, such as camera poles may also be susceptible. Luminaire support structures may occasionally exhibit excessive

vibration from natural wind gusts. However, if there is a vibration problem with luminaire supports, it is typically due to vortex shedding.

In some cases, severe vibration from vortex shedding has persisted long enough to cause fatigue cracking. This may not require a long time. For example, in the case of some aluminum light poles that failed after a windstorm in New Jersey, it was found that the fatigue cracks initiated and propagated to failure in just one night. In light poles, cracks are usually observed at the base of the pole or at the weld joining the pole to the base plate or transformer base. If there are stiffeners or gussets reinforcing the pole to base plate connection, then the cracks will typically form at the tops of the stiffeners. In some cast aluminum pole bases, the cracks will occur at various details in the castings. If there are hand holes, cracks may appear around the perimeter of these. Cracked anchor rods have also occurred.

Vortex shedding tends to occur with steady continuous winds at a critical velocity. The velocity need not be very high, but it has been found that significant vibration does not occur unless the velocity is greater than 5 m/s (10 mph). The periodic frequency of the vortex shedding can lock in on the natural frequency of the pole, resulting in very large alternating forces acting transverse to the wind flow direction. There are videotapes of luminaire supports vibrating so severely that the amplitude of the vibration was on the order of the pole diameter. Vortex shedding may result in frequent burnouts of the light filaments. Occasionally, the vibration is so severe that fatigue cracks will appear.

Although vortex shedding can "lock in" and continue as the velocity increases or decreases slightly, if the velocity changes by more than 20 percent, the vortex shedding will stop. Gustly variable winds, such as might occur in a severe storm typically will not cause vortex shedding. In fact, if the wind velocity is greater than 15 m/s (35 mph), the wind is generally too turbulent for vortex shedding to occur. In summary, the winds that are dangerous for vortex shedding are steady winds in the velocity range 5 to 15 m/s (10 to 35 mph).

Recent studies have verified that vortex shedding can occur in tapered as well as prismatic circular poles with almost any diameter. (Note: this is contrary to some statements in the 2001 Specifications) In a few cases, sign and signal support structures have exhibited vortex shedding on the mast arms before the attachments (signs or signal heads) were mounted. After mounting, this is no longer a problem. Consequently, it is recommended that mast arms never be erected before these attachments are mounted. NCHRP Report 469 reports that vortex shedding of long monotube bridge support structures has also occurred.

#### **4.5 Galloping**

Galloping is different than vortex shedding but also results in large-amplitude, resonant oscillations perpendicular to the direction of wind flow as shown in Figure 4(B). Unlike vortex shedding, galloping occurs on asymmetric members (i.e., those with signs, signals, or other attachments) rather than circular members. Therefore, it is the mast arms rather than the poles that are susceptible to galloping. Galloping has caused mast arms to move up and down with a range greater than 1 m. According to NCHRP Report 469, a large portion of the vibration and fatigue problems that have been investigated for cantilevered sign and signal support structures were caused by galloping.

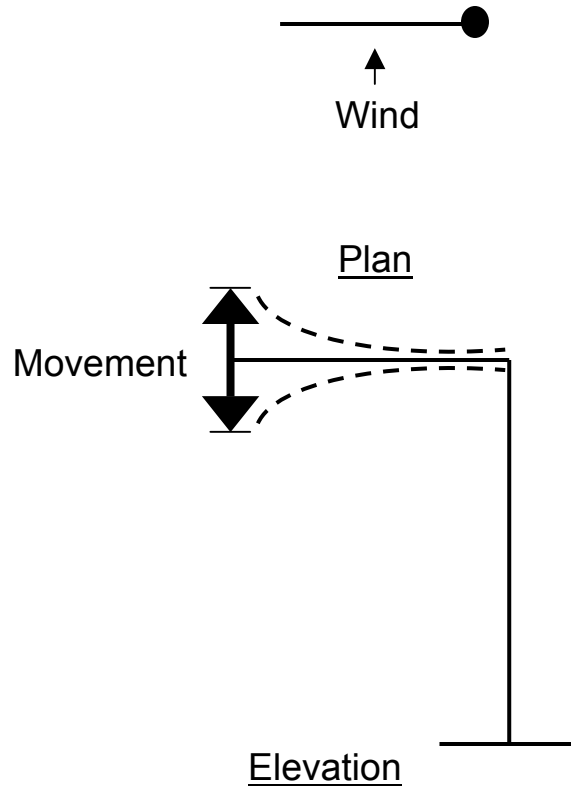

## B. Galloping

**Figure 4B. Wind Effects**

Galloping is caused by the attachments (i.e., signs/signals). The number of signs and signal heads, their configuration, area, connection detail, and the direction of wind flow significantly influence the susceptibility for galloping. Signal attachments configured with backplates and subjected to flow from the rear are most susceptible to galloping. However, all types of signal heads and signs have been observed to be affected by galloping, even those with louvered backplates.

Galloping also requires uniform steady winds rather than gusty winds. However, in contrast to vortex shedding, galloping can continue over a large range in wind velocity. The mode of vibration for galloping is swaying of the mast arm in the vertical direction. This mode typically has a frequency closer to 1 Hz (1 second period). Higher modes of vibration have not been observed. Galloping requires twisting of the mast arm as well as vertical motion. Consequently, flexible monotube cantilever support structures are particularly susceptible to galloping. As noted above, monotube bridge support structures may be susceptible to vortex shedding; therefore, one can assume that these structures may also be susceptible to galloping from the sign or signal attachments. However, typical bridge support structures where the sign bridge consists of three-dimensional, three-chord or four-chord trusses are not susceptible to vortex shedding or galloping.

In the 2001 Specifications, the galloping pressure is applied vertically (like a shear stress) to the projected frontal area of all sign and signal attachments. The galloping loads are quite severe, so when they are applicable, they will typically govern the fatigue design. Therefore, mitigation devices will have significant cost benefits in reducing the effects of galloping as opposed to natural wind gusts or truck-induced wind gusts.

In most cases that have been investigated, the fatigue cracking that has occurred from galloping has developed over a long period of a year or more where there may have been many days of winds that caused galloping. In cantilevered sign and signal support structures, the cracks will usually manifest at the connection of the mast arm to the pole or at the base of the pole. In truss mast arms, the cracks may form at the truss connections, usually those closest to the pole. If there is a flanged splice detail in the mast arm close to the pole, this may also be a critical location where cracks may form. At the base of the pole, cracks may form at the weld joining the pole to the base plate. If there are stiffeners or gussets reinforcing the pole to base plate connection, then the cracks will typically form at the tops of the stiffeners. If there are hand holes, cracks may appear around the perimeter of these. Cracked anchor rods have also occurred.

Cantilevered sign support structures with mast arms fabricated in three- or four-chord trusses have also never been reported to vibrate from vortex shedding or galloping. Apparently, these three-dimensional truss mast arms are sufficiently stiff to resist galloping. However, there are many reported instances of cantilevered two-chord trusses with signs and signals galloping. Typically, the longer the cantilever mast arm, the more susceptible to galloping.

#### **4.6 Fatigue**

Fatigue resistance of particular details is determined by testing full-scale structural members under cyclic loads. The loading is characterized in terms of the nominal stress in the structural member remote from the welds or bolts in the detail. The nominal stress is conveniently obtained from standard design equations using member forces and moments. Testing has indicated that the primary effect of constant amplitude loading can be accounted for in the live-load stress range (i.e., the difference between the maximum and the minimum stress in a loading cycle). Thus, it is the fluctuation of the stress and not the absolute value of the stress that affects fatigue. The constant dead load stress does not affect fatigue.

The strength and type of steel have a negligible effect on the fatigue resistance expected for a particular detail. The welding process and minor deviations in weld quality from AWS D1.1 standards, while important, also do not typically have a significant effect on the fatigue resistance. The independence of the fatigue resistance from the type of steel and weld filler metal greatly simplifies the development of design rules for fatigue since it eliminates the need to generate data for every type of steel. As previously pointed out, the fatigue resistance of aluminum is significantly less than that of steel.

Fatigue failure of a support structure basically occurs because the stress ranges resulting from the wind or truck-induced gusts exceed the fatigue thresholds at critical details. Usually, these failures cannot be blamed on weld defects; rather, they are an indication that the structure is not adequately designed for the fluctuating loads and is experiencing excessively large stress ranges. This is a good reason to believe that other similar structures will soon be having similar cracking problems. Therefore, if a fatigue failure has occurred in a structure, one cannot be

complacent about inspecting similar structures. All similar structures should be intensively inspected immediately.

It is a commonly held, but incorrect assumption that cracks may be caused by overloading the structure. In some cases, large variable message signs have been placed on a truss designed for flat green signs, and then fatigue problems have occurred. These problems are likely due to the increased area of the sign, which increases the gust load ranges and the associated stress ranges from wind and trucks, rather than from the increased dead load stress.

In the 2001 Specifications, the fatigue design provisions for support structures are given in Section 11. These fatigue design provisions are similar to those in the bridge specifications. The fatigue design procedures are based on control of the nominal stress range and knowledge of the fatigue threshold of the details. Various details are shown in Figure 11-1 of the 2001 Specifications. Each of these details is assigned a "Stress Category" in Table 11-2, and the fatigue threshold stress range for each category is given in Table 11-3 of this Specification. Support structures should be designed so that the stress ranges due to the fatigue design loads are less than the fatigue thresholds for each detail, thus ensuring that fatigue will not occur even for a large number (hundreds of millions) of applied load cycles. Design calculations should be prepared and stamped by a professional engineer explicitly showing the fatigue design as well as the traditional allowable stress design for strength.

Since the fatigue resistance of various grades of steel and anchor rods is the same, it typically is not cost-effective to use high-strength steel, higher than 420 Mpa (60 ksi) yield strength. If the dimensions of the members or anchor rods are decreased to take advantage of the high-strength steel for the maximum strength design loads, the stress ranges under the fatigue design loads will increase and fatigue will become more of a problem.

## **5.0 ERECTION OF SIGN, SIGNAL, AND LIGHT SUPPORT STRUCTURES**

### **5.1 General**

This section recommends procedures for the erection of support structures. Construction of the concrete foundations is not covered. However, guidance on grouting of base plates and the proper installation of anchor rods is presented.

For this discussion, Quality Control (QC) refers to all means and methods utilized by a contractor and/or a subcontractor to assure ancillary structures are properly fabricated, erected and constructed. Quality Assurance (QA) refers to all means and methods utilized by a public owner or an agent acting on their behalf to assure adequate QC is employed by the contractor and that satisfactory quality in the work is achieved.

Numerous defects found during condition assessment inspections have been attributable to poor fabrication or erection practices. Proper erection is the responsibility of the erection contractor. The erection contractor should perform inspection and testing to verify that installation is in accordance with the project specifications. Records should be kept of the dates and results of any inspection, and these records should be available for the Engineer of Record or their representative to review. The Engineer of Record may require that their representative witness the installation and inspection. Inspection by the owner, or its representative, during erection is strongly recommended.

## **5.2 Shop Inspection**

Shop inspection of ancillary structures is encouraged, particularly for welded cantilever sign and overhead bridge structures. The inspections should assure that the structures conform to the design drawings and that details such as drain holes, boltholes, connection details and welds are properly executed. Overall member configuration, alignment, and coating condition should also be checked. In many instances, detailed design of ancillary structures is provided by the vendor, within overall guidance of general configuration plans prepared by the owner. Thus a wide variety of details and fabrication methods are normally encountered in the finished structures. Vendor detail drawings and calculations should be reviewed for conformance with the 2001 Specifications and to identify poor details prior to starting fabrication.

The 2001 Specification requires weld inspection, which should be performed and documented by the fabricator. Section 5.15 of the Specifications provides requirements for steel structures, while Section 6.9 applies to aluminum structures. Weld quality for steel structures should conform to AWS D1.1, Structural Welding Code - Steel, and for aluminum structures to AWS D1.2, Structural Welding Code - Aluminum. For tubular aluminum structures, workmanship requirements for Class I structures are the minimum, while Class II should be considered for critical structures.

Due to the types of joint configurations and welds found in ancillary structures, weld inspection requirements contained in current fabrication specifications are not sufficient to ensure defect free welds during shop fabrication. This is one reason that close field inspection of ancillary structures to find detectable cracks is particularly important. NCHRP Report 469, "Fatigue-Resistant Design of Cantilevered Signal, Sign, and Light Supports," contains a discussion of the Specification requirements for welding inspection and their effectiveness.

## **5.3 Preparation for Erection**

The erection contractor should be responsible for assembling design and fabrication documents and having them available for review by the owner or their representative. The design and fabrication documents should include a set of design drawings; shop drawings; the name and contact information for the designer/consultant of record; design calculations (stamped by a professional engineer explicitly showing the fatigue design as well as the traditional allowable stress design for strength); the name and contact information (including location of plant) of fabricator of record; welding procedure specifications; inspection reports; and copies of material mill certificates for the anchor rods, structural bolts, and the main members (not including stiffeners, base plates, flange plates, and other small plates). As an option, the owner may elect to have some of this information, not directly needed for erection, submitted directly to him/her. The erection contractor, considering the weight and stability of the pieces to be erected, should carefully plan the erection procedure for each job. Light poles, including light supports with relatively short cantilevered arms, may be fully assembled on the ground and erected in one piece. Cantilevered sign and signal supports should be erected in two pieces. It has been found that it is nearly impossible to properly tighten the double-nut anchor rod connection when a completely assembled cantilevered support structure is suspended from the crane. Bridge type structures should have the end frames erected, followed by the bridge.



Prior to erection, the separate parts of the structure, posts, end frames, mast arms, and trusses, should be inspected for bent or damaged members, damaged coatings, distortion, and defective fabrication that would affect proper erection. Structures can be damaged during shipment as well as by improper unloading and storage at the site. Localized defects in the galvanizing coating should be repaired in accordance with the requirements of ASTM A780, "Standard Practice for Repair of Damaged and Uncoated Areas of Hot-Dip Galvanized Coatings."

In addition to establishing that the structure was properly fabricated, the contractor should visually inspect the structure for cracks. Cracks may occur during fabrication or galvanizing of the structures. In addition, fatigue cracks may occur in structures from the loads they experienced in transport, as has happened with several aluminum trusses with tube to tube welded connections. Fatigue cracks will generally occur between bolt holes or along the toe of the welds parallel to the weld axis. Longitudinal seam welds, any hand holes or other attachments, or any splices or joints should be inspected closely. All defects in the structure should be reported to the owner or their representative so that proper repairs may be authorized.

If it is not clear whether the visual indication is a crack or possibly just a crack in the coating or a scratch, the indication should be further investigated using magnetic particle (MT) testing or dye-penetrant (PT) testing. These testing procedures are explained in detail in AWS D1.1. It is generally not worthwhile to inspect areas using one of these methods unless there is a good reason to suspect there is a crack. Ultrasonic testing may be useful in some circumstances, but generally the cracks will have penetrated through the thickness of the member, and the MT and PT methods can find them more economically. Enclosed tubes, especially the diagonals and verticals in trusses, can rupture from the galvanizing (if adequate vent holes are not used or become clogged). If these tubes fill with water, they should be drained by drilling a 13-mm (0.5-inch) diameter hole near the bottom of the tube, but at least 25 mm (1 inch) from the welded connection. If the water remains undrained, it can accelerate corrosion or rupture the tube if it freezes.

It should be verified prior to beginning erection that there will be no fit-up problems when the parts of the structure are assembled in the field. The slope of the surfaces of parts in contact with bolt heads or nuts, and the faying surfaces, should be equal to or less than 1:20 with respect to a plane that is normal to the bolt axis. However, even if the surfaces are within tolerances, 100-percent mating between the two flanges will usually not be achieved. The structure should be rejected, however, if more than 25 percent of the surface area is visibly not in firm contact after snugging the bolts. This contact surface is discussed further in Section 6.4.

The erector should verify that the foundations are set to the proper elevation and anchor rods are set in the correct pattern and orientation, are of the correct size, and are plumb with the specified extension and thread length above the top of concrete, as seen in Figure 5.



**Figure 5. Foundation Ready for Structure Installation.**

The anchor rods generally should not be subjected to erection or service loads until the concrete reaches its 28-day specified strength. In some cases, with the approval of the owner or owner's Engineer, the post may be attached to the anchor rods after as few as 7 days.

If necessary, camber should be built into the support structure. The base plate should always be designed to be level. The support structure base plate should never be sloped on the anchor rods to achieve a camber, because the misalignment of the base plate will make it nearly impossible to properly tighten the anchor rods.

An ancillary structure inventory database should be established and the inventory number should be clearly placed on the support structure. The inventory number is most often stenciled on with paint, though numbers may also be stamped into the post or even magnetic bar codes can be attached. The design, materials, and fabrication documents discussed previously should be filed in a way that they are accessible and linked to the database. The date of erection should be recorded and the inspection results and any repairs or corrective measures taken should be explained in detail in the database.

#### **5.4 Erection Procedure**

Prior to starting actual erection, all traffic control and other safety measures as required by the project specifications must be in place and reviewed for compliance. Erection generally requires at least some lane closures, and may involve short-term total road closures. In areas of high traffic, erection may have to be performed at night, requiring temporary lighting for both a safe and complete installation.

The actual erection process begins by placing and leveling the leveling nuts. Typically, the bottom of the leveling nuts are set approximately 6 mm (0.25 inches) above the top of the concrete. The posts or end frames are then erected on the anchor rods (Figure 6), being careful not to damage the threads on the anchor rods. The base plate should be leveled by bringing up the leveling nuts on the low sides. To minimize shear and bending in the anchor rods, the bottom of the leveling nuts must not be more than one anchor rod diameter above the

top of the concrete. Finally, the anchor rod nuts should be tightened. Recommendations for tightening are presented later, in Section 6.5.



**Figure 6. End Frame Being Set Onto Its Foundation.**

After the anchor rod nuts are properly tightened, the post or end frame is released from the crane. For light poles, the erection is now complete, except for the post-erection retightening of the anchor rods, as discussed in Section 6.9.

For cantilevered signal and sign support structures, the erection continues with the mast arm or truss. The cantilevered mast arm or truss is balanced on the crane and is brought up to position and bolted to the post.

For sign bridges, the sections (if there are more than one) are normally connected to one another on the ground and set in one lift. Lifting points must be located so that the bridge is not overstressed during lifting, (Figure 7). With the bridge set on the end supports, alignment should be verified and connections brought up to final tightness. With the cantilever arm, or bridge in position, a check of overhead roadway clearance should be performed and documented.

Signs, signals, and other attachments are normally attached to the cantilever arm or sign bridge on the ground before erection. Even very large heavy variable message sign boxes should be attached to their supporting members on the ground, and this can be done off site. If the attachments are not attached to a cantilever structure when it is erected, they should be attached immediately after erection. This is because the bare mast arms with no attachments are vulnerable to vortex shedding, which can quickly become destructive.



**Figure 7. Assembled Truss Being Lifted Into Place.**

## **6.0 BOLTED CONNECTIONS**

Sign, signal, and lighting structures utilize a variety of bolted fasteners in their construction. These range from large anchor rods and high strength bolted structural connections to “secondary” fasteners for signs, wind beams, saddles, and the like. Fasteners also include U-bolts, bolted clips, and similar items. While procedures for installing high strength bolts are established in AASHTO, and recommended procedures for anchor rod nut installation are provided herein, installation practices for other types of bolted fasteners varies.

Ancillary structures are subject to vibration due to fluctuating wind loads. Unless properly tensioned, this can cause fasteners to become loose and contribute to their failure. Though the implication of failure of an anchor rod or bolt in a structural connection may seem apparent, even secondary fasteners that fail can lead to sign breakage and small items falling into traffic. Connections should be designed with due consideration of the fatigue stresses induced by variations in wind loads.

### **6.1 High-Strength Bolts**

The design, specification, handling, installation, and inspection of bolted joints in steel support structures should be in accordance with the *Specification for Structural Joints Using ASTM A325 or A490 Bolts* dated June, 2000 by the Research Council on Structural Connections (RCSC). Only a few points especially important for support structures are mentioned in these Guidelines. The Federal Highway Administration Report No. FHWA-SA-91-031, “High-Strength Bolts for Bridges” provides an in depth treatment of bolt supply, installation, and testing (this manual is available for download at [fhwa.dot.gov/bridge](http://fhwa.dot.gov/bridge)). The U-bolts and other details for connecting luminaires, signs, and signal heads to the structure are not discussed. The manufacturers design these details, and there have been few problems with these details in the past.

Structural joints for galvanized steel sign, signal, and light support structures should only utilize galvanized ASTM A325 high strength bolts or galvanized ASTM F1852 twist-off-type, tension control bolt assemblies. The joints should be between steel members, and it is essential that the joints be properly pretensioned to resist vibration. These bolts have a very high strength so that they can supply high forces to compress the joint when they are tightened to their prescribed pretension. These joints actually carry load through compression-generated friction on the faying surfaces rather than through the bolt. The job of the bolt is to maintain the pretension and the associated precompression of the faying surfaces.

When a pretensioned joint is subject to cyclic fatigue loads, it acts as if the pieces pressed together were actually monolithic (i.e., the bolts themselves feel only about 20 percent of the load range), with the majority of the load range transferred through the faying surfaces. When a bolted joint is not properly pretensioned, all the load range is transferred through the bolts and they may quickly fail by fatigue.

Galvanized ASTM A325 bolts and related washers and nuts are available either hot-dip galvanized or mechanically galvanized. Hot-dip galvanizing is recommended as it provides a heavier coating with corresponding increased life.

Heavy-hex nuts should meet the requirements of ASTM A563 (Grade DH; galvanized and lubricated) or ASTM A194 (Grade 2H; galvanized and lubricated). Heavy-hex nut dimensions should meet the requirements of ANSI/ASME B18.2.6. Flat galvanized circular washers should meet the requirements of ASTM F436. Washers should be used under the nut. If the bolt head is to be turned during the tightening procedure, then a washer should also be provided under the head. Lock washers should never be used with high strength bolts. For oversized holes, plate washers 8 mm (5/16 inch) should be used rather than flat washers. Plate washers should be structural grade steel and should be galvanized, if used with galvanized fasteners.

Lock washers should not be used with high strength bolts. Their variability of deformation under load does not provide for proper bolt installation tension.

Compressible-washer-type, direct-tension indicators should meet the requirements of ASTM F959. When the direct-tension-indicator (DTI) is used under the nut, an ASTM F436 washer should be placed between the bolt and the direct-tension indicator. When the direct-tension-indicator is used under the bolt head, an ASTM F436 washer is required under the DTI when the DTI is placed on an oversized hole and between the bolt head and the DTI when the bolt head is the turned element.

The bolt length used in a connection should be such that the end of the bolt is flush with or projecting beyond the face of the nut when properly installed.

## **6.2 Stainless Steel Fasteners**

Connections for stainless steel structures, which are rare, and aluminum structures utilize stainless steel bolts and related fasteners. Stainless steel offers excellent corrosion resistance.

Stainless fasteners are most often supplied from American Iron and Steel Institute (AISI) Type 304 or 316 stainless material. Type 304 is the most common. Nuts and washers should match the steel type of the bolt or fastener. Stainless fasteners should conform to the requirements of ASTM F593, "Standard Specification for Stainless Steel Bolts, Hex Cap Screws, and Studs" and

ASTM F594 “Standard Specification for Stainless Steel Nuts.” Stainless steel bolts are supplied either hot finished or cold finished. Cold finished Type 304 and 316 bolts have an ultimate tensile strength of 620 MPa (90 ksi), versus 516 MPa (75 ksi) for hot finished. However, cold finished bolts are only supplied if specifically specified and are not normally “off-the-shelf” items.

Since installation tension for stainless fasteners is not as high, or as well controlled, as it is for high strength steel bolts, the use of lock washers is common with stainless fasteners. Lock washers are placed under the nut and help to reduce loosening due to structure vibration and load fluctuation.

### **6.3 Aluminum Fasteners**

Aluminum fasteners are sometimes used for miscellaneous applications, such as sign connections. Aluminum bolts are not generally used in structural connections, even on aluminum sign structures, due to a tendency to stretch and hence loosen under cyclic tension loadings.

Aluminum bolts should conform to ASTM B316 “Structural Specification for Aluminum-Alloy Rivet and Cold Heading Wire and Rods.” Bolts are available in several alloy-tempers, with 2024-T4 and 6061-T6 the most common. Off-the-shelf bolts are typically alloy-temper 2024-T4, which has an allowable shear stress of 96 MPa (14 ksi) and an allowable tension stress of 158 MPa (23 ksi) as given in the “Aluminum Design Manual” published by the Aluminum Association.

### **6.4 Installation of Bolts and Fasteners**

All bolts and miscellaneous fasteners must be installed in accordance with established industry practice or manufacturer’s requirements. Though not desirable, some procurement practices may result in sign structures being erected by firms with little experience in proper installation of high strength bolts. In addition, unless a contractor is erecting a group of sign structures, only a few high strength bolts may be needed. Where the quantity of fasteners is small, it may not be realistic to expect the same bolt documentation and testing as would be provided on a steel bridge erection project.

Fastener components should be protected from dirt and moisture in closed containers at the site of installation. Fastener components should not be cleaned of lubricant that is present in the as delivered condition. Components that accumulate rust or dirt resulting from plant or job-site conditions should not be incorporated into the work. Galvanized bolts that have been fully pretensioned shall not be reused.

A common bolted connection in ancillary structures consists of bolted flange or face plates that match face-to-face. Such connections occur at truss chord splices, long mast arm splices, arm to pole connections, and similar locations. According to fabricators, it is almost impossible to achieve a perfectly flat faying surface on the flanged connection that mates at the exact angle with a perfectly flat faying surface on the opposing flange. The fabricator should select a weld type and procedure for the plate to tube (or member) connection that minimizes misalignment and distortion of the faying surfaces. As stated above, the slope of the surfaces of parts in contact with the bolt head or nut, and the faying surfaces, should be equal to or less than 1:20 with respect to a plane that is normal to the bolt axis, but 100-percent mating between the two flanges will usually not be achieved. Compressible materials (such as gaskets, insulation, or

sheets of other metals) should not be placed between these flanges, even to try to achieve better contact. Tightening of bolts should be performed in a manner that brings the faying surfaces up “evenly.” For flange type connections, a star tightening pattern as shown in Figure 8 is recommended.

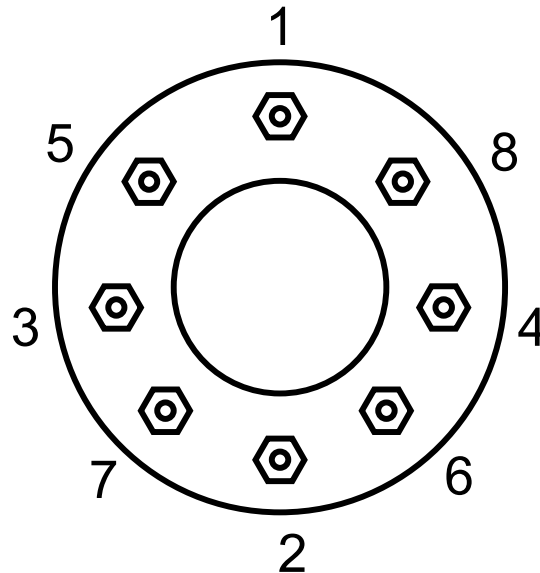

**Figure 8. Star Pattern Tightening Sequence.**

For high strength bolted joints, according to the RCSC, the surfaces need to be brought into firm contact, but it is acceptable to have isolated areas where there is no contact. The fact that gaps may exist in the faying surfaces does not prevent the bolt preload from being developed. The end plate thickness is enough to bridge the gaps and develop the desired bolt tension. The snug-tightened condition is defined by the RCSC as the tightness that is attained with a few impacts of an impact wrench or the full effort of an ironworker using an ordinary spud wrench to bring the plies into firm contact. The structure should be rejected if there is more than 25 percent of the surface visibly not in contact after snugging the bolts. The Engineer of Record may approve the use of steel shims or repairs to the structure to correct this problem.

For high strength bolted joints using ASTM A325 galvanized bolts, allowable methods of installation, to develop the required pretension, include the turn-of-nut method, calibrated wrench method, twist-off-type tension-control bolt method, or direct-tension-indicator method. These are described in Section 8 of the RCSC Specification. Procedures for each installation method are detailed in report FHWA-SA-91-031, High Strength Bolts for Bridges, Appendices A2 through A6. A detailed coverage of high strength bolting may also be found in the Steel Structures Technology Council (SSTC) Structural Bolting Handbook.

Pre-installation verification testing should be performed using a Skidmore-Wilhelm device as indicated in Section 7 of the RCSC Specification. However, since ancillary structures may contain only a few high strength bolts, this testing is often not performed. High strength bolts should be inspected for proper bolt tightening as required by the RSCS Specification for the chosen method of bolt installation. The inspection verification data should be provided to the owner’s representative. Where connections are made up overhead with one piece suspended

from a crane, pretensioning and inspection should be performed prior to releasing the load thus minimizing induced stresses into the joint.

Installation methods for fasteners other than high strength structural bolts are not standardized. As with high strength bolts, proper joint fit-up that does not induce bending into the bolts, selection of proper bolt length to allow full nut engagement, and use of washers must be adhered to. It is recommended that stainless and mild steel bolts be installed to minimum torque values. This at least assures a minimum bolt tension and consistency between multiple bolts in a connection. It should be noted that it could be beneficial to the owner to perform torque/tension testing on nonstructural bolts to establish the tension being provided for specified torques. This would allow for more complete joint evaluation.

The Specialty Steel Industry of the United States (SSIUS) recommends that stainless bolts be tightened to an installation torque value that varies with bolt size as shown in Table 3.

**Table 3**

**Stainless Steel Bolts**

Size Dia, mm (in)	Installation Torque	
	Type 304 KN-mm (ft-lb)	Type 316 KN-mm (ft-lb)
12 (1/2")	59 (43)	62 (45)
16 (5/8")	127 (93)	133 (97)
20 (3/4")	175 (128)	181 (132)
24 (1")	393 (287)	410 (300)

Galvanized mild steel bolts and threaded fasteners such as U-bolts are also used in ancillary structures. These include treaded fasteners conforming to ASTM A307 as well as to the Society of Automotive Engineers (SAE) Grades 1 and 2. Typical ultimate tensile strengths are from 420 MPa (60 ksi) to 440 MPa (64 ksi). These fasteners should be installed to the torque values shown in Table 4, and verified using a properly calibrated torque wrench.

**Table 4**

**Installation Torque for Mild Steel Fasteners**

Bolt Size, Dia. mm (in)	Minimum Torque KN-mm (ft-Lb)
10 (3/8)	20 (15)
12 (1/2)	50 (37)
16 (5/8)	101 (74)
20 (3/4)	164 (120)
22 (7/8)	260 (190)



Aluminum fasteners are not recommended for structural connections. Miscellaneous or secondary fasteners of aluminum should be installed to torque valves supplied by the manufacturer.

## 6.5 Anchor Rods

### 6.5.1 General

Anchor rods provide attachment of the structure to its foundation. They can carry large forces, particularly for cantilever structures where overturning is resisted by a moment at the base which is carried through the anchor rod group. The design and proper installation of anchor rods has traditionally received little technical guidance as it fell wholly in neither the realm of steel structures nor concrete structures.

The "Specification for Steel-to-Concrete Joints Using ASTM F1554 Grades 36, 55, and 05 Smooth Anchor Rods, ASTM A615 and A706 Grade 60 Deformed Bars, and AWS D1.1 Type B Studs" is currently being developed by the Research Council on Structural Connections and may eventually be published by the RCSC. For the design strength of the concrete anchorage, this specification refers to current American Concrete Institute ACI 318 criteria. For use in highway ancillary structures, the ACI load factors and resistance factors may be modified by the State to be consistent with AASHTO design provisions. NCHRP Report 469 also provides guidance.

### 6.5.2 Materials

Anchor rods are supplied in conformance with ASTM F1554 "Standard Specification for Anchor Bolts, Steel, 36, 55 and 105 Ksi Yield Strength." ASTM F1554 provides for three different grades of anchor rods: Grade 36 (painted blue on the projecting end), Grade 55 (painted yellow on the projecting end), and Grade 105 (painted red on the projecting end). The specified minimum yield strength ( $F_y$ ) and specified minimum tensile strength ( $F_u$ ) for each Grade are given in Table 5.

**Table 5**

**Tensile Properties for Anchor Rods**

<b>Tensile Property</b>	<b>ASTM F1554 Rod Grade 36</b>	<b>ASTM F1554 Rod Grade 55</b>	<b>ASTM F1554 Rod Grade 105</b>	<b>ASTM A706 Bars Grade 60</b>
Minimum Yield Strength $F_y$ , MPa (ksi)	248 (36)	380 (55)	720 (105)	415 (60)
Minimum tensile Strength $F_u$ , MPa (ksi)	400 (58)	516 (75)	860 (125)	550 (80)

ASTM F1554 was passed in 1994, and is essentially the same as AASHTO M314-90, although there are some differences. ASTM F1554 Grade 36 is essentially the same as ASTM A36 or ASTM A307 Grade C, and ASTM F1554 Grade 105 is equivalent to ASTM A193 Grade B7.

ASTM 1554 supercedes these specifications, and the older specifications should no longer be referenced for anchor rods. The ASTM A325 or A490 specifications should not be specified for anchor rods. The A325 and A490 bolts are intended for use in structural connections.

Since the fatigue strength of these various grades of anchor bolts is the same, it is usually not worthwhile to use the Grade 105 anchor rods. If an existing support structure (not designed for fatigue in accordance with the 2001 Specifications) has Grade 105 anchor rods that were designed for strength only, the size of the anchor rods may be much less than would be the case if Grade 55 or Grade 36 anchor rods were used. Consequently, the stress ranges in these Grade 105 anchor rods may be much greater, making them particularly likely to experience fatigue cracking. Grade 105 anchor rods should be especially evaluated to see if stress ranges calculated using the 2001 Specifications are large enough that fatigue would be expected to occur quickly. If so, an inspection of the rods using ultrasonic testing methods may be warranted.

For similar reasons, the use of anchor rods conforming to ASTM A722 with minimum tensile strength of 150 ksi should be discouraged, but may occur in some existing structures. Where such rods have been used, an inspection using ultrasonics should be performed.

Anchor rods are normally supplied in one of the following shapes:

- ◆ **Bent anchor** rods. These rods are F1554 smooth anchor rods with the embedded end bent as to form a hook (Figure 9). The anchorage to the concrete is by means of the hook. The adherence between the shank and the concrete is not reliable and should not be counted in design. Grade 105 bent rods should be avoided because they have been shown by Jirsa, et. al. to straighten before they reach any other more predictable steel or concrete mode of failure.
- ◆ **Headed anchor** rods. These rods are F1554 smooth anchor rods with a head in the embedded end (Figure 10). The anchorage to the concrete is obtained by the head. Typically, the "head" consists of one or more nuts, with either heavy washers or a plate washer. For lightly loaded anchorages, headed studs could also be utilized.
- ◆ **Deformed** bars. Concrete reinforcing bars (ASTM A 706-96, *Standard Specification for Low-Alloy Steel Deformed and Plain Bars for Concrete Reinforcement*) may be threaded and used for anchor rods. Ordinary reinforcing bars conforming to ASTM A615-96, *Standard Specification for Deformed and Plain Billet Steel Bars for Concrete Reinforcement* have been used in the past. However, because of possible low toughness, ordinary reinforcing bars should not be used for non-redundant, fatigue susceptible support structures such as cantilevers and high-mast luminaries. Reinforcing bars may rely on the deformations along the bar for anchorage to the concrete, may include an ACI standard hook, or may be threaded on the embedded end and utilize nuts and a washer for anchorage. The tensile properties of common Grade 60 reinforcing bars are also given in Table 5. The A706 specification should be used if the anchor rod is to be welded or used in seismic applications.

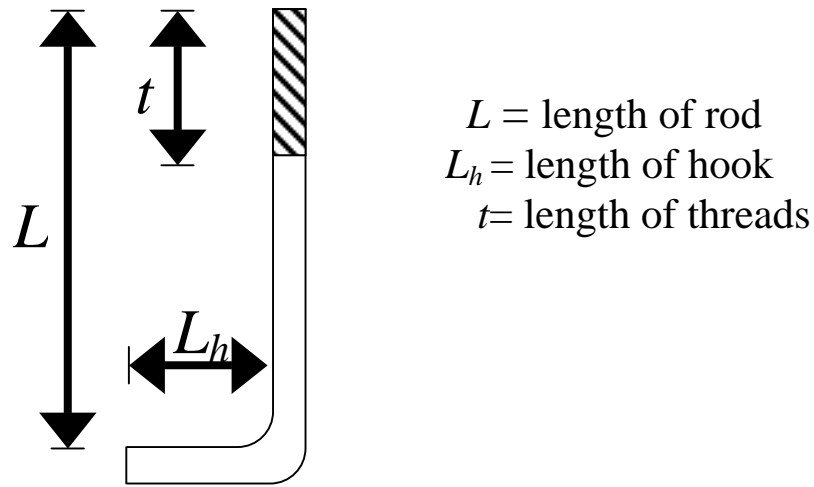

Figure 9. Bent Anchor Rod.

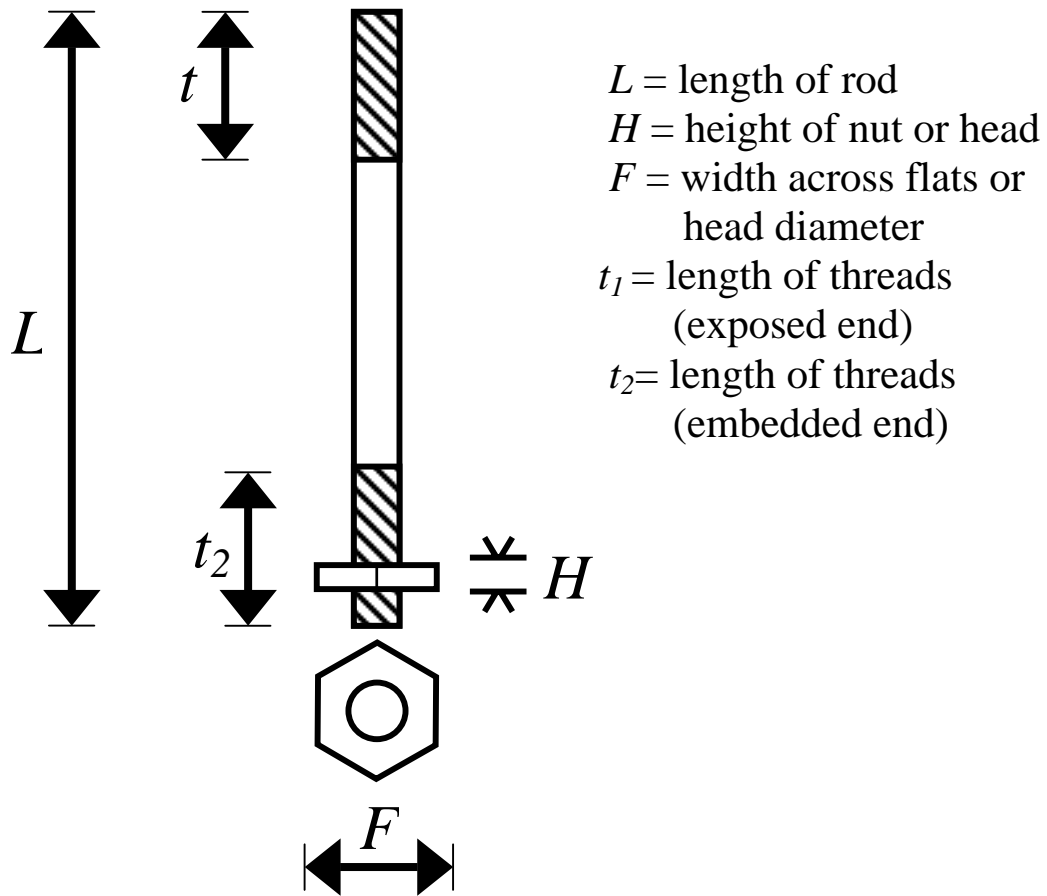

Figure 10. Headed Anchor Rod.

The use of Uniform National Coarse (UNC) threads are recommended, especially for galvanized anchor rods, although ASTM F1554 also permits the less common 8 UN series threads. The full range of diameters (1/4 to 4 inches) of anchor rods with UNC threads can theoretically sustain the overlapping of corresponding nuts (required to allow for zinc coating from

galvanizing) without stripping, while this may not be true for 8 UN threads. It should be noted however, that the Michigan Department of Transportation feels that the use of 8 UN threads is advantageous. They have not experienced any problems with thread stripping.

The thread class (tolerances) of the anchor rods should also be specified, and typically Class 2A is satisfactory. Class 2A will be provided by default if class is not specified.

Nuts on the embedded or projected end of the anchor rod should conform to ASTM A563 nuts. The recommended nut style, grade and finish are shown in Table 6. This table is based on the appendix of the ASTM A563 specification.

**Table 6**  
**Acceptable ASTM A563 Nut, Grade, Finish and Style**  
**And ASTM F436 Washer Type and Finish for Threaded Anchor Rods**

Anchor Rod	Anchor Rod Size mm (in.)*	Finish	ASTM A563 Nut Style, Grade and Finish	ASTM F436 Washer Type and Finish <sup>b</sup>
F1554 Grade 36	6-38 (1/4 - 1 1/2)	Plain (uncoated)	Hex: A, B, D, DH; plain Heavy Hex: A, B, D <sup>c</sup> , C3, D <sup>c</sup> , DH <sup>d</sup> , DH3; plain	1; plain
		Galvanized	Hex: A, B, D <sup>c</sup> , DH <sup>d</sup> ; Galvanized and lubricated Heavy Hex: A, B, C <sup>c</sup> , C3, D <sup>c</sup> , DH <sup>d</sup> , DH3; galvanized and Lubricated	1; galvanized
	Over 38-100 (1 1/2 - 4)	Plain (uncoated)	Heavy Hex: A, B, C <sup>c</sup> , C3, D <sup>c</sup> , DH <sup>d</sup> , DH3; plain	1; plain
		Galvanized	Heavy Hex: A, B, C <sup>c</sup> , C3, D <sup>c</sup> , DH <sup>d</sup> , DH3; galvanized and Lubricated	1; galvanized
F1554 Grade 55  A706 Grade 60	6-38 (1/4 - 1 1/2)	Plain (uncoated)	Hex: A, B, D <sup>c</sup> , DH <sup>d</sup> ; plain Heavy Hex: A, B, C <sup>c</sup> , C3, D <sup>c</sup> , DH <sup>d</sup> , DH3; plain	1; plain
		Galvanized	Heavy Hex: A, B, C <sup>c</sup> , C3, D <sup>c</sup> , DH <sup>d</sup> , DH3; galvanized and Lubricated	1; galvanized
	Over 38-100 (1 1/2 - 4)	Plain (uncoated)	Heavy Hex: A, B, C <sup>c</sup> , C3, D <sup>c</sup> , DH <sup>d</sup> , DH3; plain	1; plain
		Galvanized	Heavy Hex: A, B, C <sup>c</sup> , C3, D <sup>c</sup> , DH <sup>d</sup> , DH3; galvanized and Lubricated	1; galvanized
F1554 Grade 105	6-38 (1/4 - 1 1/2)	Plain (uncoated)	Hex: D <sup>c</sup> , DH <sup>d</sup> ; plain Heavy Hex: C <sup>c</sup> , C3, D <sup>c</sup> , DH <sup>d</sup> , DH3; plain	1; plain
		Galvanized	Heavy Hex: DH <sup>d</sup> , DH3; galvanized and lubricated	1; galvanized
	Over 38-100 1 1/2 - 4	Plain (uncoated)	Heavy Hex: DH <sup>d</sup> , DH3; plain	1; plain
		Galvanized	Heavy Hex: DH <sup>d</sup> , DH3; galvanized and lubricated	1; galvanized

<sup>a</sup> Applicable only to F1554 Grade 55 anchor rods.  
<sup>b</sup> Applicable only if washer is required.  
<sup>c</sup> ASTM A194 nuts Grade 2 or 2H are acceptable equivalents for Grades C and D nuts.  
<sup>d</sup> ASTM A194 nuts Grade 2H are acceptable equivalents for Grades DH nuts.

\*Note: Metric bolt sizes and threads are different, for soft conversion 1 inch = 25 mm

Corrosion protection is particularly important for fatigue critical anchor rods, since corrosion pitting can degrade the fatigue resistance. Anchor rods, nuts, and washers that are used outdoors are typically galvanized. ASTM F1554 permits hot dip galvanizing by ASTM A153 Class C or mechanically deposited by ASTM B695, Class 50. The purchaser should specify which of these processes should be used or state "no preference." The hot dip process provides a heavier zinc coating and longer life. Galvanized deformed bars may be used and should be specified by referencing ASTM A767. Galvanized anchor rods should always be shipped with the nuts pre-assembled to the anchor rods to ensure good fit and ability to run the nut down the threads easily. This should be specified in the purchase order because it is not required in the ASTM specifications.

There are two types of washers for anchor rods: standard washers and plate washers. Standard washers are ASTM F436 washers. When "Normal Holes" are used, plate washers at least 5/16 inch thick should be used. Plate washers should be structural grade steel and be galvanized to match the anchor rods. Beveled standard washers should be used when the outer face of the base plate has a slope that is greater than 1:20 with respect to a plane that is normal to the anchor axis. If an anchor bolt is incorrectly installed resulting in larger out-of-plumbness, specially fabricated washers may be needed to allow proper bearing of the connected parts.

## **6.6 Base Plate and Holes**

Research described in *NCHRP Report 412* has shown that the base plate should be at least as thick as the anchor rod diameter to provide for even distribution of the load and to minimize prying forces. The minimum distance from the center of the anchor rod hole to the edge of the base plate should be two times the nominal diameter of the anchor rod.

Base plates are normally supplied shop welded to the posts or pole. The most common pole to base plate connection is a weld socket joint, where the central portion of the base plate is cut out so the pole can slip into the opening. As a result, particularly for large diameter poles such as high mast lights, the base plate is in reality a base ring with a resulting decrease in plate bending stiffness. Field inspectors have reported observing the base plates actually flex between anchor rods for high mast lights due to normal wind loads. This tendency can be reduced by use of a larger number of anchor rods or a thicker base plate.

Holes may be thermally cut in the base plates. In most cases, the anchor rod holes in the base plate should be "Shear Holes" with the dimensions shown in Table 7, as recommended in *NCHRP Report 469*. Research by Cook has shown that this size of hole is adequate for a correct transfer of shear forces from the base plate to the anchor rods and to allow plastic redistribution of shear forces. On the other hand, if anchor rods are not required to transfer shear, only holes labeled as "Normal Holes" in Table 7 are needed. These normal holes are the same holes recommended in the *AISC Manual of Steel Construction* for base plates. They are oversized to allow for an easy placement of the base plate during erection.

**Table 7**

**Nominal Anchor Rod Hole Dimensions**

Anchor Rod Diameter In.*	Nominal Anchor Rod Hole Dimensions <sup>a, b</sup> , in.*	
	Shear Holes (diameter)	Normal Holes (diameter)
1/2	5/8	1 1/16
5/8	13/16	1 3/16
3/4	15/16	1 5/16
7/8	1 1/16	1 9/16
1	1 1/4	1 13/16
1 1/4	1 9/16	2 1/16
1 1/2	1 13/16	2 5/16
1 3/4	2 1/16	2 3/4
≥2	$d_b + 5/16$	$d_b + 1 1/4$

<sup>a</sup> The upper tolerance on the tabulated nominal dimensions shall not exceed 1/16-in.  
<sup>b</sup> The slightly conical hole that naturally results from punching operations with properly matched punches and dies is acceptable.

\* Note: Metric bolt sizes and threads are different, for soft conversion 1 inch = 25 mm

### 6.7 Anchor Rod Joints

There are several types of joints for the base plate to foundation connection. These have evolved within particular industries, with the so called threaded-shear-and-uplift joint and double-nut-moment joint used for nearly all ancillary structures. These are cost effective and provide good performance when properly designed and installed.

The threaded-shear-and-uplift joint rests directly on the concrete or on a grout pad (Figure 11). The base plate is held down by nuts atop the base plate. Single nuts are most common, but double nuts are sometimes used. For proper joint performance, the base plate must be in direct contact with the grout and not be supported by leveling nuts or shim packs. One technique to achieve full grout support is to set the base on shim packs to proper elevation, grout the base and then remove the shims and grout the resulting voids. Only then can the anchor rods be fully pretensioned. Use of proprietary prepackaged grout mixes, so called “non-shrink grout” is recommended and should be carefully installed to manufacturers’ recommendations. The threaded-shear-and-uplift joints can develop some resistance to bending moment as a couple between compressive bearing force on the grout and tensile forces in the anchor rods. It may be difficult to retain the pretension in the anchor rods under cyclic loads as the base plate wears the grout. For these reasons, this type of joint is not recommended by NCHRP Report 469 for large cantilevered support structures, although it is still commonly used for many luminaries and small traffic signal supports. This type of joint is suitable for bridge support structures where there are multiple posts.

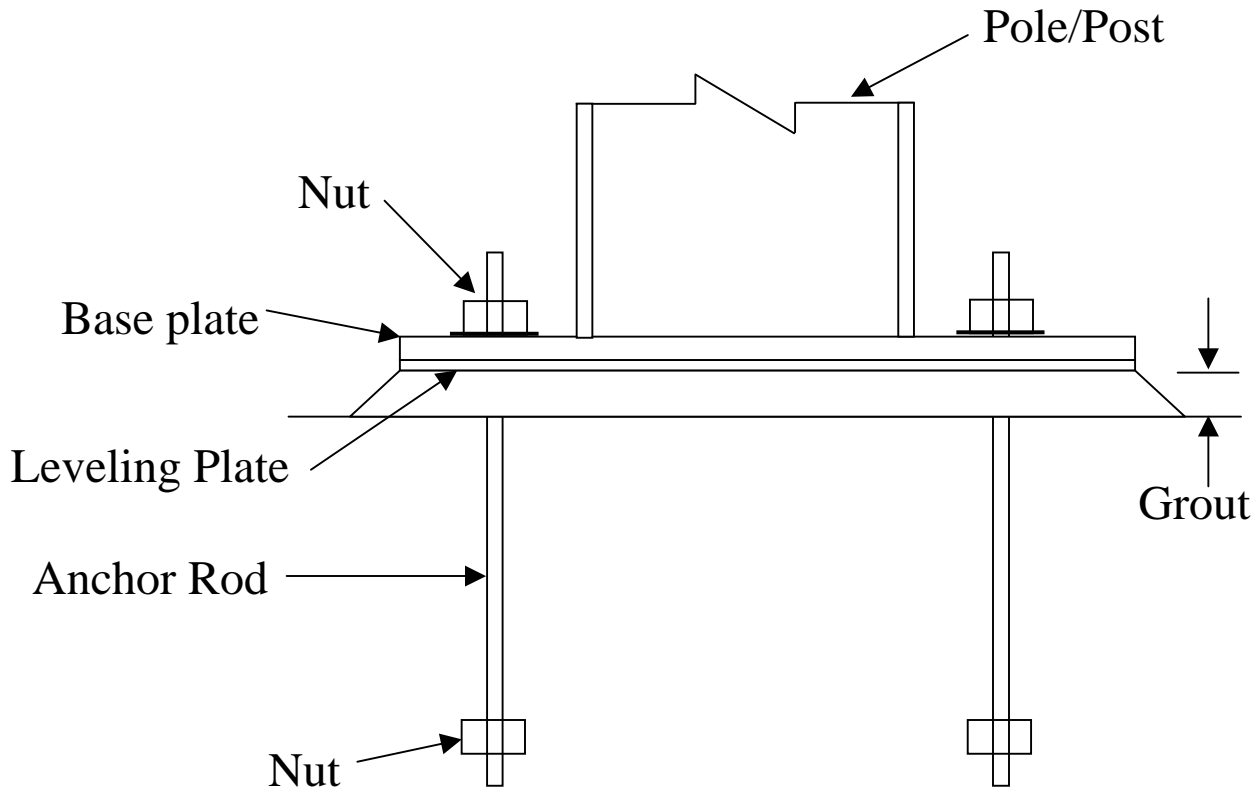

**Figure 11. Threaded-Shear-and-Uplift Joint.**

All three shapes of anchor rods will perform correctly in this type of joint. The anchor rods transmit shear and tension, while compression forces are transmitted directly by bearing of the base plate on the concrete and are not carried by the anchor rods. As a result of the compression on the concrete, friction will be developed between the base plate and the concrete. Shear friction strength should be calculated using the factored load combination that gives minimum possible compression from dead load along with the maximum uplift that is consistent with the lateral load that is being evaluated. The effect of live load should not be included when calculating the shear friction strength unless the live load causes the lateral load or uplift.

If the friction strength, is greater than the factored applied shear or torsion on the joint, anchor rods are not needed for transmitting shear or torsion. In fact, if the friction is sufficient to handle the shear, and if there is no uplift, then anchor rods are, in theory, not needed at all for service loads. In this case, anchor rods must be provided for stability during erection but need not be designed for the service loads. If the anchor rods are designed only for the factored loads during erection, NCHRP Report 469 recommends including a minimum lateral shear load equal to 5.0 percent of the axial load from dead load during erection. The anchor rods must also resist a minimum moment to account for an ironworker on the pole as required by OSHA.

If, on the other hand, the factored loads exceed the friction capacity of the joint, anchor rods should be assumed to transmit the entire shear because the friction may no longer be effective at the deformation levels required to develop the shear strength of the anchor rods. The shear

strength of the anchor rods may be taken as the smaller of the sum of the steel shear strengths of the contributing individual anchor rods or the concrete shear strength of the anchor group.

Whenever anchor rods are needed for transmitting shear in this type of joint, the base plate should have shear holes. Also, in the same case, bearing of the anchor rod on the walls of the shear holes should be checked. As an option, normal holes can be provided in the base plate and plate washers having shear holes can be placed over the anchor rods and field welded to the base plate after the base is set. The plate washers and welds must be designed to transmit all calculated shear forces and welding must conform to applicable portions of the AWS Bridge Welding Code.

In double-nut-moment joints, the base plate stands off from the concrete foundation and bears on leveling nuts (Figure 12). Thus, the base plate is attached to anchor rods through double nuts: the leveling nut and a top nut (or nuts). This type of joint may be suitable for any type of support structure and is required for cantilevered support structures designed by the 2001 Specifications. Washers should be used under both nuts, and beveled washers should be used if the misalignment exceeds 1:40 for the double-nut-moment joints. Double-nut-moment joints are easy to level and plumb and are also very reliable for transmitting moment to the foundation; therefore, they are satisfactory for non-redundant structures and seismic or fatigue-loaded structures such as highway sign, signal, and light supports.

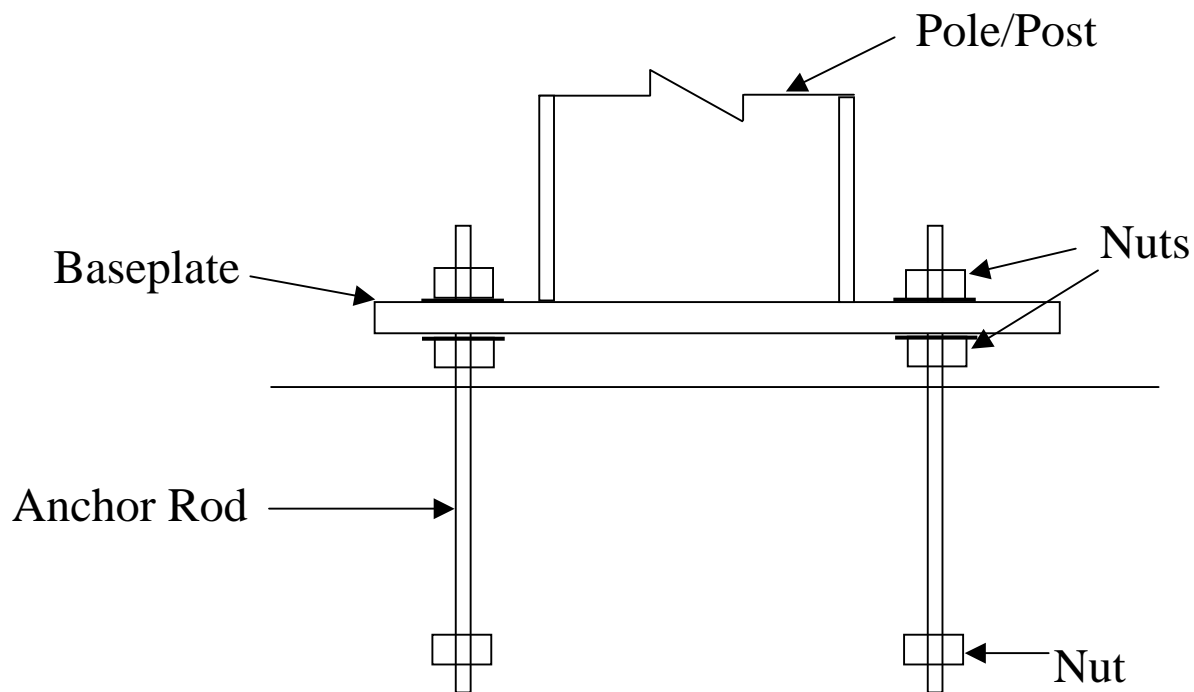

**Figure 12. Double-Nut-Moment Joint.**

Double-nut joints are pretensioned between the nuts only, and the pretension has no effect on strength. Research reported in NCHRP Report 412 has shown that the pretension gives slightly better fatigue resistance, but the effect is not that significant. The anchor rod below the leveling nut is not pretensioned but will still see the full cycle of fatigue loads. More importantly, the



pretension ensures that there is a good load distribution among the various anchor rods. Therefore, there are special tightening procedures for these joints.

Headed rods and deformed bars are best suited for double-nut-moment joints. In double-nut-moment joints, anchor rods are designed to resist all the axial forces, moments, and shears applied to the joint, even if there is grout under the base plate.

Opinions on whether or not grout should be used with double-nut-moment joints differ. As noted above, in a properly designed joint, all loads are resisted in the anchor rods. Due to the greater stiffness of the anchor rods compared to the grout, and the tendency of the grout, even for so-called “non-shrink grouts”, to shrink, though perhaps imperceptibly, below the bottom of the base plate, little load transfer to the grout is likely even if assumed so in design. Grout, if well installed, may pick up loads due to very high or unexpected load cases. Proper grout installation is difficult when base plates tend to be rings, as with large light poles. A means must be provided to restrict grout flow inside the base ring while fully filling beneath it. For these reasons, and several listed below, grouting of double-nut-moment joints is generally not recommended:

- ◆ It may crack, retain moisture, and then promote corrosion.
- ◆ It makes it impossible to inspect and retighten bottom nuts if necessary.
- ◆ In order to place the grout after the base plate is in place, the standoff distance between the top of concrete and the bottom of the leveling nut may exceed the recommended distance equal to the anchor rod diameter.

Where base plates are not grouted, a stainless steel wire mesh should be placed around the base plate to eliminate debris from accumulating beneath the base plate and keep animals out and protect electrical wires if present.

There is an unfortunate trend toward using fewer very large anchor rods. It is always better to use more, smaller anchor rods than fewer, bigger anchor rods. Especially if the failure mode is fatigue and the structure is non-redundant, it is essential to have at least eight anchor rods in the anchor rod group. In the event of one anchor rod failure from fatigue, the increase in the load on the neighboring anchor rods is tolerable for the case of an eight-bolt group, and there will be weeks or months typically before a second anchor rod fails and total collapse occurs. This gives the joint some measure of redundancy, even if the structure is non-redundant. The fatigue failure of one anchor rod from a six-or four-bolt group, however, may lead to immediate collapse.

If the embedded head of an ASTM F1554 anchor rod is a nut or is fastened with nuts, the head nut or the nuts fastening the head should be prevented from rotating while the anchor rod is tightened. Two methods have been shown to prevent rotation:

- ◆ Tack weld the nut to the anchor rod on the unstressed (bottom) side of the nut if the ASTM F1554 rod is a grade 36 rod or a grade 55 rod.
- ◆ Jam another nut on the head nut for any grade of ASTM F1554 rod.

Neither the tack weld nor the jam nut will affect the ultimate or fatigue strength of the rod.

## 6.8 Installation of Anchor Rods

Proper installation of the anchor rods is the responsibility of the foundation contractor, and inspection and testing is to be performed by the foundation contractor. Records should be kept of the dates and results of testing and inspection, and these records should be available for the Engineer of Record or their representative to review. The Engineer of Record may require that their representative witness the inspection and testing.

Prior to placing the anchor rods in the concrete, an anchor rod rotation capacity test should be run with at least one anchor rod from every lot. This test may be run in a Skidmore-Wilhelm device or in a mockup of the base plate using a small piece of plate with one hole of equivalent grade, thickness, and finish. The test consists of Steps 2 through 14 of the tightening procedure (presented later), adapted as necessary because there is no post or crane, and there is only one anchor rod. NCHRP Report 469 recommends that the nut be rotated at least to the required rotation given in Table 8. After the test, the nuts should be removed and inspected for damage to their threads.

Then the anchor rod is removed from the test plate and restrained while the nuts are turned onto the bolts well past the location of the leveling nut and top nut in the test and backed off by one worker using an ordinary wrench (without a cheater bar). The threads are considered damaged if more than minimal effort is required to turn the nut. If there is no damage to the anchor rod or nut during this test, they may be used in the foundation. If there is damage to the threads or an inability to attain at least the verification torque, the lot of anchor rods should be rejected.

Though this testing may not be practical on small projects, it is recommended where economically justifiable on larger projects.

**TABLE 8**

### Nut Rotation for Turn-Of-Nut Pretensioning

Anchor Rod Diameter, in*.	Nut Rotation from Snug-Tight Condition a, b, c	
	F1554 Grade 36	F1554 Grades 55 and 105 A615 and A706 Grade 60
<1 1/2	1/6 Turn	1/3 Turn
>1 1/2	1/12 Turn	1/6 Turn

a. Nut rotation is relative to anchor rod. The tolerance is plus 20 degrees.  
b. Applicable only to double-nut-moment joints.  
c. Beveled washer should be used if: a) the nut is not in firm contact with the base plate; or b) the outer face of the base plate is sloped more than 1:40.

The recommended procedure for installing anchor rods in the foundation is as follows:

1. Anchor rods should be installed as a group and should be secured against relative movement and misalignment, such as with a template set composed of rings with nuts on both sides at two locations along the length of the anchor rods. One of the plates or rings is usually above the top of concrete and is reused as a template, see Figures 13 and 14.

2. The template set (or other device) with anchor rods should be secured in its correct position in accordance with the drawings.
3. The concrete should be placed and cured.



**Figure 13. Four Anchor Rod Group in a Template.  
Note Top is Galvanized.**



**Figure 14. Template Secured to the Forms to Ensure Proper Alignment.  
Note Anchor Rod Threads Taped to Prevent Contamination by Concrete.**

4. If a top template is above the concrete surface, it may be removed 24 hours after placing the concrete.
5. The exposed part of the anchor rods should be cleaned with a wire brush or equivalent and lubricated with beeswax or toilet-ring wax.

6. After at least 24 hours, the anchor rods should be inspected visually to verify that there is no visible damage to the threads and that their position, elevation, and projected length is within the tolerances of the *AISC Code of Standard Practice for Steel Buildings and Bridges*; and that the misalignment from vertical is no more than 1:40. It is good practice to use a steel or wood template with the hole pattern to check the base of the post and the anchor rods. The nuts should be turned onto the rods well past the elevation of the bottom of the leveling nut and backed off by one worker using an ordinary wrench without a cheater bar.
7. Once the concrete has reached sufficient strength, anchor rods are ready to be subjected to erection loads.

## 6.9 Procedure for Anchor Rod Tightening and Follow-Up Retightening

Anchor rod joints require some level of pretensioning. Only installation of double-nut-moment joints is covered in this section since single-nut joints are generally not recommended for large cantilevered structures. Requirements for fatigue-loaded, threaded-shear-and-uplift joints may be derived from the installation requirements of double-nut-moment joints.

The "turn-of-the-nut" method is primarily relied upon to achieve a certain pretension between the double nuts of the anchor rods. Although torque is a poor way to install bolts and anchor rods, it is the only alternative for defining snug-tight conditions, inspection, and retightening. Lubrication of the threads of the anchor rod, the threads of the nut, and the bearing surface of the nut is required for proper installation. Beeswax and toilet-ring wax have been shown to provide good lubrication. In this document, the snug-tight condition for anchor rods is defined as nuts tightened to a torque between 20 and 30 percent of the verification torque computed using the following equation:

$$T_v = 0.12d_bF_t$$

Where

$T_v$  = verification torque (inch-kips or kN-mm)

$d_b$  = nominal body diameter of the anchor rod (inches or mm)

$F_t$  = installation pretension (kips or kN) equal to 50 percent of the specified minimum tensile strength of F1554 Grade 36 rods, and 60 percent for the rest of threaded fasteners.

Research by Till and Lefke has shown that a value of 0.12 in this relationship is adequate for common sizes and coatings of anchor rods. (Note: the torque in "in-kips" can be multiplied by 83.3 to get ft-lb and the torque in kN-mm can be multiplied by 0.73 to get ft-lb).

Very large torque may be required to properly tighten anchor rods greater than 24 mm (1 inch) in diameter. A "cheater bar" such as a pipe or extension handle as much as 3 meters (10 feet) long may be required for the torque wrench. For snugging the leveling nuts, an open-end wrench with a 3 meter (10 feet) long pipe or extension handle will typically suffice. Tightening the top nuts for anchor rods greater than 1 inch in diameter may require either of the following:

- ◆ A hydraulic torque wrench (Figure 15) or
- ◆ A box end "slug" or "knocker" wrench with a 3 meter (10-ft), long pipe or extension handle.



**Figure 15. A Hydraulic Torque Wrench Tightening Anchor Rod Nuts to Achieve Needed Rotation.**

The box end wrench may be moved by impact with a sledgehammer or by the efforts of several workers. Inadequately tightened bolts can lead to fatigue failures and further loosening of the nuts under cyclic loading. A less likely outcome of failure to follow the tightening procedure is over-tightened rods and associated plastic deformation and stripping of the threads, which may require removal and replacement.

The following steps provide a recommended anchor bolt installation and tightening procedure:

1. The proper position of the anchor rods and the proper hole pattern on the post are verified (preferably with a template).
2. It should be verified that the nuts can be turned onto the rods well past the elevation of the bottom of the leveling nut and backed off by one worker using an ordinary wrench without a cheater bar.
3. If threads of anchor rods were lubricated more than 24 hours before placing the leveling nut or have been wet since they were lubricated, the exposed threads of the anchor rod should be relubricated. Leveling nuts should be cleaned, threads and bearing surfaces lubricated.
4. The leveling nuts are placed on the anchor rods and made level.
5. Leveling nut washers should be placed.
6. Next, the post or end frame is brought in and positioned with a crane.

7. The post or end frame is plumbed or the base plate leveled (as shown on the erection drawings) and the anchor rods are tightened. The following is the installation sequence for double-nut-moment joints using the "turn-of-the-nut" method of pretensioning.
8. Top nut washers should be placed.
9. Threads and bearing surfaces of the top nuts should be lubricated, placed, and tightened to the snug-tight condition in a star pattern.
10. Leveling nuts should be tightened to the snug-tight condition in a star pattern.
11. At this point, the installation crew should verify if beveled washers are necessary. Beveled washers may be necessary under the leveling or top nut if any face of the base plate has a slope greater than 1:20 and/or any nut could not be brought into firm contact with the base plate. If any beveled washer is required, the installation crew should disassemble the joint as necessary, add the beveled washer(s) and retighten (in a star pattern) to the snug condition top and leveling nuts.
12. Before turning, the reference position of the top nut in the snug-tight condition should be marked with a suitable marking on one flat with a corresponding reference mark on the base plate at each bolt. Top nuts should be turned in increments in a star pattern (at least two full tightening cycles) to the nut rotation specified in Table 8. After tightening, the nut rotation should be verified.
13. The load may be released from the crane.
14. A torque wrench should be used to verify that a torque at least equal to the computed verification torque,  $T_v$ , is required to additionally tighten the leveling nuts and the top nuts. An inability to achieve this torque should be interpreted to indicate that the threads have stripped and should be reported to the Engineer of Record.
15. After at least 48 hours, the torque wrench should be used to verify that a torque at least equal to 110 percent of the verification torque,  $T_v$ , is required to additionally tighten the leveling nuts and the top nuts on the anchor rods. An inability to achieve this torque shall be interpreted to indicate that the threads have stripped and should be reported to the Engineer of Record.
16. The nuts on the anchor rods should be prevented from loosening unless a maintenance plan is in place to verify at least every 4 years that a torque equal to at least 110 percent of the verification torque,  $T_v$ , is required to additionally tighten the leveling nuts and the top nuts. Jam nuts or other locking devices may be used to prevent nut loosening.

Tack welding the nut to the anchor rod on the unstressed (top) side of the top nut has been used successfully to prevent loosening or to prevent theft of the nuts, although this would not be allowed under AWS D1.1 and therefore cannot be recommended. If it is used, only ASTM F1554 Grade 36 or Grade 55 rod, or Grade A 706 reinforcing bar should be tack welded. Under

no circumstance should any nut be tack welded to the washer or the base plate nor should the leveling nut be tack welded.

## 7.0 MANAGEMENT OF INVENTORY

Collection of inventory information and the ability to organize and categorize the inventory is paramount for an ancillary structure inspection program. This section details collection of such information and development of a useful database.

### 7.1 Collection of Inventory Information

One of the biggest problems in inspection of ancillary structures is the lack of information. Rarely are the structures numbered for easy identification. Historical records such as as-built plans, maintenance repairs, and installation of new sign panels are hard to find. Only now are many states beginning to assign structures numbers during design and/or fabrication similar to bridge structures. Such records are very important due to the many changes to the design specifications of sign structures over the years. Another problem is that fabricators have substituted design drawings with their own shop drawings. While this is an acceptable practice, it adds another layer of documentation that is many times lost.

For these reasons the initial collection of inventory information on ancillary structures is critical. Key pieces of information include route, milepost, GPS coordinates, route association (if not on mainline), county, town, etc. Photos and sign measurements are important to help identify structures, as seen in Figure 16. The following section on database development gives a complete listing that has been used in New Jersey for inventory purposes.

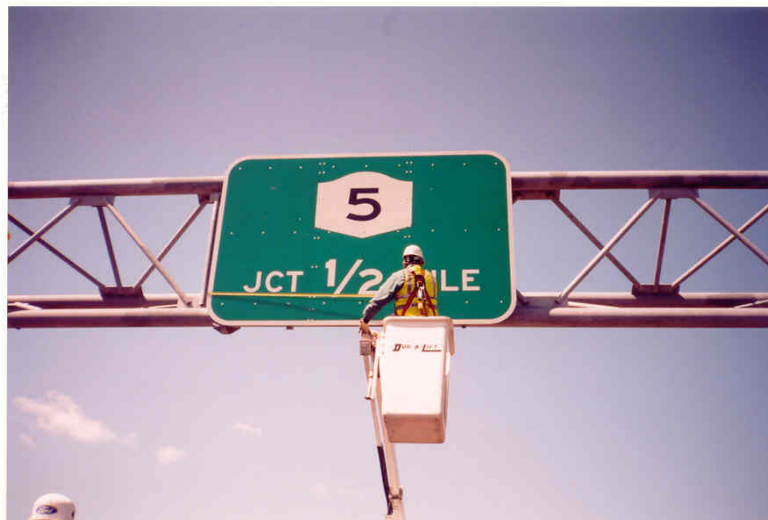

**Figure 16. Inspector Measures Sign Panel During Inventory/Inspection Operation.**

### 7.2 Database Development

The large amount of data collected to properly inventory a sign structure warrants a sophisticated database that can sort and prioritize according to structure type, age, location, material, ratings and repair priorities. The goal is to have a database useful to the field inspector, program manager, and maintenance and repair personnel. Each can then draw on

their desired information. The database can be a simple spreadsheet but usually involves a more sophisticated program like Microsoft Access or Oracle.

### 7.3 Example Inventory Checklist

The checklist below is referenced from the New Jersey Department of Transportation Overhead Sign Database Program. These are items deemed important to that particular agency, and will of course vary somewhat with individual State needs. Many items involve the physical location of the structure, the personnel involved with the inventory/inspection, specifics about the structure itself, important dimensions and attachments.

- NJDOT Required Inventory / Inspection Information
  - Date Inspected
  - Previous Inspection Date
  - Inspection Type
  - Cycle Number
  - Recommended Inspection Frequency
  - County Code
  - Municipality Code
  - Latitude/Longitude
  - Route
  - Milepost
  - Location Description
  - Traffic Control Requirements
  - Contract Number
  - Consultant Firm Name
  - Consultant Project Manager
  - Consultant Team Leader
  - Confirming Registered PE
  - Structure Name
  - Structure Configuration
  - Number of Truss Sections
  - Material Type
  - In Service Status and Date
  - Overall Span Length
  - Minimum Vertical Clearance
  - Left and Right Lateral Clearance
  - Number of Traveled Lanes
  - Number of Signs
  - Area of each Sign
  - Installation Year
  - Plans Available?
  - Walkway?
  - Lighting?
  - Modification since construction
  - Damage Reports
  - Element Ratings
  - Element Repairs



## **7.4 Inventory Numbering**

An inventory-numbering scheme is required for all ancillary structures. The inventory number is usually the key piece of data that any database relates to. It can be sequential along a route, and contain information relevant to location such as County and Town Coding. It is highly recommended that after an ancillary structure number is assigned the number be immediately stenciled onto the existing sign. Documentation should flow from the field to the sign designer so that any new structures would not be assigned that specific inventory number.

One problem with sign stenciling is that many structural supports are on shoulders that are targets for roadway grime, salt spray and snowplows. Proper positioning of the sign number should consider these effects. The stencil can be placed above the spray of salt or on the backside of the structure. Another option might be to stencil the sign bridge instead of the supporting tower members, or to stamp the number in with metal stamps.

## **8.0 INSPECTION VARIABLES**

### **8.1 Types of Inspections**

There are several inspection types depending on the circumstances of the sign structure. These inspection types follow those typically performed for bridge inspections.

#### **8.1.1 Initial Inspection**

This inspection should take place shortly after the sign structure is constructed. It is common for bolts on sign structures, shortly after installation, to become loose and should be rechecked within 60 days after construction is complete.

#### **8.1.2 Routine**

This can simply consist of a ground level inspection with no attempt to close traffic lanes. This type of inspection is recommended during the first phases of a sign structure inspection program to obtain inventory information and quickly look for deficiencies. However, since many structural deficiencies such as weld cracks in the overhead truss cannot be identified from a ground level inspection, this type of inspection is not recommended to occur normally in subsequent inspection cycles. However, as stated in the 'Traffic Control' portion of these guidelines cyclic ground level inspections may supplement an In-Depth inspection due to severe traffic restrictions.

#### **8.1.3 In-Depth**

This type of inspection is recommended as a typical inspection of a sign structure. The inspection will be 'Hands-On' as discussed in the following section.

#### **8.1.4 Interim Inspection**

This would be recommended by the Inspector if a sign structure is found to have deficiencies or other problems that require more frequent inspection than the typical inspection frequency. An Interim Inspection might also be required after temporary repairs are made to the sign structure. For example, some measures are immediately taken when cracks are found in the overhead

sign truss. This may be simply removing the sign panels to reduce wind load, installation of a dampener, or actually completing repairs such as the use of fiber composite material to temporarily restrain the cracked connection.

### **8.1.5 Damage Inspection**

This inspection is provided after a sign is damaged. This could include traffic impact on the post, an over height hit of the truss or sign panels, etc.

## **9.0 INSPECTION FREQUENCY**

Determining the frequency for ancillary structure inspection is dependent on several factors. One is material type. For example, aluminum truss type span structures have shown increased problems due to fatigue deficiencies. High strength anchor rods have been more problematic than mild steel. Frequency can also be based on structural redundancy. Cantilever sign structure supports only have one main support instead of two or more with span type structures. Sign structures associated with another structure such as a bridge-mounted sign may be inspected as the bridge is inspected during a normal two-year frequency. Many owners are initiating sign structure programs and determining frequency after the first cycle is complete and deficiencies can be categorized. Another previously discussed factor is traffic control and the problems associated with access.

Some guidelines for inspection frequencies are as follows:

**Material Issues:** Since it has been determined that aluminum sign bridges are problematic, it is recommended that a two-year frequency of in-depth inspections be conducted. To determine if material issues are relevant prior to a full-scale inspection program is set in motion a sample project that inspects 10% of the structure inventory may be prudent.

**Redundancy Issues:** For cantilever and other non-redundant structures a four-year frequency is recommended.

**Typical Sign Bridges:** A typical two tower, two or four post sign bridge with a steel superstructure need only be inspected hands-on every six years. Routine or ground inspections can be conducted more frequently to check corrosion of posts or connection problems.

**Traffic Issues:** If 'severe' restrictions exist, as discussed in the 'Traffic Control' section of these guidelines, frequencies stated above can be extended but supplemented by routine ground inspections.

## **10.0 INSPECTION PRIORITIES AND PLANNING**

The ancillary structure inspection process should not proceed until a structure inventory has been completed. Only then can proper planning take place. Many State Departments of Transportation have started their structure inspection program using the following strategy:

1. Perform field reconnaissance and collect inventory information
2. Perform a random sampling inspection project of perhaps 10% of total inventory

3. Based on findings of sample project, prioritize and continue full inspection program.

#### Example Priorities

- Aluminum sign bridges
- Sign Bridges with long span
- Non Redundant cantilever sign structures
- Sign Structures greater than 20 years old
- Sign Structures where sign panel sizes exceeds those originally designed for.

## **11.0 REQUIRED RESOURCES**

### **11.1 Suggested Personnel Requirements**

Inspection of ancillary structures is not required by Federal Regulations, nor are there any requirements for those person who conduct such inspections.

Inspection of ancillary structures has similarities to highway bridges but also some special circumstances that should be addressed. The qualifications for bridge inspection personnel as given in the National Bridge Inspection Standards (23 CFR 650), are summarized below with suggested special modifications for ancillary structures.

Program Manager – The program manager is in charge of the scoping, scheduling, cost control, and quality assurance. Minimum qualifications should be a Professional Engineer or have a minimum of 10 years of experience in structures inspections in a responsible capacity and have completed comprehensive training based on the Guidelines for the Installation, Inspection, Maintenance and Repair of Structural Supports for Highway Signs, Luminaries and Traffic Signals.

Team Leader – Have qualifications specified for Program Manager or have a minimum of 5 years of experience in structure assignments in a responsible capacity or NICET Level III or IV certification in Structure Inspection and have completed a comprehensive training program based on the Guidelines for the Installation, Inspection, Maintenance and Repair of Structural Supports for Highway Signs, Luminaries and Traffic Signals. In addition, the Team Leader should be trained in work zone traffic control such as the NHI Course 38003 – Design and Operation of Work Zone Traffic Control.

An inspection team will usually consist of a Team Leader and an Assistant. Assistant Team Leader qualifications can be project specific. Due to the extent of welded members found in most ancillary structures, it is desirable for at least one team member to have experience in visual weld inspection as well as training in locating and recognizing fatigue cracking.

All inspection personnel should be able to physically perform the work. Although bucket trucks are typically used to access the sign bridge, an adequate in-depth inspection cannot be fully performed from the bucket and some climbing will be required.

## 11.2 Tools and Equipment

Each inspection team should be fully equipped to perform the structural inspections. Additional equipment may be needed since sign structure inspectors routinely make minor repairs. The reason minor repairs may be attempted during the inspection process is to avoid another work zone setup to perform a minor repair. Such minor repairs may include bolt tightening, replacement of fasteners such as cotter pins, and paint touchup, along with replacing missing pole caps, anchor rod nut covers and hand hole covers.

The list below is what would be considered as 'Tools of the Trade' for the sign structure inspector.

- ◆ Work-Zone protection and traffic control equipment, including signs, traffic cones and flags (in compliance with the MUTCD and local requirements).
- ◆ Personal safety equipment, including hard hats, reflective high-visibility vests, goggles, face shields, harnesses (or belts), and lanyards. (All OSHA approved).
- ◆ Basic access equipment, such as a step ladder, extension ladder, and rope
- ◆ Tools for inspection, including chipping hammers, pocket knives, screwdrivers or awls, magnifying glass, magnet, flashlights, mirrors. The hammer is an excellent tool for testing anchor rods. The mirror is for inspecting circumferential welds while climbing the truss. A magnet can confirm whether the material is steel or aluminum, as aluminum is nonmagnetic.
- ◆ Tools for measuring, such as a plumb bob, levels, folding rulers, tapes, calipers, thickness gauges
- ◆ Wrenches, allen wrenches, screwdrivers for removing access panels and bolt covers
- ◆ Torque wrench for bolt tightening or checking bolt tension
- ◆ Digital camera for documentation
- ◆ Shovel and brush cutters
- ◆ Marking utensils such as lumber crayons or keel, paint sticks, soapstone, center punch
- ◆ GPS-recommended since many signs look similar, even sign panels, and are routinely replaced without complete notification to all parties.
- ◆ Electronic device for measuring vertical clearances is recommended.
- ◆ Equipment to number the signs, either paint stenciling, adhesive tape, paint markers, etc.
- ◆ Non-Destructive test equipment such as ultrasonic testing, dye penetrant, or magnetic particle.
- ◆ Remote cameras for high mast lighting
- ◆ Bucket truck, see explanation below

While free climbing from the shoulder or with ladders, Figure 17, can access many sign structures, the most typical way the sign structure is accessed is by use of a vehicle mounted access bucket, Figure 18. These vehicles are commonly used by cable and telephone companies and are readily available for rent. For most ancillary structures a 30' boom is sufficient. Access vehicles must be operated in accordance with required safety procedures.



**Figure 17. Inspector Climbing Structure.**



**Figure 18. Bucket Truck-Most Common Way to Access Sign Structure.**

### **11.3 Traffic Control**

One of the most difficult challenges for the inspection and evaluation of overhead sign structures is that of access for inspection personnel. This challenge arises from the need to satisfy Maintenance and Protection of Traffic (MOT) safety requirements while controlling costs within acceptable limits. Such access strategies include night work, mobile lane closures, and other innovative methods for short-term lane closures. At the heart of the ability to gain inspection access is determination of what areas of these structures are most critical and how often should they be inspected.

It is suggested that a cost benefit ratio be developed for each overhead sign inspection project that considers inspection access, inspection detail, MOT cost and overall safety. Some suggestions for each are presented below with the key determining factor defined as the lane closure restrictions. All suggestions comply with the basic requirements discussed in the 'Manual for Uniform Traffic Control Devices' (MUTCD).

It is recommended that night work be a last resort in planning an inspection program. The small fatigue cracks in a typical sign truss are difficult enough to spot during daytime inspection hours. If inspections are performed at night, adequate lighting must be provided. Below are several considerations in developing a sign inspection strategy driven by closure restrictions.

### **Minimal Lane Closure Restrictions**

An example of minimal restrictions would be the allowance of double lane closures during normal work hours between 8 AM and 5 PM. For this scenario it is suggested that conventional stationary type MOT be used. The closure, since of a temporary nature, should be easily deployed and removed. Typical MOT equipment would be a fabric sign conforming to NCHRP 350. Fabric signs allow easy deployment over rigid metal. Also, cones should be used over barrels or barricades again to allow easy setup and removal. If more substantial MOT equipment is required means other than a stationary setup should be investigated. Under these lane closure restrictions a complete full hands on inspection should be scheduled as recommended in the 'Inspection Frequency' section of this document.

### **Moderate Lane Closure Restrictions**

An example of a moderate closure restriction would be limited closure time such as a 10 AM to 2 PM window for a double lane closure. A conventional stationary closure could be considered if a full 8-hour window can be scheduled using single lane closures during the morning and afternoon hours. An efficient inspection day might allow for a morning single lane closure encompassing several sign structures that can be expanded into a double lane closure at 10 AM. It is recommended that under moderate lane closure restrictions a full hands on inspection could be completed per the frequency recommended in the 'Inspection Frequency' section of this document.

### **Severe Lane Closure Restrictions**

An example of a severe lane closure restriction would be no daytime double lane closures allowed. In this case, the best option would be a mobile night time closure. To reduce the risk of missing deficiencies during the night time inspections as much of the work as possible should be completed during the day using single lane closures. An example would be the use of single left and right lane closures during the day to inspect the post, base, foundation and truss to post connections. The night time work would therefore be restricted only to the interior traveled lanes focusing just on the truss welds and sign connections. Instead of a full hands on inspection with frequencies recommended in the 'Inspection Frequency' section of these guidelines, a modified strategy might be needed. This may be an alternate cyclic combination of hands on and shoulder inspections to minimize the full lane closures.

## 11.4 Safety

It is highly recommended that every ancillary structure inspection program have a detailed safety plan submitted prior to work commencing. Sign structure inspections are one of the most hazardous types of structural inspections. They usually occur adjacent to live traffic. The sign structures are many times located at the 'gore' or exit areas of high speed roads where work zone safety setups can be extremely difficult to setup. In addition, it is routine that the inspector 'climb' the structure, which are complicated due to angled diagonals and slippery structural members.

When climbing a sign or other ancillary structure a two lanyard system offers the best protection with one lanyard always secured to the structure, see Figure 19. Good gripping boots similar to ones a mountain climber would use are recommended. To perform a climbing inspection everything worn or carried by the inspector must be securely attached to him/her so nothing can drop or hang below the bottom of the structure. The reporting of inspection findings may be handled by use of a radio attached to the inspector through which findings are relayed to a notetaker on the ground. Since the traveling public may be concerned when observing someone climbing a sign structure, some states place a variable message sign stating "Workers Overhead" as informational aid.

Listed below are typical contents of a safety plan:

1. Safety Plan Officer for Inspection firm
2. Safety Organization
3. Safety Incident Report Procedures and Forms
4. Fall Safety Specifications
5. Operation of Bucket or lift truck guidelines
6. Hospital Locations
7. Latest Manual of Uniform Traffic Control Devices (MUTCD)
8. Specific work zone traffic setups for 'gore' areas
9. Mandatory personal safety equipment
10. First Aid Kit



**Figure 19. Inspector Uses Double Lanyard System.**

## **12.0 THE INSPECTION PROCEDURE**

With a developed inventory and strategy for inspection, the actual inspection procedures can then be reviewed and implemented.

### **12.1 Pre-Inspection Review of Available Materials (Desk Review)**

The pre-inspection review of information, otherwise referred to as a desk review, should be conducted prior to any ancillary structure inspections. All historical records should be located and reviewed such as as-built design drawings, prior inspection reports, shop fabrication drawings, and previous notes on traffic control. If not already developed a structure folder should be developed containing these items.

### **12.2 Inspection Nomenclature**

Like any structural inspection, orientation and proper nomenclature are important. Nomenclature as to overall structure orientation usually is related to the direction of roadway travel, though details vary from state to state. As an example, Figure 24 shows New York State's nomenclature for the orientation of overhead sign structures. The following sections provide typical nomenclature for ancillary structures.

#### **12.2.1 Sign Bridge**

A structure supporting sign panels or other devices such as variable message signs that span over the traveled way with supports on both sides of the roadway. May also be referred to as a Span Structure. Detailed nomenclature for the various parts is given in Section 12.2.6.

#### **12.2.2 Cantilever Sign Structure**

A structure that extends over traffic and has a support on only one side of the roadway. The specific components are very similar to those of a sign bridge as given in Section 12.2.6.



### **12.2.3 Mast Arm Structure**

A structure that cantilevers over traffic with a single mast arm. This is different than a cantilever sign structure that may have a truss or dual arm as the cantilever support for signs or other attachments. A mast arm usually supports small signs or traffic signals. The primary components are the foundation, base plate, anchor rods, pole to base plate connection, pole, mast arm to pole connection, and mast arm.

### **12.2.4 Signal Supports**

A structure, usually a mast arm type, which supports traffic signals. The primary components are the foundation, base plate, anchor rods, pole to base plate connection, pole, mast arm to pole connection, and mast arm.

### **12.2.5 Light Poles**

A structure supporting lighting, such as a high mast lighting tower. The primary components are the foundation, base plate, anchor rods, pole to base plate connection, pole, and luminaire. High mast poles also have a luminaire raising device and generally a slip joint (or more) in the post.

### **12.2.6 Detailed Nomenclature**

The nomenclature for the various components of overhead sign structures is given below and shown in Figures 20, 21, and 22. The base components for the sign truss are similar to those of other ancillary structures.

Truss – superstructure that is composed of truss members. These can be tubular or angular.

Chords – The main horizontal members of the truss.

Diagonals – The diagonal members of the truss.

Splice – Usually referred to as the connection between the truss chords. May also occur in long mast arms and high poles.

Catwalk – The walkway used by maintenance personnel, usually located in front of the sign.

Foundation – The portion of the sign structure that directs the load into the ground. Usually constructed of concrete pedestal on pile, spread or caisson foundations.

Anchor Rod – The rods that connect the sign structure base to the foundation.

Base Plate – The plate used to connect the post base to the foundation.

Post or Tower – The vertical supporting members of a sign structure.

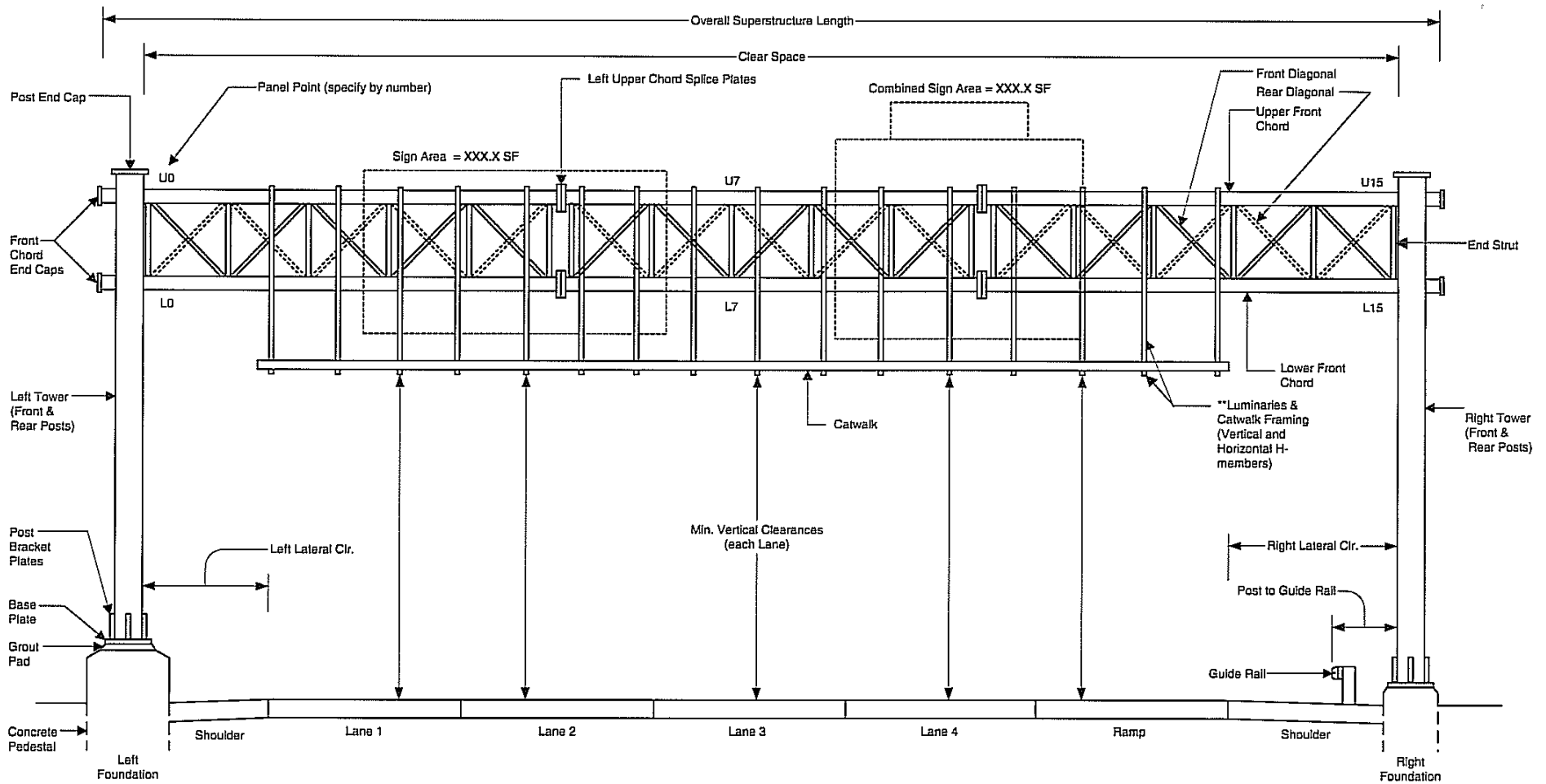

**Figure 20. Nomenclature Associated with Sign Bridge.**

**Note: Use of grout pad is optional.**

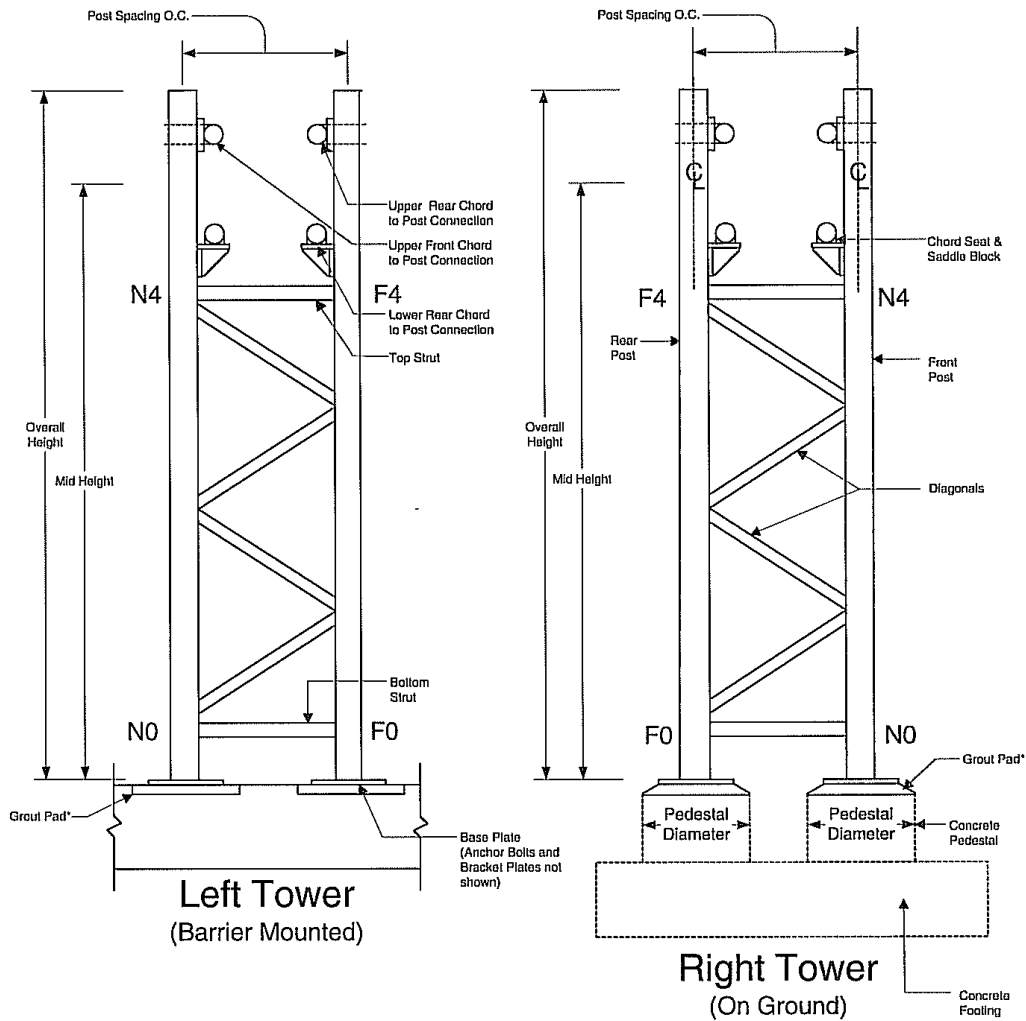
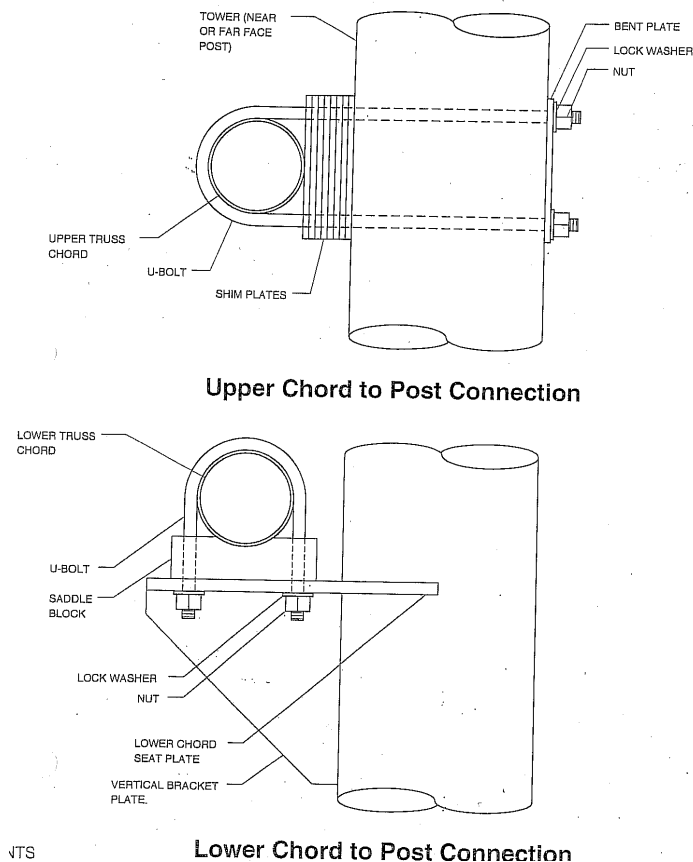

Figure 21. Nomenclature for Ancillary Structure Tower Supports.



**Figure 22. Example-Truss to End Frame Connection Nomenclature.**

Truss Seat – The member that supports the vertical load of the truss.

Handhole – An opening in the sign structure post for access. Usually located 3' above the base plate.

U-bolts – Bolts shaped like the letter 'U' used to attach sign framing brackets to the sign truss.

Saddles – Bearings that support the chords of truss structures.

Shim Plates – Metal plates used to account for elevation differences in tower to truss supports.

Sign Panels – Sign Panels are usually attached to the structure via a Vertical Support Angle (Figure 23). The vertical angle is connected to Horizontal Support Angles. Finally the panel itself is connected to the angle with Sign Clips. Sign panels can be made as one continuous unit or partial units joined together with Backing Strip connections.

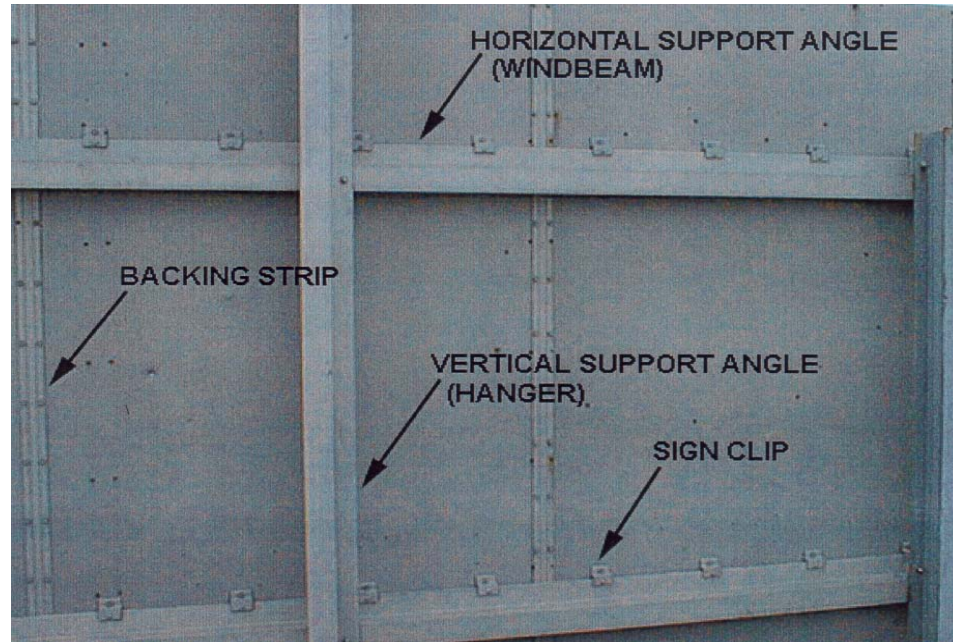

**Figure 23. Sign Panel Support Components.**

### **12.2.7 Orientation of Members**

Members for the sign truss usually follow truss nomenclature. That is, panel points are labeled across the truss and members are labeled according to their beginning and ending panel points. Panel points are labeled left to right as viewed from the front. Chords and Towers are labeled as 'Front', 'Back', 'Upper Front', 'Lower Front', 'Upper Back', and 'Lower Back'. Instead of compass directions signs are normally labeled 'Near Side' and 'Far Side' based on the direction of travel.

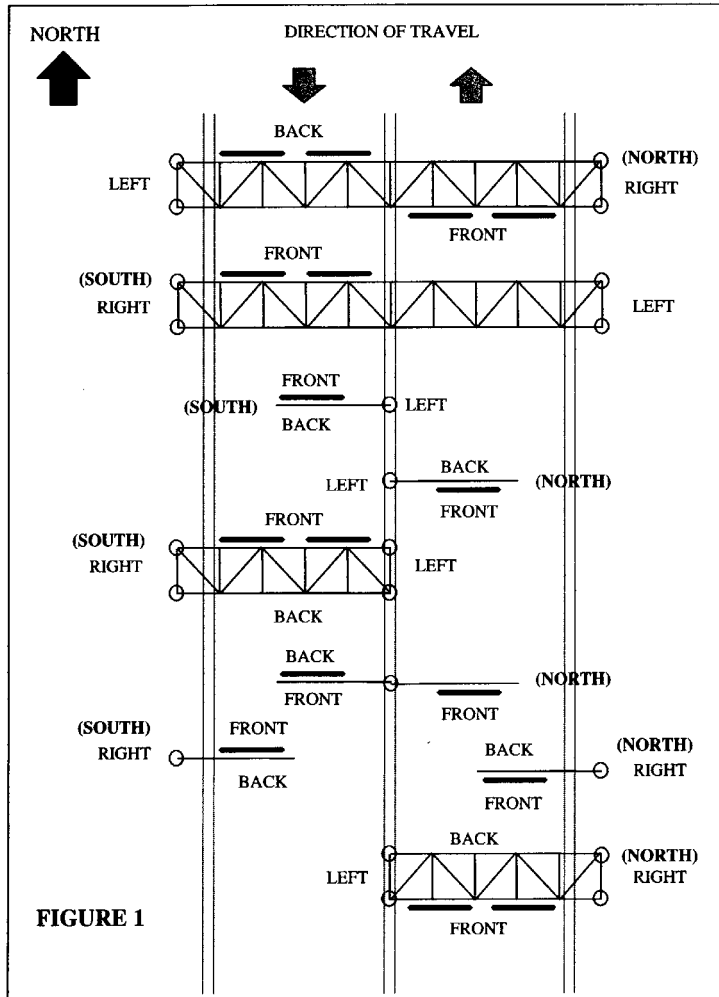

**Figure 24. Orientation of Overhead Sign Structures-  
New York State Department of Transportation.**

### 12.3 Sequence of Inspection

The inspection of ancillary structures requires a 'hands on' approach. To check for structural deficiencies it is necessary for the inspector to access all critical locations, often by climbing. The inspector wears a safety harness with two lanyards so that he/she is tied off to the structure at all times. The inspector carries many tools such as electronic and tape measuring devices, wrenches to tighten loose hardware, marking tools and mirrors to see the underside of welds. Nondestructive testing (NDT) equipment may or may not be required. Figure 25 shows a visual inspection of a chord splice connection for an overhead sign truss.

For structures such as signal supports it is usually possible to conduct the inspection from a bucket truck with minimal traffic disruption. High mast lights may require specialized techniques, which are discussed in Section 12.3.3.



**Figure 25. Hands on Inspection of Overhead Signs.**

### **12.3.1 Sign Structures**

A typical hands on inspection of a sign structure starts at the foundation and works skyward. The foundation, typically made of concrete, is checked for cracks, spalls and other signs of deterioration. Many times drainage pathways in the foundation become blocked with debris not allowing water to escape from the inside of the post. Many structures have grout pads to support the post base. These are often susceptible to deterioration. It is important to check historical documents to see if grout pads were part of the original design. If they were not, many times existing deteriorated pads can be removed.

Post to foundation connections usually consist of anchor rods that transfer the load from the structure post to the foundation. Anchor rods can become corroded over time and fail under fatigue loading. Many anchor rods initially installed might have been too short or too long. If too short, a coupler may have been used that cannot transfer the load. Many long rods are cut or flame torched which may change the mechanical properties of the rod. By 'sounding' the anchor rods with a hammer, an inspector can check both the rod and the surrounding foundation.

Anchor rod nuts should be checked for tightness and general condition. Loose leveling nuts as well as top nuts can lead to load redistribution and overstressing of anchor rods. Nuts should be hammer sounded or checked using a large wrench.

The base plates that the anchor rods go through and support the post base should be checked. Many base plates are found to be broken or warped. Inadequate drainage has also led to advanced corrosion.

The post to base plate weld should be examined for any cracking. Cracking may also be found at the termination of stiffener plates. Close inspection may be required to locate any cracks. All cracks found during the inspection should have their beginning and end points marked on the structure along with the date of inspection using a paint stick.

An important aspect in the inspection of the support posts are the handholes. The handholes themselves, cut into the post, can prove to be areas of weld crack initiation. Handholes allow access for inspectors to see the inside of the post. Much noted corrosion of sign structure posts has occurred inside the post as water and debris accumulate to form a corrosive environment. A quick look inside a handhole, usually located 1 meter (3 feet) above the base, can provide instant feedback on potential corrosion. If there are no handholes a thickness meter (D-meter) should be used to check critical areas for reduced section area. Additional problems with handholes are missing covers or those that cannot be removed due to frozen screws.

The Post/Tower inspection includes identification of proper ventilation to remove any buildup of condensation and a general rating of the tower condition. Posts are frequently found with missing top caps that keep rain out. Many steel posts are galvanized and over time some of the coating begins to wear. Another consideration is plumbness of the post, which could reveal foundation problems, past vehicular impacts or initial erection errors. Especially for out of plumb posts, the vertical clearance of the sign over the traveled way should be checked.

The Post/Tower to truss connections should be checked for missing fasteners or misalignment. Span or bridge structures often have saddles and U-bolts at the truss to post connections. These should be examined for missing or loose nuts and cracked castings. Cantilever trusses are generally connected with high strength bolted flange connections. These should be examined for fit-up and loose or missing bolts.

Once the Post/Tower is inspected the process moves to the horizontal truss or mast arm. Many truss members have welded connections that need to be checked. Failed welds in aluminum structures have been a major source of concern. It is very hard to access these welds and may involve the use of climbing the truss, an aerial lift device such as a bucket truck, and special tools such as mirrors. However, all areas must receive an arm's length inspection if cracks are to be found.

Sign trusses are usually fabricated into smaller sections and erected at the site. The truss chord connection is the critical connection between these sections. A flanged splice connection may contain both bolted and welded connections. Since chords are critical truss members their connections are critical as well. Connection fit-up, loose and missing bolts, and weld cracks should be areas of concentration during the inspection.

Sign Panels should be inspected while the truss is undergoing an inspection. Many sign panel fasteners become loose over time. Inspectors are routinely asked to hand tighten these fasteners to avoid another lane closure for such a small maintenance item. A large problem in many states is the use of larger sign text fonts, which result in larger sign panels. This can be dangerous if the original structural designer did not account for such changes. Larger sign panels will result in more wind loading on the structure. An inspector should also be aware of anything mounted on a sign structure that could increase the wind load. The area of sign panels and other attachments should be noted so they can be compared to original design conditions.

After the aerial inspection of all structural members is complete the inspection should proceed to any supplemental elements such as walkways, also referred to as catwalks, electrical components, and other elements that do not comprise the actual structural system.



### 12.3.2 Mast Arm Structures and Signal Supports

The inspection of mast arm structures and signal supports proceeds generally the same as for a sign structure, working from the base on up, see Figure 26. For many of the mast arm and signal supports, the anchor rod nuts are covered by a cap. These must be removed to examine the top nuts, even if removal results in damage. Damaged caps should be reported for future replacement, or the inspection team may be supplied with spares for installation.



**Figure 26. Inspection of a Mast Arm Structure.**

If hand hole covers cannot be removed to check for internal corrosion, an ultrasonic thickness gauge should be employed to check the pole thickness and possible internal corrosion.

The mast arm to pole connection should be carefully examined. A wide variety of post to arm connections are used. Loose and missing bolts, misaligned fasteners, and weld cracks are often found (Figure 27). Mast arm to post connections where the post connection consists simply of two side plates welded to the pole with a face plate that accepts the bolted arm connection have been found especially susceptible to cracks at the plate to post welds.



**Figure 27. Post to Arm Connection Showing Poor Fit-Up Due to Use of Incorrect Components.**

Any splices in the mast arm should be inspected, and the inspection may include the signal to mast arm connection and any signs or panel connections to the arm. Where these areas are to be inspected, traffic control is normally required to allow access from a bucket truck.

### **12.3.3 Light Poles and High Mast Lights**

Inspection of luminaire supports, including high mast lights, generally proceeds from the ground up as for sign and other structures. Access for inspection can generally be gained by use of bucket trucks. However, for high mast lights sufficiently long booms to reach all parts may not be available and it is often impractical to access the location of the light pole with these very large bucket vehicles. Alternative means of inspection “access” are discussed later in this section.

For luminaire supports of modest height, say under 40 feet, anchor bolt inspection may require removal of bolt covers. Because these poles may oscillate however slightly in even modest winds, it is recommended that anchor bolt nuts be checked at both the beginning and end of the inspection. Leveling nuts should also be checked if accessible. Figure 28 shows loose leveling nuts on a high mast structure.



**Figure 28. Loose Leveling Nuts on a High Mast Structure.  
(Note: Top Nuts on Chairs Out of Photo)**

Hand hole or other access covers near the base of the pole should be removed and the interior examined for moisture and corrosion. High mast lights usually have the apparatus for lowering the luminaire ring located inside the base of the pole. Checking the operation of this system is not normally part of the structure inspection. However, the apparatus is normally supported by steel members connected to the inside of the pole and these should be examined for loose connections and weld cracks and defects as these can migrate into the pole.

High poles may consist of more than one section. These are “spliced” by use of a slip joint, as shown in Figure 29, in which the upper segment simply slips over the lower segment. The condition of this joint should be examined for cracks, deformation along the base of the connection, and rust stains. Slip joints, partly because of the tendency of water to be drawn into them by capillary action, sometimes experience corrosion between the two segments. This can lead to the build up of pack rust, particularly in weathering steel poles, that may lead to a vertical crack emanating from the bottom of the upper pole segment.

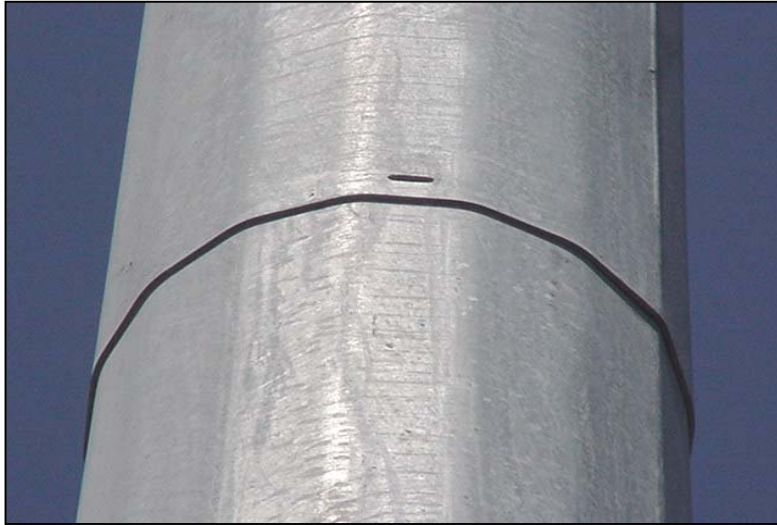

**Figure 29. High Mast Pole Slip Joint.**

Inspection of the luminaire ring is not usually part of the structural inspection. However, visual observation of any defects should be recorded for future inspection by appropriate personnel. Some defects noted in the luminaire ring may relate to mechanical or structural components and should be examined further. Figure 30 shows a misaligned luminaire ring which was found to be the result of a broken support cable.



**Figure 30. Misaligned Luminaire Ring.**

Due to the difficulty of accessing pole splices and luminaire rings, particularly in the high poles that are now common, inspection techniques other than arms length inspection are normally used for these areas. Inspection is normally visual and is made using a pair of binoculars of at least ten power magnification or a telescope such as a shooter's spotting telescope. Telescopes offer higher magnification, with the ability to identify smaller cracks. Several efforts have also been made to develop a remotely operated inspection device that can climb the pole

while carrying a video camera and possibly other inspection equipment. Figure 31 shows one such device, developed by the Virginia Transportation Research Council. At present, these devices are difficult to maneuver and position and require increased inspection time. With continued development; however, they may become a tool for routine inspections, particularly of slip joints.



**Figure 31. Remotely Operated Inspection Device.**

#### **12.4 Non Destructive Testing**

Non Destructive Testing (NDT) is an important tool used for the inspection of ancillary structures. While visual inspection is the primary inspection method, it cannot detect all structural deficiencies. Examples include small fatigue cracks in welds, corrosion occurring on the interior of the structural element, and cracked anchor rods. A list of NDT Methods and their application to ancillary structures is given below.

- ◆ Ultrasonic thickness 'D meter' measurements – Probably the most critical NDT for ancillary structures since failures have been attributed to interior element corrosion that cannot be visually detected (Figure 32). A simple ultrasonic thickness gauge can also be used to check anchor rod lengths and for possible fractures. More sophisticated ultrasonic flaw detection equipment can be used to examine anchor rods for possible cracks or other flaws. A test procedure for anchor rods is contained in Appendix B (Figure 33).
- ◆ Dye Penetrant Test – Excellent test for exposed welds in non-ferrous materials such as aluminum, as well as steel structures. It is usually used to confirm visual observation of a crack. Dye penetrant can help distinguish between cracks and surface defects such as galvanizing flaws which are crack like in appearance. Dye penetrant can only detect surface cracks.

- ◆ Magnetic Particle Test – Excellent test of exposed welds in metallic materials such as steel, Figure 34. This technique can reveal “near surface” cracks as well as surface cracks.
- ◆ Eddy Current Test – Used for painted sign structures or aluminum structures to detect weld cracks where magnetic particle testing does not function due to lack of magnetic attraction.

It is important that the person conducting the test, as well as the personnel interpreting the test data, be properly trained in the applied method. Additional qualifications should include both an understanding of the theory behind the test and practical experience. All inspection methods should be conducted in accordance with applicable American Society for Nondestructive Testing (ASNT) procedures, American Society for Testing and Materials (ASTM) standards, and American Association of State Highway and Transportation Officials (AASHTO) specifications.

Nationally recognized certifications in NDT are provided through ASNT. Since many of the tests performed on ancillary structures are fairly standard and specific in nature, certifications in these particular tests may be an acceptable alternative to full ASNT certification for those engaged in ancillary structure inspection.



**Figure 32. Thickness Measurement at Critical Location of Structure Post.**



**Figure 33. Ultrasonic Testing of Anchor Rods.**



**Figure 34. Magnetic Particle Inspection of Weld at Post to Base Plate Connection.**

## **12.5 Quality Control Plan**

Every ancillary structure inspection program should include a Quality Control Plan. The plan should address consistency in the inspection process and repair recommendations. The plan should address personnel qualifications as discussed earlier in these guidelines. It is important to remember that ancillary structures are a ‘different animal’ unlike bridges and need to be viewed from that perspective.

### 13.0 ELEMENT INSPECTION

Inspection findings are reported in a variety of ways. In keeping with bridge inspection methodology a number is normally assigned to structures or their components that represent their condition. In order to provide consistency with current bridge inspection reporting, an element based inspection reporting system is recommended.

#### 13.1 Element Definitions

Each owner should develop an inspection reporting system consistent with their particular needs and asset management procedures. Various element level reporting formats including PONTIS based systems have been utilized, as illustrated by the examples in Appendices B and C. The PONTIS based systems, as presented in Section 14, provide for quantifying both elements and the extent of defects. However, they typically do not include nonstructural information on “elements” such as vertical clearance or adjacent guard rails that may be of interest and not readily available elsewhere.

The eighteen (18) elements shown in Table 9 are recommended for use in rating Highway Signs, Luminaries, and Traffic Signals where a PONTIS based system is not utilized. Note that all elements may not be applicable to a specific structure type.

**Table 9**

**Element Definitions**

Element Number	Description
S.01	Foundation - This element includes foundation(s) that are constructed of reinforced concrete or steel. Inspectors should assign ratings based on the overall condition of the foundation and its ability to function properly. The condition of grout pads, if present, shall also be included in this element.
S.02	Anchor Rods - This element defines anchor rods, anchor nuts, leveling nuts, and washers connecting the column support members to the foundation.
S.03	Base Plate(s) - This element defines the base plates, flanges, gusset plates and welds at the connection of the column support(s) to the foundation(s). The elements may be painted, unpainted, or galvanized.
S.04	Tower(s) - This element includes the vertical posts, truss members, handhole covers, and caps for the column supports on the structure. Flange and gusset plates at the column to span arm/chord connection are also included with this element. The element components may be painted/unpainted/galvanized steel or aluminum. This element includes posts for cantilever structures such as high mast lights.
S.05	Tower to Truss Chord/Arm Connection(s) - This element defines the flange and gusset plates connecting the span arms or chords to the column supports. The element components may be painted/unpainted/galvanized steel or aluminum.



Element Number	Description
S.06	Truss Chords/Arms - This element defines the truss frame members. The element components may be painted/unpainted/galvanized steel or aluminum. Weld cracks or connection defects on truss members are to be recognized as critical.
S.07	Truss Struts – This element defines the secondary truss members: the diagonal, horizontal, or vertical struts, the diagonals and the cross bracing. The element components may be painted/unpainted/galvanized steel or aluminum. Weld cracks or connection defects on truss members are to be recognized using the appropriate element.
S.08	Cracks - This element addresses cracks in members or welds on any structure element, particularly vertical, horizontal and diagonal truss members. In general, the less redundant an item is, the more critical a deficiency in that item becomes.
S.09	Chord Splice Connections - This element defines the splice(s). The element components may be painted/unpainted/galvanized steel or aluminum. This element should also be used for pole slip joint connections.
S.10	Sign Frame and L Brackets - This element defines the L-brackets, vertical hangers, horizontal braces, and other structural members that mount the sign panels to the sign arms, chords, or bridge girders (bridge-mounted signs only). Unit quantities should reflect each individual L-bracket or hanger. Item also includes sign clips (if used).
S.11	Sign Panels - This element defines the sign panel of the sign structure. This rating shall include the legibility of the sign, as well as the condition of the structural elements.
S.12	Catwalk - This element defines the walkway gratings, handrails, safety chains, and connections on the sign structure. The element may be painted, unpainted, or galvanized steel or aluminum.
S.13	Power and Luminaries - This element defines the visual condition of any luminaries in the lighting system on the sign structure, as well as the visual condition of any electrical lines and boxes.
S.14	VMS Sign - This element identifies a Variable Message Sign (VMS) mounted on the structure.
S.15	Sign Attachments - This element defines each accessory on the sign structure including dampeners, signs mounted on the tower, traffic-control devices and cameras.
S.16	Vertical Clearance, Camber and Alignment - This element defines the vertical clearances involving the structure, as well as the overall status of the alignment of the structure.
S.17	Protection, - This element defines the state of the devices such as guardrails protecting the structure. Evaluate for a distance of no more than 300' from the structure.

Element Number	Description
S.18	Other, - List any elements that do not fall into any category listed above. List each item and state condition.

Element S.08 'Cracks' is an interesting rating since it is not specific to an element, rather a condition. This element rating, proposed by the New Jersey Department of Transportation, allows a condition rating to be applied to a crack such as one would find in an aluminum sign truss. It allows the inspector to better define if the crack presents a future danger, such as the structure reaching its fatigue life, or just a maintenance or flaw in initial construction.

Note also that Elements S.11, S.13, S.14, S.16, and S.17 provide various nonstructural information on the ancillary structure.

For each of the eighteen elements, example ratings are provided in Appendix A 'Example Element Ratings'.

#### 14.0 ELEMENT CONDITION RATING

An element rating system should be developed to properly assess the current performance against the originally intended function. There are many numerical rating systems used around the country for structural elements. Since these ancillary structures are usually not as complicated as most bridge structures, it is recommended that a simple '0' to '4' rating system be used as defined in Table 10.

**Table 10**

**Element Condition Rating**

Condition	Description	Feasible Action
0	Not Applicable	None
1	Element performs intended function with high degree of reliability (Good)	None
2	Element performs intended function with small reduction in reliability (Fair)	Repair element, increase inspection frequency, do nothing
3	Element performs intended function with significant reduction in reliability (Poor)	Repair or replacement of element within specified time frame
4	Element does not perform intended function with any degree of reliability (Critical)	Immediate repair or replacement of element

An example inspection form developed by South Carolina and based on an element level system is contained in Appendix B. In this case a rating scale of 1 to 5 was used, but is otherwise similar to that in Table 10.

## 14.1 PONTIS Element Definitions and Ratings

To better correlate with bridge ratings that follow the PONTIS system, this section provides guidance for its application to ancillary structures. A sample report is provided in Appendix B. This approach defines commonly recognized structural elements (CoRe elements) used for sign and high mast light inspections. The following CoRe elements are recommended for use with ancillary structures:

- Foundation(s)
- Anchor bolt(s)
- Base plate(s)
- Column support(s)
- Column to arm/chord connection
- Arm/chord member
- Chord splice connection
- Span truss members
- Sign frame
- Sign panels
- Catwalk
- Luminaire
- Sign attachment
- Slip joint

Each CoRe element of an inspected structure can be evaluated and rated based on the rating guidelines presented in this section. Each CoRe element was assigned a standard unit type to quantify it. For example, the catwalk element is defined in terms of linear feet. If the entire catwalk measured 20 linear feet and minor deficiencies were observed on 5 feet of the element, 15 feet would be allocated as condition state 1, and 5 feet would have be allocated as condition state 2. The rating guidelines that follow provide element descriptions, units of measure, condition state descriptions, and feasible corrective actions for each CoRe element. Each CoRe element listing also considers the material composition and any protective coatings present. A Smart Flag should be used to identify member or connection cracks. The designation “DN” as a feasible action stands for do nothing.

### **Foundation(s) S.01**

**Units: EA**

This element includes foundation(s) that are constructed of reinforced concrete or steel. Inspectors should assign ratings based on the overall condition of the foundation and its ability to function properly. The condition of grout pads, if present, shall also be included in this element.

### **Condition state descriptions**

- 1 Good: The element shows no deterioration. There may be discoloration, efflorescence, and/or superficial cracking in the concrete but without affect on strength and/or serviceability. There is no evidence of active corrosion of the steel. On metal foundations, the surface coatings are sound and functioning as intended.

*Feasible Actions:*     *DN*                     -                     -



- 4 Poor: Heavy corrosion of the elements may be present. Bolts may be cracked/sheared or multiple anchor nuts are loose/missing. There is sufficient concern to warrant an analysis to ascertain the impact on the strength and/or serviceability of the element and/or the sign structure.

*Feasible Actions:*      *DN*                      *Repair Element*                      *Replace Element*

- 5 Not Inspected: The anchor bolts are buried and/or inaccessible.

*Feasible Actions:*      *DN*                      *Remove soil and inspect element*

**Base Plate(s)      S.03**

**Units: EA**

This element defines the base plates, flanges, gusset plates and welds at the connection of the column support(s) to the foundation(s). The elements may be painted, unpainted, or galvanized.

**Condition state descriptions**

- 1 Good: No evidence of active corrosion. Surface coating is sound and functioning as intended to protect the metal surface.

*Feasible Actions:*      *DN*                      -                      -

- 2 Satisfactory: Minor surface corrosion present.

*Feasible Actions:*      *DN*                      *Clean and resurface*                      -

- 3 Fair: Any protective coating present has failed. Surface pitting may be present but any section loss due to active corrosion is measurable and does not warrant structural analysis.

*Feasible Actions:*      *DN*                      *Clean and resurface*                      -

- 4 Poor: Cracks may be present on the base plate to column support connection weld. Corrosion is advanced. Section loss is sufficient to warrant structural analysis to ascertain the impact on the ultimate strength and/or serviceability of the element and/or the sign structure.

*Feasible Actions:*      *DN*                      *Repair element*                      *Replace Element*

- 5 Not Inspected: Element is buried and/or inaccessible.

*Feasible Actions:*      *DN*                      *Remove soil and inspect*                      -

**Column Support(s) S.04**

**Units: EA**

This element includes the vertical posts, truss members, handhole covers, and caps for the column supports on the structure. Flange and gusset plates at the column to span arm/chord connection are also included with this element. The element components may be painted/unpainted/galvanized steel or aluminum.









3 Fair: Significant deterioration or impact damage may be present. Multiple connection components may not be fully engaged. Multiple loose/missing backing strip nuts may be observed that could significantly affect the strength and/or serviceability of either the element or the sign structure. Connection hardware may need replacement.

*Feasible Actions:*     *DN*                     *Rehab Unit*                     -

4 Poor: Connection components may be cracked, sheared, or missing nuts. Cracks may be observed on the welds. There is sufficient concern to warrant an analysis to ascertain the impact on the strength and/or serviceability of the element and/or the sign structure.

*Feasible Actions:*     *DN*                     *Replace Unit*                     -

5 Critical: Any collision damage or deterioration significant enough to threaten collapse or separation from the sign structure.

*Feasible Actions:*     *DN*                     *Remove from service*             *Replace Unit*

**Sign Panels     S.10**

**Units: SF**

This element defines the sign panel of the sign structure. This rating shall include the legibility of the sign, as well as the condition of the structural elements.

**Condition state descriptions**

1 Good: The elements are in new or like-new condition with no misalignment.

*Feasible Actions:*     *DN*                     -                     -

2 Satisfactory: Minor loss of element legibility due to dulled paint or reflectorization. A few loose or missing backing strip nuts may be observed on back of the panels.

*Feasible Actions:*     *DN*                     *Rehab Unit*                     -

3 Fair: Graffiti, vandalism, or collision damage may be present but not affecting element legibility. Moderate deterioration or impact damage to panels or connecting components.

*Feasible Actions:*     *DN*                     *Rehab Unit*                     *Replace Unit*

4 Poor: Signs are difficult to read for any reason. Significant deterioration or damage to the sign panel and/or connecting components.

*Feasible Actions:*     *DN*                     *Replace Unit*                     -

5 Critical: Any collision damage or deterioration significant enough to threaten collapse or separation from the sign structure.

*Feasible Actions:*     *DN*                     *Remove from service*             *Replace Unit*

**Catwalk     S.11**

**Units: LF**

This element defines the walkway gratings, handrails, safety chains, and connections on the sign structure. The element may be painted, unpainted, or galvanized steel or aluminum.

### Condition state descriptions

- 1 Good: The connections are in new or like-new condition with no significant deficiencies or evidence of active corrosion.  
*Feasible Actions:*     *DN*                     -                     -
- 2 Satisfactory: Minor damage or deterioration of the element may be observed. Connections may have loose nuts but have no significant deficiencies.  
*Feasible Actions:*     *DN*                     *Rehab unit*                     -
- 3 Fair: Moderate deterioration of the connections may be present. Handrails and locking pins may be misaligned or inoperable. Safety chain(s) may be missing or deteriorated.  
*Feasible Actions:*     *DN*                     *Rehab unit*                     -
- 4 Poor: Sections of gratings or handrails may be misaligned, unstable, damaged or missing. Damage is sufficient to warrant structural analysis to ascertain the impact on the ultimate strength and/or serviceability of the element. Heavy deterioration of the connections may be present.  
*Feasible Actions:*     *DN*                     *Rehab unit*                     *Replace Unit*
- 5 Critical: Any collision damage or deterioration significant enough to threaten collapse or separation from the sign structure.  
*Feasible Actions:*     *DN*                     *Rehab unit*                     *Replace Unit*

### Luminare     S.12 Units: EA

This element defines each luminare in the lighting system on the sign structure.

### Condition state descriptions

- 1 Good: Elements is fully functional and in new or like-new condition with no significant deficiencies.  
*Feasible Actions:*     *DN*                     -                     -
- 2 Satisfactory: Minor damage of the element may be observed. Element may be misaligned.  
*Feasible Actions:*     *DN*                     *Rehab unit*                     -
- 3 Fair: Light cover latches are broken or rusted shut. Missing cover plates. Loose, broken or missing sections of conduit. Open electrical boxes.  
*Feasible Actions:*     *DN*                     *Rehab unit*                     -
- 4 Poor: Broken or missing covers. Burned out bulbs/ballasts or missing light fixtures. Exposed wiring or unattached electrical boxes.  
*Feasible Actions:*     *DN*                     *Rehab unit*                     *Replace Unit*
- 5 Critical: Any collision damage or deterioration significant enough to threaten separation from the sign structure.  
*Feasible Actions:*     *DN*                     *Rehab unit*                     *Replace Unit*

**Sign Attachment S.13**  
**Units: EA**

This element defines each accessory on the sign structure including dampeners, signs mounted on the column supports, traffic-control devices and cameras.

**Condition state descriptions**

- 1 Good: Element is fully functional and in new or like-new condition with no significant deficiencies.  
*Feasible Actions:*     *DN*                     -                     -
  
- 2 Satisfactory: Minor damage, deterioration, or misalignment of element may be observed.  
*Feasible Actions:*     *DN*                     *Rehab unit*                     -
  
- 3 Fair: Moderate damage or deterioration of element, however the element remains functional.  
*Feasible Actions:*     *DN*                     *Rehab unit*                     -
  
- 4 Poor: Serious damage or deterioration to element is reducing the functional performance of the unit.  
*Feasible Actions:*     *DN*                     *Rehab unit*                     *Replace Unit*
  
- 5 Critical: Any collision damage or deterioration significant enough to threaten separation from the sign structure. Any exposed wiring or other dangerous condition.  
*Feasible Actions:*     *DN*                     *Rehab unit*                     *Replace Unit*

**Slip Joint S.14**  
**Units: EA**

This element defines the slip joint connection on high-mast light structures.

**Condition state descriptions**

- 1 Good: Element is in new or like-new condition with no significant deficiencies.  
*Feasible Actions:*     *DN*                     -                     -
  
- 2 Satisfactory: Misalignment or minor corrosion of element may be observed.  
*Feasible Actions:*     *DN*                     -                     -
  
- 3 Fair: Minor cracking of element or moderate corrosion. There is not sufficient concern to warrant an analysis to ascertain the impact on the strength and/or serviceability of the element and/or the sign structure.  
*Feasible Actions:*     *DN*                     *Repair unit*                     -
  
- 4 Poor: Cracking of element or significant corrosion. There is sufficient concern to warrant an analysis to ascertain the impact on the strength and/or serviceability of the element and/or the sign structure.  
*Feasible Actions:*     *DN*                     *Rehab unit*                     *Remove from service*

- 5 Critical: Structure is in imminent danger of collapse. Multiple elements warrant ultimate strength and/or serviceability analysis.

*Feasible Actions:*     *DN*                    *Remove from service*     -

**Weld Crack (Smart Flag)   S.15**

**Units: EA**

This smart flag addresses cracks in welds on any sign structure element, particularly vertical, horizontal and diagonal truss members. In general, the less redundant an item is, the more critical a deficiency in that item becomes. This smart flag only refers to weld cracks. Other cracks should be identified in the rating for the appropriate element effected.

**Condition state descriptions**

- 1 Minor: One or two minor “weld pool” cracks are present. Cracks that are short in length and shallow in depth, which may be grinded out for repair. This rating would also encompass incomplete welds or other minor fabrication defects in welded connections of truss members.

*Feasible Actions:*     *DN*                    *Monitor condition*                *Repair unit*

- 2 Fair: Several weld pool cracks are present, or a hairline crack exists at one or two redundant members. There is not sufficient concern to warrant an analysis to ascertain the impact on the strength and/or serviceability of the element and/or the sign structure.

*Feasible Actions:*     *DN*                    *Monitor condition*                *Repair unit*

- 3 Poor: Several hairline cracks are present, a single crack has visible width, or the welded connection has been severed on a redundant truss member. Any condition where there is sufficient concern to warrant an analysis to ascertain the impact on the strength and/or serviceability of the element and/or the sign structure.

*Feasible Actions:*     *DN*                    *Repair/rehab unit*                *Remove from service*

- 4 Critical: Crack has propagated into a non-redundant structural member (i.e. column or chord), or the welded connection has been completely severed. Multiple cracks on structure have created a condition such that the structure is in imminent danger of collapse.

*Feasible Actions:*     *DN*                    *Remove from service*     -

**15.0 INSPECTION REPORT**

Reporting of deficiencies, condition ratings, and notification of any critical conditions can occur in a number of ways. Many agencies have opted for an electronic process, either using hand held devices or laptop computers to record information out in the field. It is important, whether using a paper reporting procedure or an electronic system, that all aspects of the report be finalized before leaving the site.

The inspection report should summarize many aspects of the inventory and inspection process but first and foremost identify deficiencies that may require maintenance or result in structural failure. The report is used as a tool to manage the ancillary structure inventory and must be complete, concise, and accurate. It should clearly call out any recommendations for further action. A recommended list of items to be included in a typical inspection report are listed below:

- ◆ Inventory Information
- ◆ Personnel / Firm / Inspector information
- ◆ Inspector Ratings
- ◆ Inspector Repair Recommendations (May include prioritization. See Section 16.1)
- ◆ Inspector Recommendation on Inspection Frequency
- ◆ General Photos
- ◆ Deficiency Photos
- ◆ Sketches
- ◆ NDT Results (if applicable)

Inspection reports may take any number of forms. Most reports are submitted as electronic files, either as individual reports or part of a database management system. For documentation purposes, a paper copy, signed by the responsible party, is also normally required.

An example inspection report for a New Jersey Sign Structure utilizing an element based inspection system is located in Appendix C. An example inspection report in the PONTIS system is located in Appendix B.

## **16.0 MAINTENANCE AND REPAIR**

### **16.1 Prioritization of Work**

A protocol should be developed whereby deficiencies identified during the inspection can be addressed in a timely manner. The repair priority rating system given in Table 11 is one example. If Priority 1 repairs cannot be made within a reasonable timeframe, removal of the sign structure may be warranted.

**Table 11**

**Repair Priority Rating**

Condition	Description	Repair Timeframe
0	Not Applicable	None
1	Items, if not corrected immediately, threaten the continued operation of the structure	3 days
2	Items that need to be corrected in a timely manner, above normal maintenance repairs.	One Year
3	Items that can be corrected during normal maintenance operations.	Three Years

For emergency situations, a Condition 'E' can be applied whereby the roadway may have to be immediately shut down. The inspection team should have a direct contact person to notify if any critical conditions are found. There have been cases where the inspection team and their traffic control remained on site while maintenance personnel and equipment mobilized to the site and removed structures found in critical condition. Many states have such procedures for bridge inspectors, and a similar protocol can be followed for ancillary structures.

Overhead sign structures can vary in cost from \$10,000 to \$150,000 depending on complexity. In comparison to other highway structures such as bridges, this is a relatively minor cost. For this reason many states that have found structurally deficient sign structures, decide on total removal and replacement rather than repair. If repairs are made it may be only a temporary measure. Some deficiencies like cracked welds, even if found on only one or two elements, are indicators that the structure has most likely reached its fatigue life and replacement is warranted.

Of course each sign structure should be evaluated on cost/benefit value when considering repair or replacement. Other factors such as traffic control could greatly add to the cost of total replacement.

## **16.2 Routine Maintenance**

Ancillary structures, especially sign bridges, typically require lane closures and disruption of traffic flow, in order to access the structure for repairs and thus the inspector may be asked to perform routine maintenance at the time of the inspection. If not performed by the inspection team, this work should be completed by maintenance crews in a timely manner. Examples of deficiencies that require typical routine maintenance are:

- ◆ Loose nuts
- ◆ Loose or missing sign fasteners
- ◆ Broken washers
- ◆ Buried foundations
- ◆ Clogged post drainage
- ◆ Excessive vegetation
- ◆ Rodent droppings
- ◆ Spot loss of galvanization
- ◆ Replacing pole caps, hand hole covers, anchor rod caps

### **16.2.1 Foundations**

Routine Maintenance for foundations includes making sure that the foundation is visible to the inspector. If buried, this can accelerate corrosion and will not yield a full inspection. Many times not only are the foundations buried but the base plates and anchor rods are as well. This can be attributed to the widening of many highway shoulders where ancillary structures are positioned.

Drainage issues are very important for sign structures. Many structures are inspected and found to have standing water in the post. Drilling a small hole in the post to allow drainage or creating drain grooves in the top of the foundation can easily be done during routine maintenance. Blocked drain grooves are the most problematic maintenance item that can lead to catastrophic results. Inspectors and/or maintenance personnel should routinely clean the outlet simply using a screwdriver head or other probing tool.

Buried foundations should be uncovered and area around them regraded. Any buried foundations should be exposed to at least .3m (1 ft.) below the top of the foundation. Any excessive vegetation should be removed since it not only impedes inspections but harbors moisture and rodents.

Missing handhole covers can be a safety concern especially if electrical power is inside the post. Also, moisture, animals, birds and garbage can enter the handhole. It is recommended that all missing handhole covers be replaced. Missing post or truss end caps have the same potential problems and should be replaced. In addition to handholes sometimes there are conduit access holes, usually small holes 25mm to 50mm (1 inch to 2 inches) in diameter that allow small birds and insects to enter. An easy repair is to plug the hole with a plastic conduit end cap. A small hole may be drilled through the cap to allow airflow.

### **16.2.2 Connections**

Missing or loose anchor rod nuts, both top nuts and leveling nuts, can be a serious problem since the load is then transferred to the adjacent rods. In many older cantilever structures there are only a total of four rods, so just one missing or loose nut can overload the remaining three rods. Damaged nuts should be replaced and loose nuts properly tightened.

Missing, broken, or loose bolts in member connections should be replaced. Consideration should be given to replacing aluminum bolts or black bolts used in structural connections with galvanized high strength bolts.

Many sign structures were constructed with steel towers/posts and an aluminum truss. The lighter aluminum helped to reduce structural loading. However, with these dissimilar metals it is important that the nonconductive materials, such as polymer pads, placed as barriers between the dissimilar materials remain so these materials do not touch and accelerate corrosion. Missing pads should be replaced in a timely manner.

The numerous fasteners that connect sign panels to the structure can loosen and fall off. Missing fasteners should be replaced unless it is determined that sufficient redundancy exists in the connection. A simple rule of thumb might be, fastener replacement is necessary if more than 20 percent of the connections are missing.

### **16.2.3 Coatings**

Many steel structures have been galvanized to slow the corrosion process. Over time the galvanized layer may become ineffective and therefore lose its ability to slow the process of corrosion. Impact damage can also remove the protective coating. If there is minor loss of galvanization a touch up may be prudent. Total loss of galvanization may not be an immediate problem if there is no visible corrosion or section loss, but may result in a shorter structure service life.

Suggestions for routine maintenance of coatings include the following:

- ◆ Clean debris from structure, remove or cut vegetation touching structure.
  - This is particularly important for weathering steel
  - Remove bird droppings that can accelerate corrosion

- ◆ Touch up of galvanizing
  - Repair in accordance with ASTM A780 “Standard Practice for Repair of Damaged and Uncoated Areas of Hot-Dip Galvanized Coatings”
  - The surface should be ground to bright metal
  - A zinc rich paint or cold galvanizing compound should be applied
- ◆ Painted structures
  - Paint must be removed to inspect suspected cracks
  - Repaint immediately after inspection (if OK) or after repair
  - Touch-up paint any scratches or locally defective areas

### **16.3 Repairs**

In recent years many innovative repair methods have been researched and implemented for overhead sign structures. The most progress has been made regarding aluminum truss structures. These welded structures are very difficult to field repair. Even truss removal and repair is considered much more difficult than with a steel truss. The following paragraphs provide repair guidance for typical problems.

#### **16.3.1 Foundations**

##### **16.3.1.1 Concrete**

The foundations of ancillary structures are susceptible to deterioration due to their proximity to the traveled roadway and the influence of surrounding site conditions. Concrete, the most prevalent material type of foundation used, will deteriorate by cracking, delaminating and spalling. These types of deficiencies can be repaired so that the service life of the structure can be maintained.

Deterioration that includes cracking, spalling and delamination can be repaired as would be done with other concrete structures. The deteriorated or damaged concrete can be chipped away and replaced with mortar. Cracks can be sealed with epoxy or epoxy grout depending on their size. Large spall areas can be repaired with reinforcing that is drilled and bonded into the existing foundation for an integral connection.

A common deficiency that typically requires repair for an ancillary structure is the grout pad between the top of foundation and base plate. This mortar type mix is not the reinforced concrete used in other parts of the foundation, and usually serves only to support the steel base plate in compression. One easy repair is to completely remove the grout pad, if analysis can show that the base plate will meet existing buckling specifications without the pad. Once the grout pad is removed the gap area between the foundation and base plate should be closed off with wire mesh to prevent intrusion of debris or rodents into the post base.

If the grout pad is determined by analysis to be required to prevent the base plate from buckling, the grout should be completely removed and replaced using a prepackaged “non-shrink” grout placed in accordance with the manufacturer’s requirements. The grout pad design should accommodate any drainage from the post and provide for adequate air circulation.



### 16.3.1.2 Anchor Rods

This critical connection between the post and foundation has been problematic. Many times the rod is not long enough and the anchor nut is not fully engaged. This in itself is not a serious deficiency as long as at least three quarters of the nut is engaged. If not, a coupler may have to be installed to lengthen the rod. This may involve complete foundation reconstruction. The first course of action is to see if the base plate can be lowered to fully engage the nuts.

A rod that is found to be fractured or does not meet required embedment lengths presents a serious condition. One method of adding anchor rods is to drill through the base plate and into the foundation so that new rods can be epoxy grouted into place, see Figure 35. Installation may be hindered by closely spaced base plate stiffener plates and may cut reinforcing steel in the foundation.

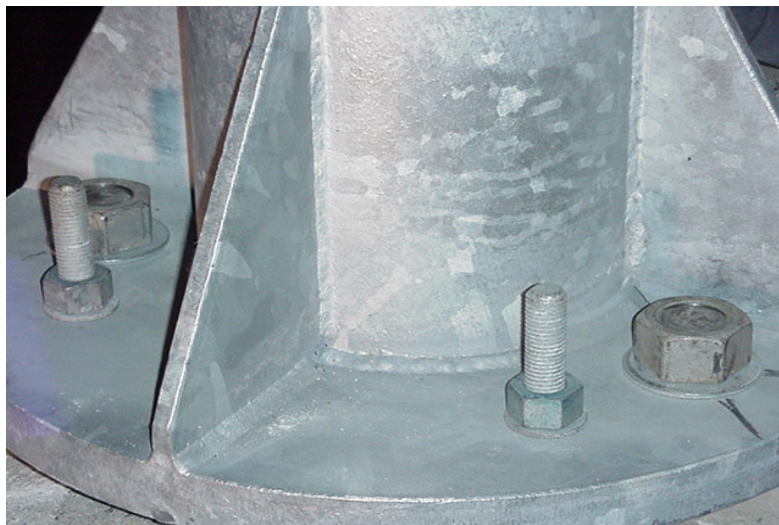

**Figure 35. Base plate with Added Anchor Rods.**

In many states a new foundation is built adjacent to the old and the structure is relocated to the new foundation. For multi-tower sign structures or those with eight or more anchor rods with high redundancy a fractured anchor rod may not be critical. An analysis should be conducted to investigate the effects prior to determining repairs.

When replacing a nut or washer, wire brush and lubricate the anchor rods, use new top nuts and washers, lubricate the nuts, and tighten. Beeswax or toilet ring wax are good lubricants.

### 16.3.2 End Frames and Posts

End frames and posts connect ancillary structures to their foundations and are susceptible to damage from vehicles and maintenance operations. Common deficiencies covered here for repair include gouges, corrosion, impact damage and weld cracking.

### **16.3.2.1 Gouges**

Gouges are common deficiencies in the end frame posts of ancillary structures since they can come in contact with machinery, vehicles and pedestrians. The size of the gouge in relationship to the size of the element will help determine the repair strategy. Gouges greater than 3 mm (1/8 inch) deep but less than half the member thickness may be ground with a transition slope to reduce the possibility of cracking. This repaired member will be more susceptible to fatigue and therefore should be inspected more frequently. Gouges greater than half of the member thickness can also be ground but the reduced structural capacity of the effected area should be investigated.

### **16.3.2.2 Impact Damage**

Damage to end frames and posts due to impact are common. If gouges occur due to impact the proceeding paragraph provides repair guidance. Dents from impact need to be evaluated for reduced structural capacity due to local buckling. All welds in effected members need to be inspected for potential cracking from the impact force. Weld repairs should be made in conformance with the AWS Bridge Welding Code.

### **16.3.2.3 Corrosion**

Where bases of end frames or posts exhibit corrosion, the source of moisture should be removed whenever possible by regrading and removing vegetation. Corroded areas should be properly cleaned and recoated. If corrosion has caused enough section loss to reduce the structural capacity of the member below required values, the area can be strengthened with steel collars or concrete encasement.

## **16.3.3 Trusses and Mast Arms**

Many sign structure trusses are three dimensional space frames. In determining the need and type of repairs to these structures, consideration should be given to the significant redundancy many of them possess. In an unpublished load test of a four-chord bridge structure by the Iowa Highway Department, the structure was able to carry in excess of its design load even when numerous members were totally cut.

### **16.3.3.1 Connections**

Sign structures arrive in sections for transportation and are erected at the site. Many times the connections do not always perfectly fit together. This may not be a serious problem if the gap created by the misalignment covers less than 25 percent of the total faying surface area. If the gap is greater, shims should be used to provide even contact. Shims should not be inserted into a tightened connection; rather, the connection must be loosened, shims inserted, and then retightened.

### **16.3.3.2 Cracks**

Weld crack problems with steel structures are easier to repair than aluminum. The repair may be made 'in-situ' or that portion of the structure can be removed from service and repaired. Corrections to weld problems may include hammer peening, hole drilling to arrest the crack, vee-and-welding, or detail modification.

Hammer peening provides a compressive stress to the weld surface that helps to reduce the tendency to crack and to keep any crack from propagating. It has been useful for fatigue cracks up to 3 mm (1/8 inch) deep. Hammer peening followed by surface grinding can increase the strength of the connection by one fatigue strength category. Ultrasonic Impact Treatment (UIT), sometimes called ultrasonic peening, is a recently developed technique used to treat fillet welds to increase their fatigue strength. This has been used in Texas to treat welds in ancillary structures and is a patented process developed by Applied Ultrasonics.

A drilled hole is often used to arrest a crack that goes through the entire thickness of the weld material. For small cracks this may be enough to arrest the crack permanently, but offers only a temporary fix for larger cracks. The diameter of the hole to be drilled is often taken as 20mm (.75 inch); however, a more structure specific hole size can be calculated based on the stress range, edge distance and yield strength of the material. The inside of the drilled hole should be tested with dye penetrant to assure that the crack end was removed. Figure 36 illustrates actual crack repair details.

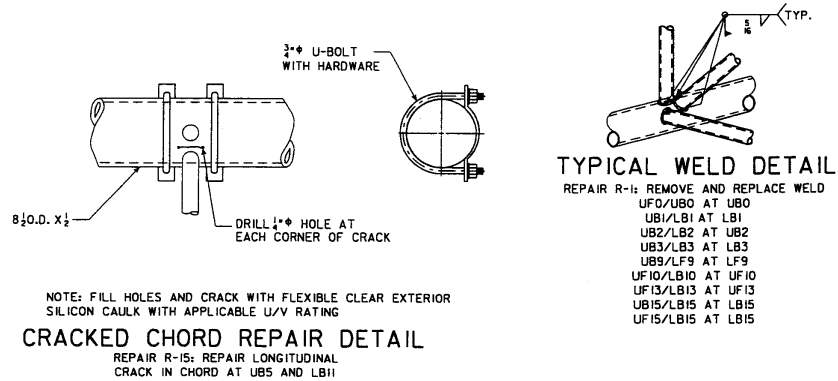

**Figure 36. Repair Detail for Overhead Sign Truss Chord Crack.**

### 16.3.4 Longitudinal Splits or Cracks

Longitudinal splits and cracks generally develop due to freezing of trapped water or build up of packout corrosion in slip joints. Longitudinal cracking at slip joints can also occur due to excessive bending stresses.

Slip joints, or telescoping splices that may develop packout corrosion, particularly a problem with weathering steel, should be sealed around their base with a weld, epoxy, or silicone sealant

If a longitudinal split or crack in a telescoping splice extends beyond the telescoping splice, the pole should be replaced.

If the longitudinal split or crack does not extend beyond the telescoping splice, the pole may be repaired by applying stressed steel bands around the perimeter. A 25 mm (1 inch) diameter hole should be drilled at the end of the split or crack, followed by applying steel bands around the post at the crack. The bands must be designed to replace the strength of the section area

of the cracked length of the member. Poles prone to this splitting can be retrofitted with the bands as a preventive measure. Members with small splits (less than two times the diameter) due to freezing water inside them can also be repaired in this way. Where freezing has occurred, 25 mm (1 inch) holes should be drilled near the bottom of the member and similar members to drain any water. Members with larger splits should be considered for replacement.

### **16.3.5 Composites for Repairs**

Research conducted at the University of Utah for the Utah State DOT and New York State DOT has resulted in a fiber composite wrap that surrounds the deficient weld area and helps transfer the load past the area of damage. It is an attractive repair option since it can be installed in-situ with materials that cost just a few hundred dollars.

#### **16.3.5.1 Material Properties**

The fiber composite wrap is actually a Fiber Reinforced Polymer (FRP). An approved installer that is thoroughly trained by the specific manufacturer should install the material. Surface preparation is critical and installation should only occur during weather deemed acceptable by the manufacturer. Surface preparation can include scrubbing, acid etching, water rinse and air-drying. The cure time for the applied repair resins is usually about one hour.

#### **16.3.5.2 Repair Examples**

A good example of such an application is repair to an aluminum sign truss bridge. During inspection it was found that the welds connecting the diagonals to the chord had cracked over a significant portion of their length. FRP was chosen as a repair technique. The application included member cleaning and application of the FRP material using strips wrapped around the members. Figure 37 below shows the completed application. These repairs, initially thought to be just temporary for one year or less, are now being considered as a permanent repair solution.



**Figure 37. Repair of Truss Members Using FRP.**

### 16.3.6 Vibration Dampeners

Many ancillary structures, especially mast arm type, can visibly be seen vibrating under load. Though structurally sound, the excessive vibration may cause concern to the traveling public. The recommended repair is installation of a dampener to reduce the displacements.

#### 16.3.6.1 Types of Dampeners

The most common type of dampener found on ancillary structures is the Stockbridge damper, also called a dog bone damper, see Figure 38. There are two weights on the end of a flexible shaft that can be tuned based on the natural frequency of the structure and thereby offer maximum effect. They are also very easy to install on existing structures as a retrofit.

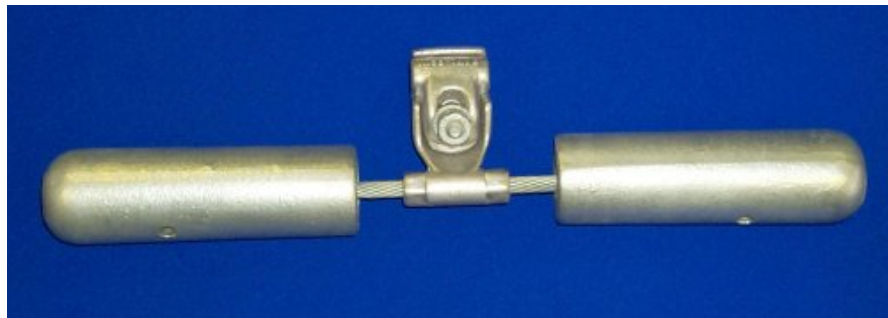

**Figure 38. Stockbridge Damper.**

To counteract galloping of signal arms a flat panel called a sign blank can be installed horizontally directly over the signal head acting as a drag against the up and down motion. The sign blank must be correctly placed over the signal head to break the airflow. This type of dampener has been used in Texas, see Figure 39. Other dampeners developed include the Florida impact damper and the Wyoming strand damper.



**Figure 39. Texas Flat Panel Damper.**

For natural horizontal wind gusts the Wyoming strand damper, Figure 40, is also helpful as is any kind of horizontal strut that can reduce out of plane bending.



**Figure 40. Wyoming Strand Damper.**

## REFERENCES

- ACI 318-99, *Building Code Requirements for Structural Concrete and Commentary*, American Concrete Institute, Farmington Hills, Michigan, 1999.
- Aluminum Design Manual, The Aluminum Association Inc., Washington, D.C.
- American Galvanizers Association, Centennial, CO.
- American Society of Nondestructive Testing, Columbus, OH.
- ANSI/ASME B 1.1, *Unified Screw Threads*, American National Standards Institute, New York, NY, 1989.
- ASTM A36, *Standard Specification for Carbon Structural Steel*, American Society for Testing Materials, West Conshohocken, PA, 1996.
- ASTM A153, *Standard Specification for Zinc Coating (Hot-Dip) on Iron and Steel Hardware*, American Society for Testing Materials, West Conshohocken, PA, 1995.
- ASTM A193, *Standard Specification for Alloy-Steel and Stainless Steel Bolting Materials for High-Temperature Service*, American Society for Testing Materials, West Conshohocken, PA, 1995.
- ASTM A307, *Standard Specification for Carbon Steel Bolts and Studs, 60,000 PSI Tensile Strength*, American Society for Testing Materials, West Conshohocken, PA, 1994.
- ASTM A325, *Standard Specification for Structural Bolts, Steel, Heat Treated, 120/125 ksi Minimum Tensile Strength*, American Society for Testing Materials, West Conshohocken, PA, 1996.
- ASTM A490, *Standard Specification for Heat-Treated Steel Structural Bolts, 150 ksi Minimum Tensile Strength*, American Society for Testing Materials, West Conshohocken, PA, 1997.
- ASTM A563, *Standard Specification for Carbon and Alloy Steel Nuts*, American Society for Testing Materials, West Conshohocken, PA, 1996.
- ASTM A615, *Standard Specification for Deformed and Plain Billet-Steel Bars for Concrete Reinforcement*, American Society for Testing Materials, West Conshohocken, PA, 1996.
- ASTM A706, *Standard Specification for Low-Alloy Steel Deformed and Plain Bars for Concrete Reinforcement*, American Society for Testing Materials, West Conshohocken, PA, 1996.
- ASTM A767, *Standard Specification for Zinc-Coated (Galvanized) Steel Bars for Concrete Reinforcement*, American Society for Testing Materials, West Conshohocken, PA, 2000.
- ASTM A780-00 *Standard Practice for Repair of Damaged and Uncoated Areas of Hot-Dip Galvanized Coatings*, American Society for Testing Materials, West Conshohocken, PA, 2000.

- ASTM B695, *Standard Specification for Coatings of Zinc Mechanically Deposited on Iron and Steel*, American Society for Testing Materials, West Conshohocken, PA, 1991.
- ASTM F436, *Standard Specification for Hardened Steel Washers*, American Society for Testing Materials, West Conshohocken, PA, 1993.
- ASTM F1554, *Standard Specification for Anchor Bolts, Steel, 36,55, and 105-ksi Yield Strength*, American Society for Testing Materials, West Conshohocken, PA, 1997.
- AWS D1.1-2000, *Structural Welding Code—Steel*, American Welding Society, Miami, 2000.
- AWA D1.4, *Structural Welding Code-Reinforcing Steel*, American Welding Society, Miami, 2000.
- Building Code Requirements for Structural Concrete (ACI 318-02) and Commentary (ACI 318R-02), American Concrete Institute, Detroit, MI, 2002.
- Code of Standard Practice for Steel Buildings and Bridges*, American Institute of Steel Construction (AISC), Chicago, March 2000.
- Cook, R. A., *Behavior and Design of Ductile Multiple-Anchor Steel-to-Concrete Connections*, Thesis Dissertation, The University of Texas at Austin, Austin, TX, 1989.
- Cook, S.J., Till, R. D., and Pearson L., *Fatigue Cracking of Horizontal Gusset Plates at Arm-to-Pole Connection of Cantilever Sign Structures*, Michigan Department of Transportation, Lansing, 2000.
- DeSantis, P.V. and Haig, P.E., "Unanticipated Loading Causes Highway Sign Failure," ANSYS Conference, 1996.
- Dexter, R. J. and B. A. Kelly, "Research on Repair and Improvement Methods," *International Conference on Performance of Dynamically Loaded Welded Structures*, Proceedings of the IIW 50th Annual Assembly Conference, San Francisco, California, July 13-19, 1997, Welding Research Council, Inc., New York, pp. 273-285, 1997.
- Dexter, R. J. and Ricker, M. J., *Fatigue-Resistant Design of Cantilevered Signal, Sign, and Light Supports*, National Cooperative Highway Research Program, Final Report—NCHRP Project 10-38(2), Transportation Research Board, Washington, D.C., June 2001.
- Dexter, R.J. and Ricker, M. J., NCHRP Report 469: *Fatigue-Resistant Design of Cantilevered Signal, Sign, and Light Supports*, Transportation Research Board, National Research Council, Washington, D.C., 2002.
- Draft of ACI 349 Code Requirements for Nuclear Safety Related Concrete Structures*, American Concrete Institute, Farmington Hills, Michigan, 2000.
- Esonix UIT Specification for Fillet Welds Associated with Traffic Signal Poles, Applied Ultrasonics, Birmingham, AL.
- Federal Highway Administration, *Manual for Uniform Traffic Control Devices*, 2003.



Federal Highway Administration, "High-Strength Bolts for Bridges," FHWA Report No. FHWA-SA-91-031, Office of Technology Application, May, 1991.

*FHWA Electronic Information System Survey on Sign Structure Failures*, Spring, 1990.

Fisher, J.W., Barthelemy, B.M., Mertz, D.R., and Edinger, J.A., *NCHRP Report 227: Fatigue Behavior of Full Scale Welded Bridge Attachments*, Transportation Research Board, National Council, Washington, D.C., 1980.

Fisher, J.W., and Dexter, R.J., "Weld Improvement and Repair for Fatigue Life Extension," *Proceedings of the 12th International Conference on Offshore Mechanics and Arctic Engineering Conference (OMAE)*, 20-24 June 1993, Salama et al. Eds., ASME, Vol. III, Part B, Materials Engineering, pp. 875-882, 1993.

Fisher, J.W., Hausammann, H., Sullivan, M.D., and Pense, A.W., *NCHRP Report 206: Detection and Repair of Fatigue Damage in Welded Highway Bridges*, Transportation Research Board, National Research Council, Washington, D.C., June 1979.

Fisher, J.W. and R.J. Dexter, "Field Experience with Repair of Fatigue Cracks," *AWS/WIC International Conference on Fatigue*, Toronto, 9-10 May, pp. 45-52, 1994.

Fouad, F. H., Calvert, E. A., and Nunez, E., *NCHRP Report 411: Structural Supports for Highway Signs, Luminaires, and Traffic Signals*, Transportation Research Board, National Research Council, Washington, D.C., April 1997.

Garlich, Collins; 'Sign Structures under Watch' *Roads and Bridges Magazine*, July 1997.

Gilani, A., and Whitaker, A., "Fatigue-Life Evaluation of Steel Post Structures. I: Background and Analysis," *Journal of Structural Engineering*, March 2000.

Gregory, E. N., Slater, G., and Woodley, C.C., *NCHRP Report 321: Welded Repair of Cracks in Steel Bridge Members*, Transportation Research Board, National Research Council, Washington, D.C., October 1989.

Hartle, R. A. et al., *Bridge Inspector's Training Manual*, Report No, FHWA/PD-91/015, Federal Highway Administration, May 1995.

Holt, Thorkildsen; Publication for the 18th annual International Bridge Conference – 'Overhead Sign Structure Inspections in New York State', Pittsburgh, Pennsylvania, June 2001.

Illinois Department of Transportation, 'Sign Structure Inspection Manual', August 1985.



Jirsa, J. O., Cichy, N. T., Calzadilla, M. R., Smart, W. H., Pavlucik, M. P., and Breen, J. E., *Strength and Behavior of Bolt Installations in Concrete Piers*, Research Report 305-1F, Center for Transportation Research, The University of Texas at Austin, Austin, Texas, November 1984.

Kaczinski, M. R., Dexter, R. J., and Van Dien, J. P., *NCHRP Report 412: Fatigue-Resistant Design of Cantilevered Signal, Sign, and Light Supports*. Transportation Research Board, National Research Council, Washington, D.C., 1996.

- Kelly, B.A., Dexter, R.J., and Crompton, J., *Weld Detail Fatigue Life Improvement Techniques*, Report SR-1376, Ship Structure Committee, Washington, D.C., 1997.
- Kulak, G.L., Fisher, J.W., and Struik, J.H.A., *Guide to Design Criteria for Bolted and Riveted Joints*, Section Edition, John Wiley and Sons, New York, 1987.
- Manual of Steel Construction, Load and Resistance Factor Design*, Second Edition, American Institute of Steel Construction, Inc., Chicago, IL, 1998.
- McCrum, R., *Brief Summary of Michigan's Research Work with Anchor Bolts on Cantilevered Sign Structures*, Materials and Technology Division, Michigan Department of Transportation, Lansing, 1993.
- National Cooperative Research Council Project 350, 2001.
- New Jersey Department of Transportation Sign Structure Database, February, 2003.
- New York State Department of Transportation, 'Overhead Sign Structure Inventory and Inspections Manual, 1996.
- New York State Department of Transportation, 'Specification for Overhead Sign Structure Inspection,' October 2002.
- Specification for Structural Joints Using ASTM A325 or A490 Bolts*, Research Council For Structural Connections (RCSC), available from American Institute of Steel Construction (AISC), Chicago, 1999.
- Standard Specifications for Structural Supports for Highway Signs, Luminaires and Traffic Signals*, 4th Edition, American Association of State Highway and Transportation Officials, Washington, D.C., 2001.
- Structural Bolting Handbook, Steel Structures Technology Center, Inc., Novi, MI, 2001.
- Thorkildsen, 'Challenges to Hands On Inspection of Overhead Sign Structures', Structures Material Technology V, and NDT Conference, September 2002.
- Thorkildsen; Development of Management System for New Jersey Overhead Signs' Highway Engineering Exchange Program (HEEP), June 2003.
- Till, R.D., and Lefke, N.A., *The Relationship Between Torque, Tension, and Nut Rotation of Large Diameter Anchor Bolts*, Materials and Technology Division, Michigan Department of Transportation, Lansing, October 1994.
- 29 CFR Part 1926, *Safety Standards for Steel Erection*, Federal Register, Vol. 66, No. 12, Department of Labor, Occupational Safety and Health Administration (OSHA), 29 CFR Part 1926, Thursday, January 18, 2001.

# APPENDIX A

## EXAMPLE ELEMENT RATINGS

Foundation – S.01	
	<p><b>Figure A1</b></p> <p>Buried Foundation S.01 rate as '0', Not Applicable. However, if opposite tower foundation is exposed, rate S.01 for that foundation, state in notes buried foundation and recommend as Priority 3 to expose.</p>
	<p><b>Figure A2</b></p> <p>Deteriorated Grout Pad S.01 rate as 3, Priority 2 repair. Note also leveling nut corrosion (S.02 Item).</p>

For Element Condition Rating, Ref. Table 10.  
For Element Repair Priority, Ref. Table 11

**Anchor Rods – S.02**



**Figure A3**  
Missing Anchor Nut.  
If Span structure, rate as 2,  
Priority Repair 2. If Cantilever  
structure, rate as 3, Priority  
Repair 1.



**Figure A4**  
Anchor rods not fully engaged.  
If 80% threaded, note on report,  
rate S.02 as '1', no repair.  
  
Loose Nuts (Washers Slip)  
Less than 50% slip, rate S.02 as  
'2', Priority Repair 2.  
More than 50% slip, rate S.02  
as '2', Priority Repair 1.

**Base Plate(s) – S.03**



**Figure A5**

Steel Base Plates  
Rate as '1', Good Condition  
No weld cracks, no cracks in  
base plate, and no visible  
warping.



**Figure A6**

Buried Aluminum Base Plate  
Rate as '0', Not Applicable.  
However, if a span and opposite  
tower base plate is exposed,  
rate for that base plate, state in  
notes buried base plate and  
recommend as Priority 3 to  
expose. In any case all buried  
elements should be exposed  
per specification/plans.

**Towers – S.04**



**Figure A7**

1" to 2" Band of surface corrosion at base of post. D-meter results indicate no overall section loss.  
Rate 2, Small reduction of reliability.

However, if overall section loss in cantilever > 25%, rate 4, repair priority 1.



**Figure A8**

Dent, tear, and weld crack in first strut on tower.

Rate as 2, Repair on Priority 3 basis.

**Tower to Truss/Chord/Arm Connection(s) – S.05**



**Figure A9**

Gap between upper chord and shim pack and inadequate shim plate placement. Rate 2, Repair priority 3. Repair recommendation would be to properly place and add shim plates as necessary.



**Figure A10**

Gap between lower chord and saddle block, loose u-bolt. Rate 2, Repair as priority 3. Repair recommendation would be to add shims under saddle block to close gap at chord. The inspector would tighten the u-bolt during inspection.

**Truss Chords/Arms – S.06**



**Figure A11**

Minor surface corrosion observed on dual trussed arms.

Rate 1



**Figure A12**

Minor 4" diameter ding in lower chord. Right rear end cap missing.

Rate 2, Repair priority 3



**Truss Struts – S.07**



**Figure A13**

1.5" and 2.5" tears in strut member.

Rate 3, Repair Priority 1

Note: This strut has a cracked weld at the lower chord.



**Figure A14**

2" +/- diameter defect in aluminum strut.

Rate 1

Note: The rating of 1 is for a structure with no other deficient struts. This structure's struts are actually rated 3 due to this and other deficiencies.

**Cracks – S.08**



**Figure A15**

Weld crack in member U14 - L15 at L15. The weld crack is approximately 4" long x 1/8" wide and is propagating into the diagonal 1/2".

Rate 4, Repair priority 1

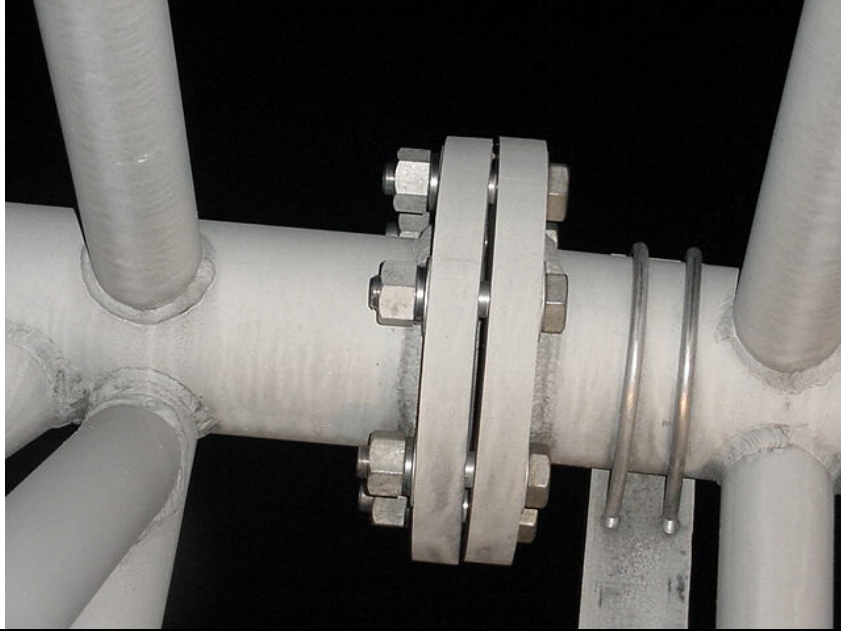

**Figure A16**

1" long weld crack at lower chord.

Rate as 3, Repair priority 1

**Chord Splice Connection(s) – S.09**



**Figure A17**

Three loose fasteners that could not be tightened by the inspector. Gap in chord splice.

Rate 3, Repair priority 2



**Figure A18**

One of several severely deteriorated splice bolts.

Rate 4, Repair priority 1

**Sign Frame and L-Brackets – S.10**



**Figure A19**

Missing one U-bolt at the lower chord to vertical sign member.

Rate 1, Repair priority 3



**Figure A20**

Sign 5 exhibits severe impact damage with missing members and hardware. Arrow shows broken bracket.

Rate 3, Repair priority 2

**Sign Panels – S.11**



**Figure A21**

Sign 5 exhibits severe impact damage with approx. 1/2 the lower section of the sign panel missing, see arrow.

Rate 3, Repair priority 2



**Figure A22**

Sign panel No. 2 was reused from old sign structure and is in fair condition.

Rate 1

**Catwalk – S.12**



**Figure A23**

Portion of catwalk over main line above lanes 1,2 and 3 exhibits severe impact damage, and has apparently been removed from this section.

Rate 4, Repair priority 3



**Figure A24**

The catwalk nosing exhibits moderate impact damage between the left most and middle light fixtures.

Rate 2, Repair priority 3

**Power and Luminaires – S.13**



**Figure A25**

Lighting and framework has been removed. A section of abandoned conduit at the center of the truss is held in place by electrical wires on one end and one u-clamp at the other.

Rate 0, Repair priority 2  
Repair priority 2 due to the inadequate attachment of the abandoned conduit.



**Figure A26**

Lighting for sign #1 is missing due to impact damage. Exposed wires present.

Rate 4, Repair priority 2

**Sign Attachment(s) – S.15**



**Figure A27**

Left rear post "No trucks in left lane" sign u-bolts are too large and sign is free to rotate.

Rate 2, Repair priority 3



**Figure A28**

"No Trucks In Left Lane" (4' x 5') sign attached to the left rear post (facing the westbound traffic) exhibits moderate impact damage.

Rate 3, Repair priority 3



**Vertical Clearance, Camber and Alignment – S.16**



**Figure A29**

Adequate camber, alignment and vertical clearance over all lanes under span.

Rate 1



**Figure A30**

Adequate camber, alignment and vertical clearance over all lanes under the cantilever.

Rate 1

**Protection – S.17**



**Figure A31**

Severe impact damage to guide rail. Damage to guide rail directly effects the protection of sign structure and motorist.

Rate 4, Repair priority 1

Note: This guide rail has since been replaced.



**Figure A32**

Eastbound Loc. Rt Side: Impact damage to guide rail 3yds east of tower. Damage doesn't significantly impact protection of structure or motorist.

Rate 2

Other – S.18



**Figure A33**

24 feet east of sign structure is an abandoned service pit with no cover.

Rate 4, Repair priority 2

The service pit/vault should be closed to protect the motorists.





**Figure A34**

RTMS traffic device attached to right rear post.

Rate 1

# APPENDIX B

## EXAMPLE INSPECTION REPORT FORMS

Prepared For:  SOUTH CAROLINA DEPT OF TRANSPORTATION	<h3 style="margin: 0;">CANTILEVER SIGN INSPECTION REPORT</h3>	Prepared By:  COLLINS ENGINEERS, INC.
<b>CONTENTS OF REPORT</b>		
<b>A. Element Rating Report</b>	<b>B. Repair Recommendations</b>	<b>C. Photographs</b>
<b>REPORT IDENTIFICATION</b>		
STRUCTURE NUMBER: <b>23043</b>		INSPECTION DATE: 9/18/01
STRUCTURE TYPE: 4-ARM CANTILEVER		
CO. NO. <b>23</b>	COUNTY NAME <b>GREENVILLE</b>	STR. TYPE <b>CA4</b>
ROAD TYPE <b>US</b>	ROUTE NO. <b>25</b>	DIRECTION <b>NB</b>
MILEPOST		
LOCATION: <b>RAMP TO I-85 NORTH</b>		
<b>STRUCTURE DESCRIPTION</b>		
SUPPORT MATERIAL: <b>STEEL-GALVANIZED</b>	INSTALLATION YEAR: <b>UNKNOWN</b>	CATWALK PRESENT: <b>YES</b>
SPAN MATERIAL: <b>STEEL-GALVANIZED</b>	GPS LATITUDE: <b>34°47'23.134"N</b>	LUMINAIRES PRESENT: <b>YES</b>
FOUNDED ON: <b>GROUND</b>	GPS LONGITUDE: <b>82°24'57.378"W</b>	MIN VERT. CLEARANCE: <b>20.1 FT</b>
BRIDGE NUMBER:	NUMBER OF SIGN PANELS: <b>2</b>	
NUMBER OF LANES UNDER STRUCTURE: <b>2</b>	RT EDGE OF ROAD TO SUPP: <b>17 FT</b>	
NUMBER OF SPLICE GROUPS: <b>1</b>	LFT EDGE OF ROAD TO SUPP: <b>N/A</b>	
SIGN DESCRIPTION: <b>1: I-85 SOUTH; ATLANTA; 1/2 MILE 2: I-85 NORTH; SPARTANBURG</b>	SIGN AREA: <b>TOTAL AREA: 275 SF 1: 13.5 FT W X 10 FT H 2: 17.5 FT W X 8 FT H</b>	
<b>STATUS</b>		
THIS REPORT IDENTIFIES DEFICIENCIES WHICH REQUIRE PROMPT CORRECTIVE ACTION: <b>NO</b>		
TYPE OF INSPECTION: <b>INITIAL</b>		
<b>INSPECTORS</b>		<b>ENGINEERING REGISTRATION NUMBER</b>
BRYAN N. JONES, P.E. (INSPECTION TEAM LEADER)		20767
JENNIFER M. MONAHAN, E.I.T. (ASSISTANT INSPECTOR)		
WILLIAM D. BARNA, E.I.T. (ASSISTANT INSPECTOR)		
QA/QC ENGINEER <b>M. L. LOVE, JR., P.E.</b>	PROFESSIONAL ENGINEER NUMBER: <b>3700</b>	
SIGNATURE: 		

## A. ELEMENT RATING REPORT

DATE INSPECTED: 9/18/01

STRUCTURE NUMBER: 23043

LOCATION: RAMP TO I-85 NORTH

No.	Element Description	Unit	Total Qty	Quantities in Condition State				
				1	2	3	4	5
S.01	FOUNDATION	EA	1	1	0	0	0	0
	Comments							
S.02	ANCHOR BOLT	EA	8	0	8	0	0	0
	Comments							
	5 ANCHOR BOLT NUTS ON THE COLUMN EXHIBITED MODERATE CORROSION. LOCK WASHERS WERE OBSERVED ON ALL OF THE ANCHOR BOLTS.							
S.03	BASE PLATE	EA	1	0	1	0	0	0
	Comments							
	THE BASE PLATE EXHIBITED LIGHT CORROSION ON APPROXIMATELY 30% OF THE SURFACE AREA.							
S.04	COLUMN SUPPORT	EA	1	1	0	0	0	0
	Comments							
S.05	COLUMN TO ARM/CHORD CONNECTION	EA	4	4	0	0	0	0
	Comments							
S.06	ARM/CHORD MEMBER	EA	4	0	4	0	0	0
	Comments							
	ALL ARM MEMBERS EXHIBITED LOSS OF GALVANIZED COATING WITH LIGHT CORROSION IN RANDOM AREAS COVERING APPROXIMATELY 40% OF THE SURFACE AREA.							
S.07	CHORD/ARM SPLICE CONNECTION	EA	4	4	0	0	0	0
	Comments							
S.08	SPAN TRUSS MEMBERS	LF	41	41	0	0	0	0
	Comments							
S.09	SIGN FRAME	EA	6	6	0	0	0	0
	Comments							
S.10	SIGN PANEL	SF	275	275	0	0	0	0
	Comments							
S.11	CATWALK	LF	35	35	0	0	0	0
	Comments							
S.12	LUMINAIRE	EA	3	0	0	0	0	3
	Comments							
	THE PHOTO SENSOR WAS INACCESSIBLE. THE LUMINAIRES COULD NOT BE TESTED.							

### CONDITION STATE DEFINITIONS:

1. Good Condition - The elements are in new or like-new condition with no significant deficiencies.
2. Satisfactory Condition - Minor damage, deterioration, or misalignment to the elements may be observed.
3. Fair Condition - Moderate damage/deterioration that does not significantly affect the element strength or integrity.
4. Poor Condition - Major or multiple defects that significantly impact the servicability or integrity of the structure.
5. Critical/Unknown Condition - Any condition where the element has failed, or failure is imminent, or unknown.

## B. REPAIR RECOMMENDATIONS

No.	Element Description	Repair Recommendations	Priority Code
S.02	ANCHOR BOLT	REMOVE THE LOCK WASHERS.	PC3
S.02	ANCHOR BOLT	THOROUGHLY CLEAN ANCHOR BOLTS AND NUTS AND APPLY A ZINC RICH COMPOUND.	PC3
S.03	BASE PLATE	THOROUGHLY CLEAN THE BASE PLATE AND APPLY A ZINC RICH COMPOUND.	PC4
S.06	ARM/CHORD MEMBER	THOROUGHLY CLEAN THE ARM MEMBERS AND APPLY A ZINC-RICH COMPOUND.	PC4
S.12	LUMINAIRE	TEST LUMINAIRE SYSTEM TO ENSURE LIGHTS WORK PROPERLY.	PC3

### DEFINITIONS:

PC: Priority Code

PC 1: High Priority: A structure, or component thereof, which is structurally unsafe: cracks in fracture critical members; cracked or broken members in danger of falling into traffic below; numerous missing or loose sign clips which may allow the sign to fall; etc.

PC 2 or 3: Middle Priority: Deficient components which do not immediately threaten the public; ruptured or cracked secondary members; one or two loose bolts at a connection or splice; minor catwalk, safety chain or handrail defects, etc.

PC 4: Low Priority: Components with minor structural deficiencies: minor loss of protective coating (galvanizing, paint); minor foundation cracks; minor cracks in secondary members; slightly displaced saddle shims; etc.



PHOTOGRAPH 1: FRONT OF STRUCTURE

E:\SCDOT\GREENVILLE\23043\23043\_01.JPG



PHOTOGRAPH 2: BACK OF STRUCTURE

E:\SCDOT\GREENVILLE\23043\23043\_02.JPG



PHOTOGRAPH 3: FOUNDATION

E:\SCDOT\GREENVILLE\23043\23043\_03.JPG



PHOTOGRAPH 4: COLUMN TO ARM CONNECTION

E:\SCDOT\GREENVILLE\23043\23043\_04.JPG



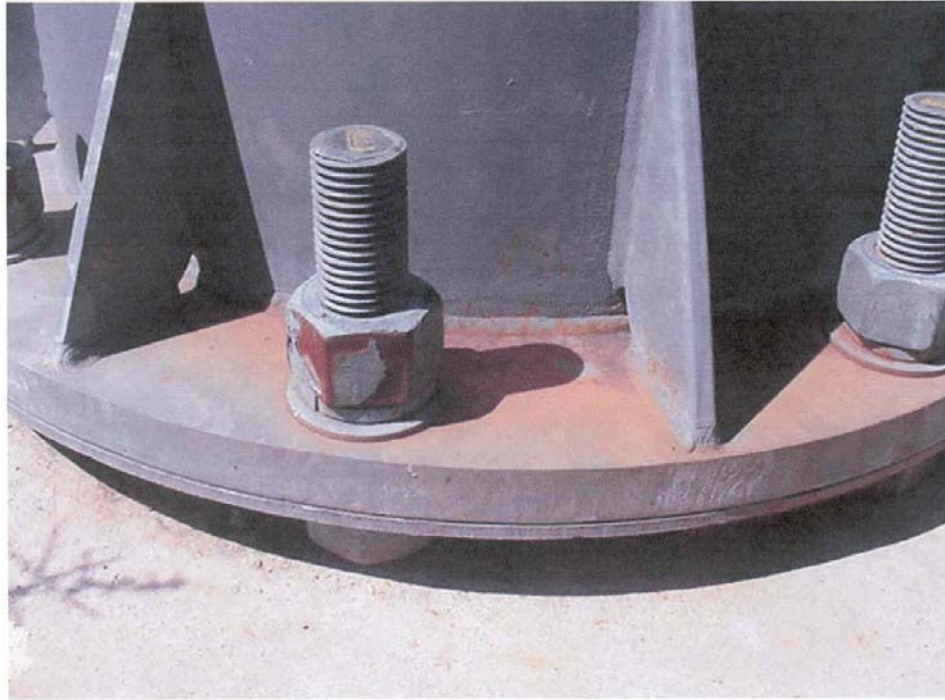

PHOTOGRAPH 5: LIGHT CORROSION ON BASE PLATE

E:\BCDOT\GREENVILLE\23043\23043\_05.JPG

PHOTOGRAPH 6:

None

Report Final Check

Name: Tara L. Keeling

Date: 5/8/02

Structure Number: 23043

**Cover Sheet (page 1)**

OK Modified

- Number of sign panels match number in sign text field and sign areas field.
- Red flag attached to green folder to indicate prompt corrective action necessary.
- M.L.'s signature and stamp is present. *Stamp*

**Element Rating Report (page 2)**

OK Modified

- Anchor Bolts: Are lockwashers present (check photos)? If yes condition state 2.
- Anchor Bolts: Loose anchor bolts are condition rating 4.
- Sign Panels: Area matches sign area on cover.
- Sign Panels: Loose clips tightened in the field are condition state 1.
- Sign Panels: Loose (not tightened in the field), missing, or broken clips are condition state 2 or 3 (if significant).
- Luminaire: Inaccessible sensor is condition state 5.
- Luminaire: Sensor was tested and lights did not work, condition state 4.

**Repair Recommendations (page 3)**

- Foundations: Grout pads are removed not repaired.
- Anchor Bolts: Remove lockwashers, PC3.
- Anchor Bolts: Loose anchor bolts are to be tightened. If more than 30% are loose, PC1, less get PC2.
- Sign Panels: Loose clips tightened in the field have no repair recommendation.
- Sign Panels: Loose (not tightened in the field), missing, or broken clips are tightened or replaced.
- Catwalk: Operable safety chains requiring repair are PC3. Inoperable or missing safety chains are PC2.
- Luminaire: Inaccessible sensors - test luminaire system to ensure lights work properly, PC3.
- Luminaire: Sensor was tested and lights did not work - Repair Lights, PC2.

**Photos (page 4 +)**

- Are all photos clear and bright. Edit in Microsoft PhotoEditor as needed. 5/7/02

**APPENDIX C**  
**SAMPLE INSPECTION REPORT**

**NEW JERSEY DEPARTMENT OF TRANSPORTATION**

**SIGN STRUCTURE EVALUATION SURVEY REPORT OF**  
**Structure Number 1414203**  
**Overhead Sign Structure at I-80 Eastbound, MP 43.90**

Parsippany-Troy Hills Township

Morris County

**CYCLE NO. 1**

**April 2002**

**Collins Engineers, Inc.**  
**573 Columbia Turnpike**  
**East Greenbush, NY 12061**

## Table of Contents

	<u>Page</u>
Letter of Transmittal	i
Title Sheet	ii
Table of Contents	iii
Summary Page	1
Summary Page (cont')	2
Comments and Comprehensive Report of Deficiencies	3, 4
Required Maintenance, Repair and Rehabilitation	5, 6
<b>IMAGES</b>	
Image 1: Visio - Front Elevation	7
Image 2: Visio - Tower Elevation	8
Image 3: Visio - Foundation and Truss Section	9
Image 4: U. T. Report	10
<b>PHOTOS</b>	
Photo 1: Front (Near Face)	11
Photo 2: Back (Far Face)	11
Photo 3: Right Tower	12
Photo 4: Left Tower	12
Photo 5: Tower to Truss Connection	13
Photo 6: Tower to Foundation Connection	13
Photo 7: Left Median/Foundation Damage	14
Photo 8: Abandoned Electrical System - A section of conduit held up by electri	14
Photo 9: Weld Pool Crack - 1/8" long and hairline (center of welds).	15
Photo 10: Lower Chord Splices at L13 - One bolt head is deteriorated.	15
Photo 11: Middle Chord Splices at M13 - Two bolt ends exhibit similar fracturin	16
Photo 12: Right foundation - Partially exposed for ultrasonic testing of the anch	16

Prepared For:  NJDOT	<b>Inspection of</b> <b>Overhead Sign Structure at I-80 Eastbound, MP 43.90</b>	<i>Inspection Date:</i> <b>4/3/2002</b>	<b>Collins Engineers, Inc.</b>
	<i>Structure Number:</i> <b>1414203</b>	<i>Inspection Cycle No:</i> <b>1</b>	<i>State Agreement No:</i> <b>2001B104</b>

**INSPECTION INFORMATION**

**Inspection Date:** 4/3/2002

**Consultant Name:** Collins Engineers, Inc.

**Inspection Type:** INITIAL      **Cycle No:** 1      **Recommended Inspection Frequency:** 60 months

**Previous Inspection Date:**

**Priority 1 or E Repair Required:** Yes

**Overall Inspection Rating:** 4 Critical

**Summary of Structure Condition:** The structure appears to be in poor condition, with severely deteriorated chord splice bolts, severely deteriorated median Jersey barrier, and three defective anchor bolts, as described herein.

**Additional Comments (if any):** A Priority 1 Repair Request was sent to DOT on 4/9/2002.

**Traffic Control Requirements for this cycle:**

Single left lane closure 4/03/02, single right 4/03/02, nighttime double left 7/10/02, nighttime double right 7/11/02.

**Inspection Team Leader:** Donald Chester, P.E.      **Initials:** DAC

**Certifying Engineer:** Eric Thorkildsen, P.E.

**NJ P.E. Number:** 41541



I certify that this report is an accurate description of the condition of the subject structure, to the extent determinable by visual inspection and testing performed.

Signature: \_\_\_\_\_ Date \_\_\_\_\_



Prepared For:  NJDOT	Inspection of <b>Overhead Sign Structure at I-80 Eastbound, MP 43.90</b>	Inspection Date: <b>4/3/2002</b>	Collins Engineers, Inc.
	Structure Number: <b>1414203</b>	Inspection Cycle No: <b>1</b>	State Agreement No: <b>2001B104</b>

**Comments and Comprehensive Report of Deficiencies**

Numerical Condition Rating Definitions	
CODE	DESCRIPTION (Note: Comment required on any item rated 2 or less)
0	Not Applicable
1	Good: Performs intended function with high degree of reliability and/or effectiveness.
2	Performs intended function with small reduction in reliability and/or effectiveness.
3	Performs intended function with significant reduction in reliability and/or effectiveness. Repair or replacement may be required.
4	Does not perform intended function at an acceptable level of reliability and/or effectiveness. Repair or replacement is required.

Rating	Component	Overall Summary of Structure Condition
<b>4</b>	<b>OVERALL RATING</b>	The structure appears to be in poor condition, with severely deteriorated chord splice bolts, severely deteriorated median Jersey barrier, and three defective anchor bolts, as described herein.

Rating	Component	Description of Deficiencies
<i>S.01</i>	Foundation	Right foundation buried . Left foundation (median barrier) moderately spalled. The spalled area extends the full length of barrier section x 5" wide x max 3" deep. See photo # 7. Top of the foundation sounds hollow.
<b>2</b>		
<i>S.02</i>	Anchor Bolts	Anchor bolt tops exposed for UT testing only. Three bolts on the right side exhibit apparent defects. Indications at 9" were observed. The three defective bolts exhibited a back wall signal at length of 70". See UT Report for specific locations.
<b>3</b>		
<i>S.03</i>	Base Plate(s)	Right side base plates are buried.
<b>1</b>		
<i>S.04</i>	Tower(s)	None
<b>1</b>		
<i>S.05</i>	Tower to Truss Chord/ Arm Connection(s)	None
<b>1</b>		
<i>S.06</i>	Truss Chords/Arm	Poor welding techniques were observed throughout the truss.
<b>1</b>		
<i>S.07</i>	Truss Struts	There is a 1/8" long hairline weld pool crack in the weld between members U13-L13 and M13-L13 at the lower chord.
<b>2</b>		

(deficiency ratings continued next page)

Prepared For:  NJDOT	Inspection of <b>Overhead Sign Structure at I-80 Eastbound, MP 43.90</b>	Inspection Date: <b>4/3/2002</b>	Collins Engineers, Inc.
	Structure Number: <b>1414203</b>	Inspection Cycle No: <b>1</b>	State Agreement No: <b>2001B104</b>

Rating	Component	Description of Deficiencies
S.08	Cracks	There is a 1/8" long hairline weld pool crack in between members U13-L13 and M13-L13 at the lower chord.
2		
S.09	Chord Splice Connection(s)	Truss splice bolts are severely deteriorated. On the right side splice, there is one defective bolt head at the lower chord and 2-fractured bolt ends at the middle chord. At the left splice, upper and lower connections have two of six bolts defective.
4		
S.10	Sign Frame and L-Brackets	None
1		
S.11	Sign Panels	None
1		
S.12	Catwalk	None
0		
S.13	Power and Luminaires	Lighting and framework has been removed. A section of abandoned conduit at the center of the truss is held in place by electrical wires on one end and one u-clamp at the other. Also, see S.18.
0		
S.14	VMS Sign	None
0		
S.15	Sign Attachment(s)	None
0		
S.16	Vertical Clearance, Camber and Alignment	None
1		
S.17	Protection	Median barrier is moderately deteriorated and exhibits exposed aggregate.
2		
S.18	Other	Electric service panel is attached to the right tower.
1		



Prepared For:  NJDOT	Inspection of <b>Overhead Sign Structure at I-80 Eastbound, MP 43.90</b>	Inspection Date: <b>4/3/2002</b>	Collins Engineers, Inc.
	Structure Number: <b>1414203</b>	Inspection Cycle No: <b>1</b>	State Agreement No: <b>2001B104</b>

**Required Maintenance, Repair, and Rehabilitation**

Numerical Repair Rating Definitions	
CODE	DESCRIPTION
0	Not Applicable (or none)
1	Priority 1 Repair Required: Items which, if not corrected immediately, threaten the viability of the structure.
2	Priority 2 Repair Item: Items which require repair on a Priority 2 basis.
3	Maintenance Item: Perform when able.

Rating	Component	Repair Description
S.01	Foundation	Excavate right foundation.
<b>3</b>		
S.02	Anchor Bolts	Excavate right foundation to expose the anchor bolts on the right side of the structure. Evaluate possible right foundation reconstruction to correct anchor bolt deficiencies..
<b>3</b>		
S.03	Base Plate(s)	Expose the base plates on the right side of the structure.
<b>3</b>		
S.04	Tower(s)	None
<b>0</b>		
S.05	Tower to Truss Chord/ Arm Connection(s)	None
<b>0</b>		
S.06	Truss Chords/Arm	None
<b>0</b>		
S.07	Truss Struts	See S.08.
<b>0</b>		
S.08	Cracks	The weld pool crack should be monitored on an annual basis if no repairs are made. Alternatively, grind out the weld pool crack to keep it from propagating.
<b>2</b>		
S.09	Chord Splice Connection(s)	Remove and replace defective splice bolts, both right lower chord and right middle splices. See photos 10 and 11.
<b>1</b>		

(repair ratings continued next page)

Prepared For:  NJDOT	Inspection of <b>Overhead Sign Structure at I-80 Eastbound, MP 43.90</b>	Inspection Date: <b>4/3/2002</b>	Collins Engineers, Inc.
	Structure Number: <b>1414203</b>	Inspection Cycle No: <b>1</b>	State Agreement No: <b>2001B104</b>

Rating	Component	Repair Description
S.10	Sign Frame and L-Brackets	None
0		
S.11	Sign Panels	None
0		
S.12	Catwalk	None
0		
S.13	Power and Luminares	Remove the abandoned section of conduit.
2		
S.14	VMS Sign	None
0		
S.15	Sign Attachment(s)	None
0		
S.16	Vertical Clearance, Camber and Alignment	None
0		
S.17	Protection	Repair or replace the median barrier.
3		
S.18	Other	None
0		

**Comments on Status of Items Previously Flagged for Maintenance**

<b>Evaluation of Previous Corrective Action</b>  Initial inspection. Previous items recommended for Priority 1 Repairs include weld cracks, deteriorated median barrier, and deteriorated splice bolts.
---

Prepared For:  NJDOT	Inspection of <b>Overhead Sign Structure at I-80 Eastbound, MP 43.90</b>	Inspection Date: <b>4/3/2002</b>	Collins Engineers, Inc.
	Structure Number: <b>1414203</b>	Inspection Cycle No: <b>1</b>	State Agreement No: <b>2001B104</b>

**Images**

<b>Image No.:</b> 31	<b>Type:</b> tif	<b>Date:</b> 20020712	<b>Path:</b> c:\njsignimages\1414203_20020712_31egn.tif
<b>Description:</b> Visio - Front Elevation			

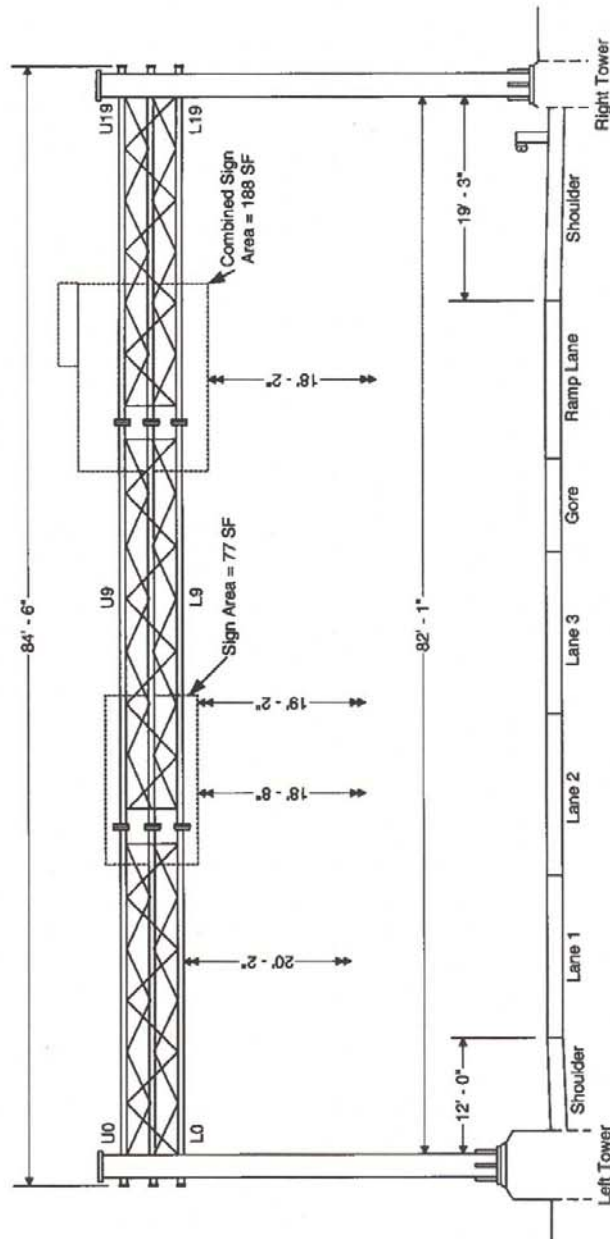

Prepared For:  NJDOT	Inspection of <b>Overhead Sign Structure at I-80 Eastbound, MP 43.90</b>	Inspection Date: <b>4/3/2002</b>	Collins Engineers, Inc.
	Structure Number: <b>1414203</b>	Inspection Cycle No: <b>1</b>	State Agreement No: <b>2001B104</b>

**Images**

<b>Image No.:</b> 32	<b>Type:</b> tif	<b>Date:</b> 20020712	<b>Path:</b> c:\njsignimages\1414203_20020712_32t.tif
<b>Description:</b> Visio - Tower Elevation			

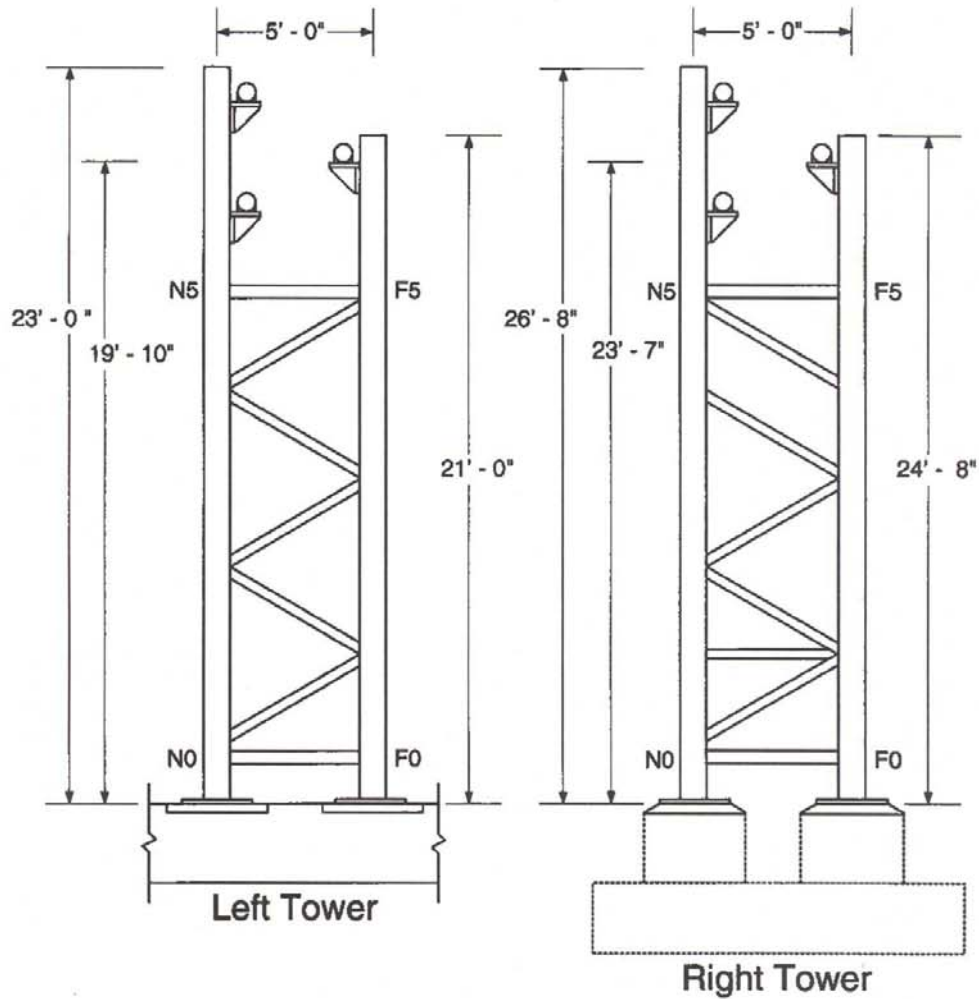

Prepared For:  NJDOT	Inspection of <b>Overhead Sign Structure at I-80 Eastbound, MP 43.90</b>	Inspection Date: <b>4/3/2002</b>	Collins Engineers, Inc.
	Structure Number: <b>1414203</b>	Inspection Cycle No: <b>1</b>	State Agreement No: <b>2001B104</b>

**Images/Photos**

<b>Image No.:</b> 33	<b>Type:</b> tif	<b>Date:</b> 20020712	<b>Path:</b> c:\njsignimages\1414203_20020712_33fgd.tif
<b>Description:</b> Visio - Foundation and Truss Section			

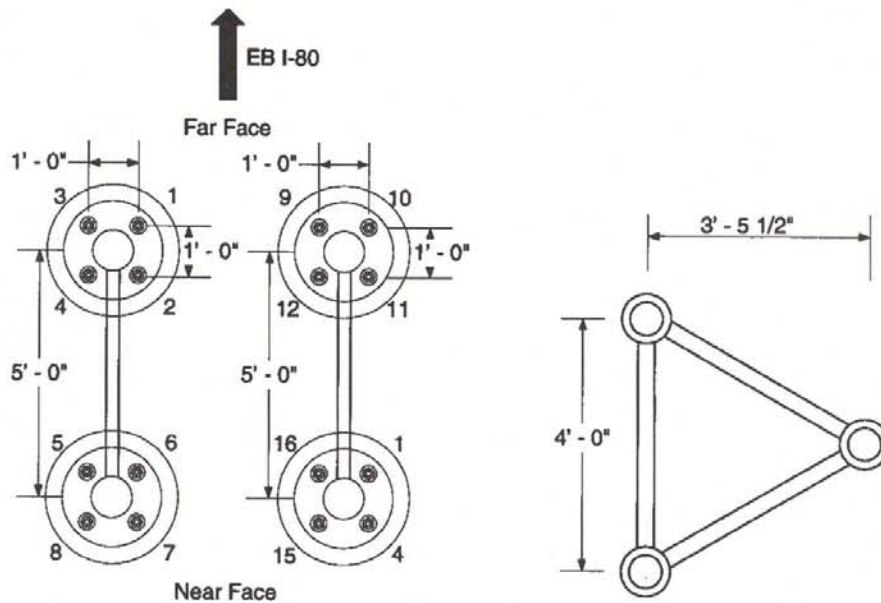

<b>Typical Tower To Foundation Connection</b>
Diameter = 1 1/2"
Bolt Length = 70"
Base Plate Thickness = 1 1/2"

<b>Typical Tri-Chord Truss Cross Section</b>
Height = 4' - 0"
Length = 3' - 5 1/2"

Prepared For:  NJDOT	Inspection of <b>Overhead Sign Structure at I-80 Eastbound, MP 43.90</b>	Inspection Date: <b>4/3/2002</b>	Collins Engineers, Inc.
	Structure Number: <b>1414203</b>	Inspection Cycle No: <b>1</b>	State Agreement No: <b>2001B104</b>

**Images**

Image No.:	34	Type:	tif	Date:	20020712	Path:	c:\njsignimages\1414203_20020712_34fxd.tif
Description: U. T. Report							



**COLLINS ENGINEERING, P.C.**  
 East Greenbush, New York

**ULTRASONIC ANCHOR BOLT INSPECTION REPORT**

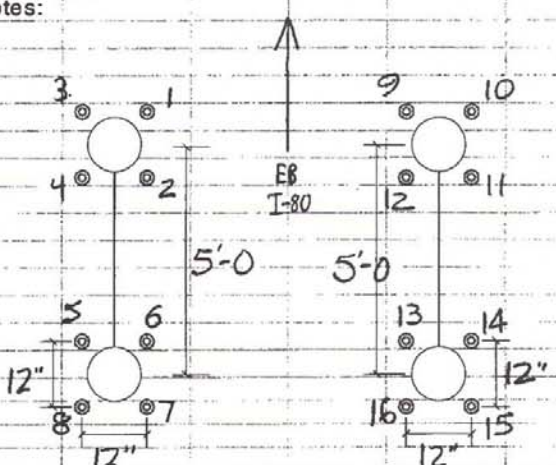
Date:	4/2/02	SIN:	1414203																																																																									
Client:	NJDOT	Procedure Identification:	Type of Machine & Ser. No.																																																																									
Diameter:	1 5/8"	Ultrasonic Anchor Bolt	Krautkramer USN 52L																																																																									
Length:	70"	Inspection Procedure	OOK 453																																																																									
Post Configuration:	Notes:																																																																											
<input type="checkbox"/> Cantilever <input type="checkbox"/> Single Post Truss <input checked="" type="checkbox"/> Dual Post Truss <input type="checkbox"/> Other:																																																																												
<table border="1" style="width: 100%; border-collapse: collapse;"> <thead> <tr> <th>Bolt No.</th> <th>Indication and Location</th> <th>Accept</th> <th>Reject</th> <th>Remarks</th> </tr> </thead> <tbody> <tr> <td>1</td> <td>NONE</td> <td style="text-align: center;">✓</td> <td></td> <td rowspan="8">STRONG SIGNALS</td> </tr> <tr> <td>2</td> <td></td> <td style="text-align: center;">✓</td> <td></td> </tr> <tr> <td>3</td> <td></td> <td style="text-align: center;">✓</td> <td></td> </tr> <tr> <td>4</td> <td></td> <td style="text-align: center;">✓</td> <td></td> </tr> <tr> <td>5</td> <td></td> <td style="text-align: center;">✓</td> <td></td> </tr> <tr> <td>6</td> <td></td> <td style="text-align: center;">✓</td> <td></td> </tr> <tr> <td>7</td> <td></td> <td style="text-align: center;">✓</td> <td></td> </tr> <tr> <td>8</td> <td></td> <td style="text-align: center;">✓</td> <td></td> </tr> <tr> <td>9</td> <td>NONE</td> <td style="text-align: center;">✓</td> <td></td> <td rowspan="2">STRONG SIGNALS SOME BACKWALL</td> </tr> <tr> <td>10</td> <td>9.55"</td> <td></td> <td style="text-align: center;">✓</td> </tr> <tr> <td>11</td> <td>9.6"</td> <td></td> <td style="text-align: center;">✓</td> </tr> <tr> <td>12</td> <td>NONE</td> <td style="text-align: center;">✓</td> <td></td> <td rowspan="4">STRONG SIGNALS</td> </tr> <tr> <td>13</td> <td>NONE</td> <td style="text-align: center;">✓</td> <td></td> </tr> <tr> <td>14</td> <td>NONE</td> <td style="text-align: center;">✓</td> <td></td> </tr> <tr> <td>15</td> <td>9.69"</td> <td></td> <td style="text-align: center;">✓</td> </tr> <tr> <td>16</td> <td>NONE</td> <td style="text-align: center;">✓</td> <td></td> <td>STRONG SIGNAL</td> </tr> </tbody> </table>				Bolt No.	Indication and Location	Accept	Reject	Remarks	1	NONE	✓		STRONG SIGNALS	2		✓		3		✓		4		✓		5		✓		6		✓		7		✓		8		✓		9	NONE	✓		STRONG SIGNALS SOME BACKWALL	10	9.55"		✓	11	9.6"		✓	12	NONE	✓		STRONG SIGNALS	13	NONE	✓		14	NONE	✓		15	9.69"		✓	16	NONE	✓		STRONG SIGNAL
Bolt No.	Indication and Location	Accept	Reject	Remarks																																																																								
1	NONE	✓		STRONG SIGNALS																																																																								
2		✓																																																																										
3		✓																																																																										
4		✓																																																																										
5		✓																																																																										
6		✓																																																																										
7		✓																																																																										
8		✓																																																																										
9	NONE	✓		STRONG SIGNALS SOME BACKWALL																																																																								
10	9.55"		✓																																																																									
11	9.6"		✓																																																																									
12	NONE	✓		STRONG SIGNALS																																																																								
13	NONE	✓																																																																										
14	NONE	✓																																																																										
15	9.69"		✓																																																																									
16	NONE	✓		STRONG SIGNAL																																																																								
Technician: <i>Don Foster</i>		ASNT Level: <i>II</i>																																																																										

Prepared For:  NJDOT	Inspection of <b>Overhead Sign Structure at I-80 Eastbound, MP 43.90</b>	Inspection Date: <b>4/3/2002</b>	Collins Engineers, Inc.
	Structure Number: <b>1414203</b>	Inspection Cycle No: <b>1</b>	State Agreement No: <b>2001B104</b>

**Photos**

<b>Image No.:</b> 01	<b>Type:</b> jpg	<b>Date:</b> 20010207	<b>Path:</b> c:\njsignimages\1414203_20010207_01egn.jpg
<b>Description:</b> Front (Near Face)			



<b>Image No.:</b> 02	<b>Type:</b> jpg	<b>Date:</b> 20020403	<b>Path:</b> c:\njsignimages\1414203_20020403_02egf.jpg
<b>Description:</b> Back (Far Face)			



Prepared For:  NJDOT	Inspection of <b>Overhead Sign Structure at I-80 Eastbound, MP 43.90</b>	Inspection Date: <b>4/3/2002</b>	Collins Engineers, Inc.
	Structure Number: <b>1414203</b>	Inspection Cycle No: <b>1</b>	State Agreement No: <b>2001B104</b>

**Photos**

<b>Image No.:</b> 03	<b>Type:</b> jpg	<b>Date:</b> 20020403	<b>Path:</b> c:\njsignimages\1414203_20020403_03tr.jpg
<b>Description:</b> Right Tower			



<b>Image No.:</b> 04	<b>Type:</b> jpg	<b>Date:</b> 20020403	<b>Path:</b> c:\njsignimages\1414203_20020403_04tl.jpg
<b>Description:</b> Left Tower			





Prepared For:  NJDOT	Inspection of <b>Overhead Sign Structure at I-80 Eastbound, MP 43.90</b>	Inspection Date: <b>4/3/2002</b>	Collins Engineers, Inc.
	Structure Number: <b>1414203</b>	Inspection Cycle No: <b>1</b>	State Agreement No: <b>2001B104</b>

**Photos**

<b>Image No.:</b> 05	<b>Type:</b> jpg	<b>Date:</b> 20020403	<b>Path:</b> c:\nj\signimages\1414203_20020403_05tgu.jpg
<b>Description:</b> Tower to Truss Connection			



<b>Image No.:</b> 06	<b>Type:</b> jpg	<b>Date:</b> 20020403	<b>Path:</b> c:\nj\signimages\1414203_20020403_06fgn.jpg
<b>Description:</b> Tower to Foundation Connection			



Prepared For:  NJDOT	<b>Inspection of</b> <b>Overhead Sign Structure at I-80 Eastbound, MP 43.90</b>	Inspection Date: <b>4/3/2002</b>	<b>Collins Engineers, Inc.</b>
	Structure Number: <b>1414203</b>	Inspection Cycle No: <b>1</b>	State Agreement No: <b>2001B104</b>

**Photos**

<b>Image No.:</b> 07	<b>Type:</b> jpg	<b>Date:</b> 20020403	<b>Path:</b> c:\njsignimages\1414203_20020403_07pdl.jpg
<b>Description:</b> Left Median/Foundation Damage			



<b>Image No.:</b> 08	<b>Type:</b> jpg	<b>Date:</b> 20020403	<b>Path:</b> c:\njsignimages\1414203_20020403_08sdf.jpg
<b>Description:</b> Abandoned Electrical System - A section of conduit held up by electrical wires.			



Prepared For:  NJDOT	Inspection of <b>Overhead Sign Structure at I-80 Eastbound, MP 43.90</b>	Inspection Date: <b>4/3/2002</b>	Collins Engineers, Inc.
	Structure Number: <b>1414203</b>	Inspection Cycle No: <b>1</b>	State Agreement No: <b>2001B104</b>

**Photos**

<b>Image No.:</b> 09	<b>Type:</b> jpg	<b>Date:</b> 20020404	<b>Path:</b> c:\njsignimages\1414203_20020404_09gdd.jpg
<b>Description:</b> Weld Pool Crack - 1/8" long and hairline (center of welds).			



<b>Image No.:</b> 10	<b>Type:</b> jpg	<b>Date:</b> 20020403	<b>Path:</b> c:\njsignimages\1414203_20020403_10bdu.jpg
<b>Description:</b> Lower Chord Splices at L13 - One bolt head is deteriorated.			



Prepared For:  NJDOT	<b>Inspection of</b> <b>Overhead Sign Structure at I-80 Eastbound, MP 43.90</b>	<i>Inspection Date:</i> <b>4/3/2002</b>	<b>Collins Engineers, Inc.</b>
	<i>Structure Number:</i> <b>1414203</b>	<i>Inspection Cycle No:</i> <b>1</b>	<i>State Agreement No:</i> <b>2001B104</b>

**Photos**

<b>Image No.:</b> 11	<b>Type:</b> jpg	<b>Date:</b> 20020403	<b>Path:</b> c:\njsignimages\1414203_20020403_11bdd.jpg
<b>Description:</b> Middle Chord Splices at M13 - Two bolt ends exhibit similar fracturing.			



<b>Image No.:</b> 12	<b>Type:</b> jpg	<b>Date:</b> 20020402	<b>Path:</b> c:\njsignimages\1414203_20020402_12fdr.jpg
<b>Description:</b> Right foundation - Partially exposed for ultrasonic testing of the anchor bolts.			



## APPENDIX D

# ULTRASONIC ANCHOR INSPECTION PROCEDURE

FISH INSPECTION AND TESTING LLC

### ULTRASONIC ANCHOR BOLT INSPECTION PROCEDURE

#### Scope

This procedure when specified shall be the method used to ultrasonically examine bolts to locate fatigue cracks perpendicular to bolt length.

#### Reference Documents

ASME Section V  
American Welding Society D1.1  
Qualification and Certification of NDT Personnel  
Control of Measuring and Test Equipment

#### Personnel Requirements

The personnel implementing this procedure shall be certified in accordance with Fish Inspection and Testing LLC NDE Quality Assurance Manual "Qualification and Certification of NDT Personnel," as either Level II or III to evaluate results, or Level I to perform the operational portion of the examination and record data while under the direct supervision of a Level II or III.

#### Equipment and Material

1. Equipment and materials used to implement this procedure will be calibrated and certified in accordance with Fish Inspection and Testing LLC NDE Quality Assurance Manual "Control of Measuring and Testing Equipment." A copy of the equipment and material certifications will be available at the request of the client.

##### A. Instrumentation

The ultrasonic instrument shall be a Pulse-Echo type unit equipped with an A scan presentation and capable of generating frequencies over the range of 1 MHz to 5 MHz. The instrument will also be equipped with a calibrated attenuator in one (1) or two (2) db steps with an accuracy over its range of  $\pm 2$ db.

##### B. Transducers

1. Search units should be single element transducers.
2. Transducers may be 1 MHz to 5 MHz in frequency.
3. Search unit crystals may be 3/8 inch to 1/2inch in diameter.

C. Calibration blocks shall be either International Institute of Welding (IIW) Type I or Type II or Distance and Sensitivity Calibration Block (DSC) used in conjunction with calibration standards of Paragraph D. At the option of the client, specific calibration standards can be prepared at their discretion to verify adequacy of this procedure.

D. Calibration Standards

Calibration standards shall be made out of the same or similar material as the bolts being examined. The standard shall be made of material free of indications that may affect calibration. The optional standards should be of the same diameter and length and material type as the bolts being examined. The standards shall be machined with a 1/8 inch deep saw cut below the root of the threads. The saw cut shall be located at 2 inches, 4 inches, 6 inches, and 8 inches from the threaded end of the bolt. The saw cut shall be located perpendicular to the end of the bolt. The end of the bolt shall be flat and smooth as to not interfere with free movement of the search unit. The saw cuts shall be located in different quadrants so they do not mask the notch below.

Prerequisites, Precautions and Limitations

- A. The surface of the test material shall be flat, smooth and in its final condition prior to the examination. This may require the use of hand grinders to facilitate search unit movement.
- B. The same equipment used for calibration shall be the same as used for examination purposes. This includes the ultrasonic instrument, cables, search unit and couplant. Any change in this equipment requires recalibration.
- C. This procedure may be used for 1/2 inch to 3-inch diameter bolts. The area of interest shall be the first ten inches. If the area past the first ten inches is to be examined, further evaluation should be performed before using this procedure with special attention to beam spread and mode conversion. This evaluation will be performed by Fish Inspection and Testing LLC level ultrasonic examiner and results approved by the client prior to any examinations.

## Procedure Requirements

- A. The surface to be examined shall be smooth and free of roughness or other conditions that would interfere with free movement of the search unit or impair the transmission of ultrasonic waves. The nut should be fully threaded past the end of the bolt so as not to interfere with search unit scanning area.
- B. Examination Calibration
  - 1. Calibration shall include the complete ultrasonic examination system. Any changes in search units, shoes, couplant, cables, instruments, or recording devices will result in a calibration check. The initial calibration must take place on the IIW, DSC or optional calibration standards.
  - 2. The CRT screen shall be calibrated for a 10-inch screen range using the approved calibration blocks in Paragraph 1. Then place the search unit on the threaded end of the calibration standard. Locate the closest or 2-inch saw cut. Adjust the amplitude to 90 percent. Record the instrument setting on the examination sheet. Next, locate the 4-inch saw cut. Note the peak amplitude on the examination sheet. Also, mark the screen with an erasable marker. Do the same for the remaining two saw cuts. Next, connect the marks of the screen to create a Distance Amplitude Curve (DAC).
- C. Straight Beam Examination of Bolts
  - 1. With CRT screen calibrated according to Paragraph B.2. Position the search unit on the bolt to be examined. The entire surface of the bolt shall be scanned at 12Db over reference.
  - 2. Accept/reject standards – any indication within 20 percent DAC at reference level, the indication shall be recorded. If any indications are found to exceed DAC at reference level, the bolt shall be considered reject and should be recorded on the examination sheet. If no indications are found, the bolt shall be considered acceptable.

D. Length Measurement

1. Anchor bolt length may be verified if plans showing anchor bolt details are available. Caution: If anchor bolts have a bent hook at ends, length measurement may not be possible.
2. Calibrate the instrument for screen range required to analyze full bolt length using the AWS IIW block. Take measurements of the total bolt length and record it on the examination sheet for each of the bolts.

E. System Calibration Check

1. A system calibration check which verifies the instruments' sensitivity and sweep range calibration shall be performed at the start and finish of each examination or with any change of examination personnel or at least every 4 hours during the examination.
2. System recalibration shall take place when one or more of the following occur.
  - a. Any change of examination personnel.
  - b. Any change of examination equipment cables, transducers or instruments.
  - c. Any change of interruption in the power supply.
  - d. When the operator doubts the validity of the calibration.

F. Post Cleaning

1. All excess couplant shall be removed after completing examination.
2. If original coating was removed for examination, examination area shall be recoated with a rust inhibitive coating approved by the client.



#### G. Corrective Actions

1. If any point on the DAC curve has decreased 20% of 2db of its amplitude, all data sheets since the last calibration will be marked void. A new calibration sheet shall be completed and all areas examined since the last calibration shall be re-examined.
2. If any point on DAC curve increases 20% or 2 db of its amplitude, the same corrective action as Paragraph G.1 shall be taken.
3. If any point on the DAC curve moves more than 10% of the horizontal sweep, all data taken since the last calibration shall be corrected.

#### H. Evaluation and Recording of Results

1. All defects or discontinuities revealed by the examination will be evaluated in accordance with Paragraph C2 and reported to the client.

**Ultrasonic Testing of Anchor Bolts**  
**Distance Amplitude Correction Method (DAC)**

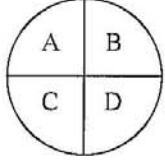
General Information			
Structure ID:	Project No:	Report No:	Inspection Date & Time:
Testing Equipment Information			
UT Unit Make & Model:	Serial No:	Couplant Manf. & Grade:	
Search Unit Manf., Dia., & Frequency:		Search Unit Beam Spread ( $\sin \theta = 1.22 \lambda / d$ ):	
Search Unit Near Zone ( $L = D^2 / 4 \lambda$ ):	Smallest Detectable Defect ( $0.5 \lambda$ ):	Typical Anchor Bolt layout Sketch	
Calibration Information		<ul style="list-style-type: none"> <li>Number Anchor Bolts clockwise-designate location of starting point</li> <li>Divide each anchor bolt into 4 quadrants(A,B,C,D)and report each quadrant in the evaluation</li> </ul> <div style="text-align: center; margin-top: 10px;">  </div>	
Calibration Standard:			
Calibration Settings	% of Screen Height		
Amplitude of Notch at 2"			
Amplitude of Notch at 4"			
Amplitude of Notch at 6"			
Amplitude of Notch at 8"			
Visual Anchor Bolt Conditions:			

Ultrasonic Testing Evaluation							
Anchor Bolt Number	Diameter	Measured Length	Evaluation ( <i>N.S.</i> = <i>No Significant Indication</i> )				Remarks
			A	B	C	D	

Inspector Name (Print): \_\_\_\_\_

Inspector Signature: \_\_\_\_\_ ASNT Level: \_\_\_\_\_ Date: \_\_\_\_\_