

NDOT Pavement Design Manual



2018



NEBRASKA

Good Life. Great Journey.

DEPARTMENT OF TRANSPORTATION

**Pavement Design
Section
Materials and Research**

Table of Contents

Chapter 1: Pavement Design Reference Materials	5
1.1 Map of NDOT Districts w/ Contacts	6
Chapter 2: Pavement Design Overview	7
2.1 Pavement Determination Process	7
2.2 Pavement Histogram Example	8
2.3 Abbreviations & Definitions	9
2.4 Design Input Templates.....	11
2.4a DARWIN Rigid Design Inputs.....	11
2.4b DARWIN Flexible Design Inputs	12
2.4c DARWIN Unbonded Concrete Overlay of Composite or Rigid with an Interlayer Design Inputs.....	13
2.4d DARWIN Unbonded Concrete Overlay of Asphalt Design Inputs	14
2.5 Average Initial Truck Factors	16
2.5a NE National Functional Classification Map	17
2.6 Design Standards Documentation	18
2.6a Proposed update to RDM.....	18
2.6b Beveled Edge & Rumble Strips	20
2.7 Local Projects Pavement Design Guidance	21
2.7a Local Projects Pavement Determination Data Sheet	24
2.7b Local Projects Preliminary and Final Checklists	27
Chapter 3: Pavement Design Guidance	30
3.1 Hot Mix Asphalt Guidance.....	30
3.2 Current Hot Mix Asphalt Designs	32
3.3 Relinquishment Policy	33
3.4 PCC Pavement Design Guidance.....	34
3.5 Road Damage vs. Axle Loading Comparison	35
3.6 Vehicle Classifications	37
3.7 Layer Coefficients for Design.....	43
3.8 Pavement Condition Definitions	44
Chapter 4: Pavement Strategy Summary	45
4.1 Flexible Pavements.....	45
4.2 Rigid Pavements.....	48
4.3 Stabilized Subgrades.....	50
Chapter 5: Subgrade.....	51

5.1	Calculating Nebraska Group Index (NGI)	51
5.2	Resilient Modulus of Soils Based on NGI	52
5.3	Subgrade Stabilization Agent Selection	54
5.4	Plasticity Index Description	55
5.5	Soil Identification and Description	56
5.6	Current NDOT Compaction Requirements	62
Chapter 6: Concrete.....		63
6.1	Current Concrete Mixes	63
6.2	Historical Concrete Mixes	64
6.3	Evaluation of Potential ASR	66
6.4	Joint Design Example	71
6.5	Area of Steel Calculation	72
6.6	Area of Steel Calculation - Example: Interstate Lanes + Shoulder.....	74
Chapter 7: Asphalt and Asphalt Binders.....		75
7.1	Historical Asphalt Mixes	75
7.2	Asphalt Binders/Emulsions	79
Chapter 8: Maintenance using Hot Pour Sealants.....		80
Chapter 9: Cost and Quantity Estimates		82
9.1	Estimated Costs Per Mile (Asphalt)	82
9.2	Preventative Maintenance Costs Per Mile	85
9.3	Concrete Repair Costs	86
9.4	Estimating Quantities Worksheet.....	88
Chapter 10: Laboratory Procedures - Testing and Sample Preparation		97
Chapter 11: History of NDOT Asphalt		99
Chapter 12: Project Numbering		109
12.1	Project Prefixes	110
12.2	Highway Numbers by Direction	112
12.3	Non-Interstate Zone Map.....	113
12.4	Interstate Zones.....	114
12.5	Interstate Zone Map	115
Chapter 13: 28 Ft Surfaced Top		116

Chapter 1: Pavement Design Reference Materials

- 2011 Pavement Design Workshop Presentation (Power Point)
<https://dot.nebraska.gov/business-center/materials/mr-division-presentations/>
- AASHTO Guide For Design of Pavement Structures 1993 (Referenced as **AASHTO** below, may be purchased on-line.)
- Standard Specifications for Highway Construction (2017)
<https://dot.nebraska.gov/media/10343/2017-specbook.pdf>
- Nebraska Department of Roadway Design Manual (**NDOT RDM**)
<https://dot.nebraska.gov/business-center/design-consultant/rd-manuals/>
- Nebraska Department of Transportation Pavement Design Manual (**NDOT PDM**)
<https://dot.nebraska.gov/business-center/materials/>

Note: NDOT utilizes the 1993 *AASHTO Guide for Design of Pavement Structures* and Part II Supplement as a basis for pavement design. The software version, DARWIN 3.1 is also used extensively. This manual is a compilation of NDOT design practices, procedures, materials data, etc. used on a daily basis in addition to the AASHTO manual.

1.1 Map of NDOT Districts w/ Contacts

Date: 11/2018

Source: <https://dot.nebraska.gov/media/1283/district-map-with-contacts.pdf>

Nebraska Department of Transportation District Engineers

Thomas Goodbarn District 1 Lincoln 402-471-0850 FAX: 402-471-3401	Timothy W. Weander District 2 Omaha 402-595-2534 FAX: 402-595-1720	Kevin Domogalla District 3 Norfolk 402-370-3470 FAX: 402-370-3473	Wesley Wahlgren District 4 Grand Island 308-385-6265 FAX: 308-385-6269	Doug Hoewet District 5 Gering 308-436-6587 FAX: 308-633-6614	Gary Thayer District 6 North Platte 308-535-8031 FAX: 308-535-8034	Kurt Vosburg District 7 McCook 308-345-8490 FAX: 308-345-8492	Mark Kovar District 8 Ainsworth 402-387-2471 FAX: 402-387-1498
--	---	--	---	---	---	--	---

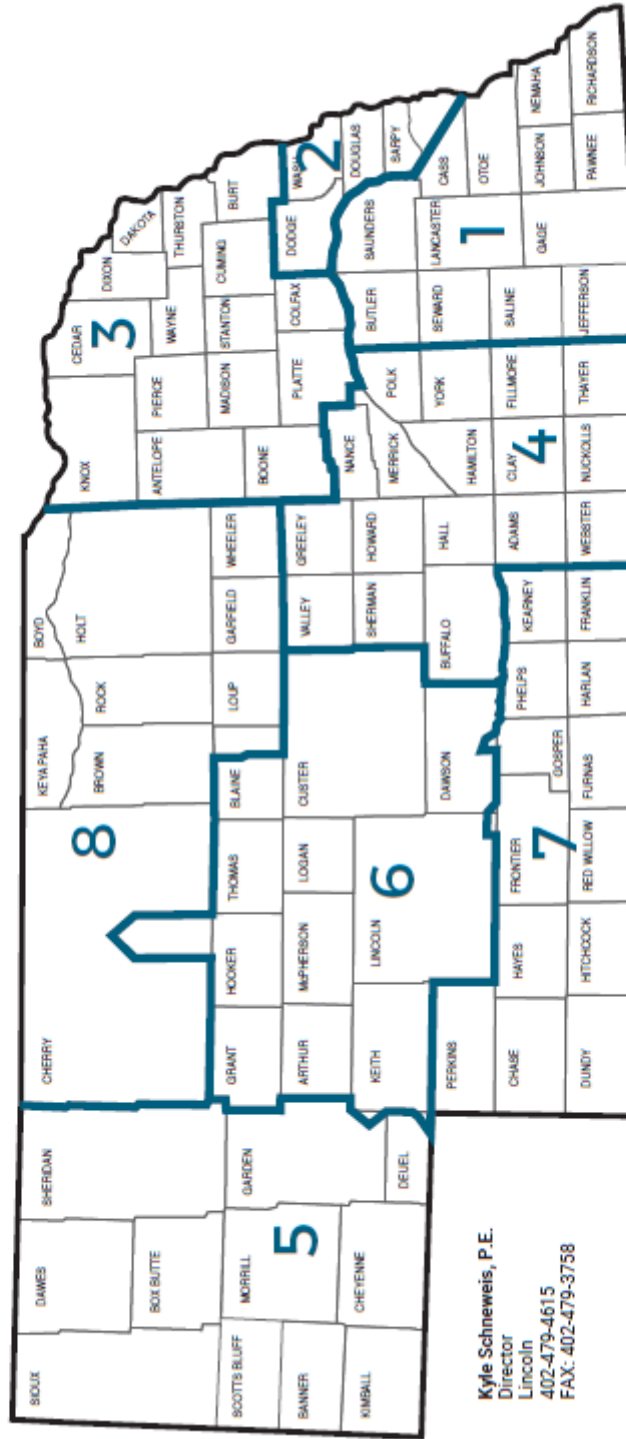

Kyle Schneeweis, P.E.
Director
Lincoln
402-479-4615
FAX: 402-479-3758

Nebraska Highway Commission

Mary K. Gerdes District 1 Johnson 402-868-3625	E.J. Militti, Jr. District 2 Omaha 402-399-1513 FAX: 402-399-6336	David E. Copple District 3 Norfolk 402-371-4300 FAX: 402-379-3700	James H. Kindig District 4 Kearney 402-752-3201	Doug Leafgreen District 5 Gering 308-631-4471	Jim Hawks District 6 North Platte 308-535-6724	Greg Wolford District 7 McCook 308-345-2370 FAX: 308-345-2371	Jerome A. Fagerland District 8 Atkinson 402-340-7080
--	--	--	---	---	--	--	--

Chapter 2: Pavement Design Overview

2.1 Pavement Determination Process

Date: Revised 2018
Source: Barrett

During the design life of a project there are five activities completed by Pavement Design. All activities, except the Verification, are forwarded to the District Engineer for concurrence.

1. **Scoping Pavement Determination:** The pavement strategy uploaded to Agility (Programming Workflow which routes a project through different Divisions, including Roadway Design, Bridge, Pavement, etc...) and is incorporated into the DR-73 scoping document. The Scoping Pavement Determination is not posted to On-Base. E-mail to DE for approval.
2. **Clarity Task 5258 (Pavement Determination):** The pavement strategy is created after the DR-73 is finalized. The Pavement Determination is posted to On-Base. Email distribution for this task includes: District Engineer, Project Scheduling/Program Manager, Assigned Roadway Designer, Roadway Design Manager, Roadway Design Section Head, and Pavement Design Staff.
3. **Clarity Task 5364 (Pavement Determination Review):** The Pavement Determination Review is intended to incorporate additions and revisions often as a result of core review and Roadway Design project development. The Pavement Determination Review is posted to On-Base and has the same distribution as Clarity Task 5258.
4. **Clarity Task 5406 (Final Pavement Determination):** The Final Pavement Determination is completed after reviewing cores and FWD results. The Final Pavement Determination is routed to the Pavement Design Engineer, the M&R Engineer, and District Engineer through Pavement Design workflow.
5. **Clarity Task 5555 (Pavement Determination Verification):** The Pavement Determination Verification is a confirmation that the Final Pavement Determination is current. This verification step takes place just prior to PS&E turn-in. There is no distribution or document posting to On-Base.

2.2 Pavement Histogram Example

Date: 2018
Source: Pavement Design Section

A Pavement Histogram is created in the research and scoping phase of a project. It is posted to On-Base as a reference during Design. At Letting a copy is posted to Bidex for informational purposes only.

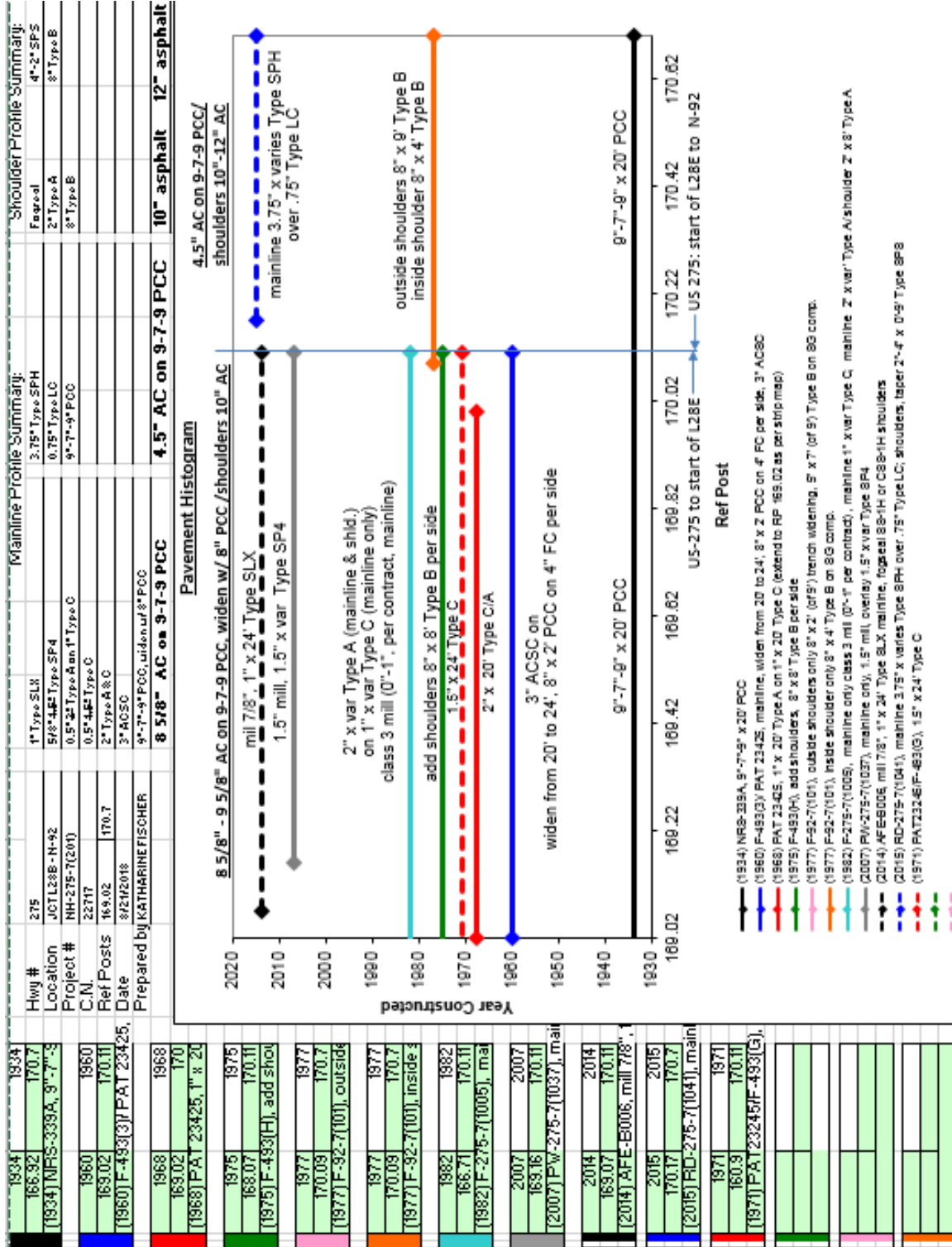

2.3 Abbreviations & Definitions

Date: Updated 9/2018

Source: Barrett

Abbreviations

AC – Armor Coat

ACSC - Asphaltic Concrete Surface Course

ADT – Average Daily Traffic

ADTT - Average Daily Truck Traffic

ASR – Alkali-Silica Reaction

BSBC – Bituminous Sand Base Course OR Bit. Stabilized B.C.

BM - Bituminous Material

BMSC – Bituminous Material Surface Course

BR – Bridge

CAA – Coarse Aggregate Angularity

CIR – Cold In-place Recycling

CONC - Concrete Pavement

CRCP – Continuously Reinforced Concrete Pavement

CSS – Cationic Slow Set

ESAL – Equivalent Single Axle Load

FAA – Fine Aggregate Angularity

FC – Foundation Course

FWD – Falling Weight Deflectometer

GR - Grading

G.R. – Guard Rail

HIR – Hot in Place Recycle

HLSS – Hydrated Lime Slurry Stabilization

HMA – Hot Mix Asphalt

JRCP – Jointed Reinforced Concrete Pavement

JPCP – Jointed Plain Concrete Pavement

M_R – Resilient Modulus

PC – Prime Coat

PCC – Portland Cement Concrete

9”-7”-9” Concrete. - Parabolically Crowned Concrete with 7” thickness at center and 9” thickness at edge

PDM – Pavement Design Manual

RAP – Recycled Asphalt Pavement (millings)

RAS – Recycled Asphalt Shingles

RDM – Roadway Design Manual

SABC - Soil Aggregate Base Course

SSBC - Stabilized Sand Base course OR Stabilized Soil Base Course

SSHC – State Specification for Highway Construction (2017 latest version)

TSB – Tar Stabilized Base

Definitions

Subgrade Preparation – Topsoil removed and top 6” of soil compacted to Optimal Moisture and Stiffness.

Stabilized Subgrade – Lime, Fly Ash, Cement, Cement Kiln Dust, etc. added to upper 8” of cohesive soil to Optimal Moisture and Stiffness.

Subgrade Stabilization – Soil Binder added to upper 6” of granular.

Aggregate Foundation Course – clean, crushed aggregate layer, gradation and angularity requirements

Aggregate Foundation Course with binder – gravel, sand and soil binder. Older Specifications refer to this as Aggregate Foundation course (Regular)

Bituminous Foundation Course – Millings

Bit Sand Base Course – Oil mixed with granular material, historically used in the western half of the state, (low truck count hways.) Sec. 509

Soil Aggregate Base Course – Defined in older Spec. books, no longer in Current Spec. Book.

Existing Stabilized Fill – Sand + Gravel + Cohesive Soil (10-15%)

2.4 Design Input Templates

2.4a DARWIN Rigid Design Inputs

Date: Reviewed 2018

Source: Pavement Design Section

Description:

- Project Number
- Project Title
- Control Number
- Designer
- Date

The following inputs are values typically used by NDOT based on NDOT testing and design practices. Values may be adjusted as needed based on specific project details and in accordance with the 1993 *AASHTO Guide for Design of Pavement Structures*.

18-kip ESALs Over Initial Performance Period Calculation (Simple Tab):

- Performance Period (years) ----- 35
- Two-way Daily Traffic (ADT) ----- Current ADT
- Number of Lanes in Design Direction ----- Proposed Design
- % of All Trucks in Design Lane ----- 100 % (2-lanes) [II-9](#)
80 % (Expressway and Interstate)
60 % (6-lane, Range)
- % Trucks in Design Direction ----- 50 % [II-9](#)
- % Heavy Trucks (of ADT) ----- Current % of ADT
- Average Initial Truck Factor (ESALs/Truck) ----- See Average Initial Truck Factors table
- Annual Truck Factor Growth Rate (%) ----- 0 %
- Annual Truck Volume Growth Rate (%) ----- $(\text{Future TADT}/\text{Present TADT})^{(1/\text{yrs})} - 1) \times 100$
- Growth Rate ----- Compound
- Initial Serviceability ----- 4.4 [II-10](#)
- Terminal Serviceability ----- 3.0 (Interstate System)
2.5 (All other Highway Systems)
- 28-Day Mean PCC Modulus of Rupture ----- 668 psi
- 28-Day Mean Elastic Modulus of Slab ----- 3,860,000 psi

Mean Effective k-value:

Seasons:	*Roadbed Soil Resilient Modulus (psi):	Base Elastic Modulus (psi):
• Frozen (Dec – Feb)	20,000	22,000
• Wet (Mar-May)	Soils Data. See Chapter 5 for M _R based on NGI	“
• Optimum (Jun-Aug)	“	“
• Dry (Sept-Nov)	“	“
	*May use 30,000 psi year round for lime, fly ash, or cement stabilized soils.	
• Base Type -----	Foundation Course	
• Base Thickness -----	4” (usually)	
• Depth to Bedrock -----	20 ft II-37	
• Projected Slab Thickness -----	10 in.	
• Loss of Support -----	1 (FC or Stab SG), 2 (SG Prep) II-27	
• Reliability Level (%) -----	85 (Interstate System) II-9 80 (Expressway System) 75 (Highways w/Future ADT over 3000) 70 (Highways w/Future ADT under 3000)	
• Overall Standard Deviation -----	0.35 II-10	
• Load Transfer Coefficient, J -----	3.0 (Doweled conc. w/tied conc. shlds.) II-26 3.1 (Doweled conc., 30’ top) 3.2 (Doweled conc. w/asph. or no shlds.) 3.6 (Non-doweled conc. w/tied conc. shlds.) 4.1 (Non-doweled conc. w/asph. or no shlds.)	
• Overall Drainage Coefficient, Cd -----	1 II-26	

2.4b DARWIN Flexible Design Inputs

Date: Reviewed 2018

Source: Pavement Design Section

Description:

- Project Number
- Project Title
- Control Number
- Designer
- Date

The following inputs are values typically used by NDOT based on NDOT testing and design practices. Values may be adjusted as needed based on specific project details and in accordance with the 1993 *AASHTO Guide for Design of Pavement Structures*.

18-kip ESALs Over Initial Performance Period Calculation (Simple Tab):

- Performance Period (New Build) ----- 20 yrs
- Performance Period (Overlay Design Module Only)
 - 4" HMA over PCC ----- 15 yrs
 - HLSS, Fly Ash, & CIR w/ 3" HMA, Mill 4"/Fill 4"-- 15 yrs
- Two-way Daily Traffic (ADT) ----- Current ADT
- Number of Lanes in Design Direction ----- Proposed Design
- % of All Trucks in Design Lane -----
 - 100 % (2-lanes) *II-9*
 - 80 % (Expressway and Interstate)
 - 60 % (6-lane)
- % Trucks in Design Direction ----- 50 % (always) *II-9*
- % Heavy Trucks (of ADT) ----- Current % of ADT
- Average Initial Truck Factor (ESALs/Truck) ----- See Average Initial Truck Factors table
- Annual Truck Factor Growth Rate (%) ----- 0 %
- Annual Truck Volume Growth Rate (%) ----- $((\text{Future TADT}/\text{Present TADT})^{(1/\text{yrs})} - 1) \times 100$
- Growth Rate ----- Compound
- Initial Serviceability ----- 4.4 *II-10*
- Terminal Serviceability -----
 - 3.0 (Interstate System)
 - 2.5 (All other Highway Systems)
- Reliability Level -----
 - 85 (Interstate System) *II-9*
 - 80 (Expressway System)
 - 75 (Highways w/Future ADT over 3000)
 - 70 (Highways w/Future ADT under 3000)
- Overall Standard Deviation ----- 0.45 *II-10*

Effective Roadbed Soil Resilient Modulus Calculation:

Season: _____ *Roadbed Soil Resilient Modulus (M_R):

- Frozen (Dec – Feb) 20,000 psi
 - Wet (Mar-May) Soils Data. See Chapter 5 for M_R values based on NGI
 - Optimum (Jun-Aug) “
 - Dry (Sept-Nov) “
- *May use 30,000 psi year round for lime, fly ash, or cement stabilized soils.
- Number of Construction Stage----- 1

Thickness Design (Specified)

Material Description	Struct Coeff.	Drain Coeff.	Thickness	One Direction Width
Asphalt	0.54 (<i>NCAT 09-03</i>)	1(<i>II-25</i>)	1 st Guess	Proposed Design

2.4c DARWIN Unbonded Concrete Overlay of Composite or Rigid with an Interlayer

Design Inputs

Date: Reviewed 2018

Source: Pavement Design Section

Description:

- Project Number
- Project Title
- Control Number
- Designer
- Date

The following inputs are values typically used by NDOT based on NDOT testing and design practices. Values may be adjusted as needed based on specific project details and in accordance with the 1993 *AASHTO Guide for Design of Pavement Structures*.

18-kip ESALs Over Initial Performance Period Calculation (Simple Tab):

- Performance Period (years) ----- 25
- Two-way Daily Traffic (ADT) ----- Current ADT
- Number of Lanes in Design Direction ----- Proposed Design
- % of All Trucks in Design Lane ----- 100 % (2-lanes) II-9
80 % (Expressway and Interstate)
60 % (6-lane, Range)
- % Trucks in Design Direction ----- 50 % II-9
- % Heavy Trucks (of ADT) ----- Current % of ADT
- Average Initial Truck Factor (ESALs/Truck) ----- See Average Initial Truck Factors table
- Annual Truck Factor Growth Rate (%) ----- 0 %
- Annual Truck Volume Growth Rate (%) ----- $((\text{Future TADT}/\text{Present TADT})^{(1/\text{yrs})} - 1) \times 100$
- Growth Rate ----- Compound
- Initial Serviceability ----- 4.4 II-10
- Terminal Serviceability ----- 3.0 (Interstate System)
2.5 (All other Highway Systems)
- 28-Day Mean PCC Modulus of Rupture ----- 668 psi
- 28-Day Mean Elastic Modulus of Slab ----- 3,860,000 psi
Mean Effective k-value: 96 psi/in (This is the worst case for our soils)
- Reliability Level (%) ----- 85 (Interstate System) II-9
80 (Expressway System)
75 (Highways w/Future ADT over 3000)
70 (Highways w/Future ADT under 3000)
- Overall Standard Deviation ----- 0.35 II-10
- Load Transfer Coefficient, J ----- 4.1 (Non-doweled conc. w/asph. or no shlds.) II-26
- Overall Drainage Coefficient, Cd ----- 1 II-26
- Examples on pages N90 through N92 of AASHTO 93 are all based on FWD data. We do not collect FWD data on rigid pavements.
- The 1993 Remaining Life method is cited as having major deficiencies. It is not applicable to composites or pavements with durability distress such as ASR.
- Effective Thickness Condition Survey- The maximum number of Deteriorated Transverse Joints and Cracks is 200 per mile, this is equivalent to an Adjustment Factor of 0.90. If all joints are repaired then the adjustment factor is 1.0. III-150

2.4d DARWIN Unbonded Concrete Overlay of Asphalt Design Inputs

Date: Reviewed 2018

Source: Pavement Design Section

Description:

- Project Number
- Project Title
- Control Number
- Designer
- Date

The following inputs are values typically used by NDOT based on NDOT testing and design practices. Values may be adjusted as needed based on specific project details and in accordance with the 1993 *AASHTO Guide for Design of Pavement Structures*.

18-kip ESALs Over Initial Performance Period Calculation (Simple Tab):

- Performance Period (years) ----- 25
- Two-way Daily Traffic (ADT) ----- Current ADT
- Number of Lanes in Design Direction ----- Proposed Design
- % of All Trucks in Design Lane ----- 100 % (2-lanes) II-9
80 % (Expressway and Interstate)
60 % (6-lane, Range)
- % Trucks in Design Direction ----- 50 % II-9
- % Heavy Trucks (of ADT) ----- Current % of ADT
- Average Initial Truck Factor (ESALs/Truck) ----- See Average Initial Truck Factors table
- Annual Truck Factor Growth Rate (%) ----- 0 %
- Annual Truck Volume Growth Rate (%) ----- $((\text{Future TADT}/\text{Present TADT})^{(1/\text{yrs})} - 1) \times 100$
- Growth Rate ----- Compound
- Initial Serviceability ----- 4.4 II-10
- Terminal Serviceability ----- 3.0 (Interstate System)
2.5 (All other Highway Systems)
- 28-Day Mean PCC Modulus of Rupture ----- 668 psi
- 28-Day Mean Elastic Modulus of Slab ----- 3,860,000 psi

Mean Effective k-value: When FWD data is available (Falling Weight Deflectometer)

Example: Use Concrete Overlay Module

- Import FWD data
- FWD results are dynamic so if nomographs are used, divide the composite k by 2 to get the static k. Darwin does this in the program.

Mean Effective k-value: When FWD data is NOT available

- Use Rigid Design Module to get this variable or calculate by nomographs pages II-39, II-41 and II-42. If nomographs are used remember to divide by 2 to get static because M_r and E_p are dynamic values.
- Seasonal variation is the only adjustment to the static k value to get the effective k value.

Example:

Roadbed	Base Elastic
Soil M_r (psi)	Modulus
4 seasons	Ep, Asphalt
20,000	300,000
2,100	300,000
4,600	300,000
5,000	300,000

- Mean Effective k=430 psi/in

- Base Type ----- Asphalt
- Subbase Thickness ----- Thickness between PCC Overlay and SG (generally the thickness of asphalt remaining after milling). Pg I-21 Definition

2.5 Average Initial Truck Factors

Date: will be updated 2018/19

Source: Pavement Design

Rigid Pavement

National Functional Classification			Factors*
	01	Interstate/Freeway	1.8013
Rural	02	Principal Arterial	1.3392
	06	Minor Arterial	1.2810
	07	Major Collector	0.8295
	11	Interstate	0.8715
Urban	12 & 14	Principal Arterial	0.9282
	16 & 17	Minor Arterial & Collector	0.6657

Flexible Pavement

National Functional Classification			Factors*
	01	Interstate/Freeway	1.1390
Rural	02	Principal Arterial	0.8823
	06	Minor Arterial	0.8680
	07	Major Collector	0.5611
	11	Interstate	0.5816
Urban	12 & 14	Principal Arterial	0.6859
	16 & 17	Minor Arterial & Collector	0.4817

*Truck Factors are recommended values based on National Functional Classification & adjusted for NE traffic.

2.5a NE National Functional Classification Map

<https://dot.nebraska.gov/media/2735/nat-func.pdf>

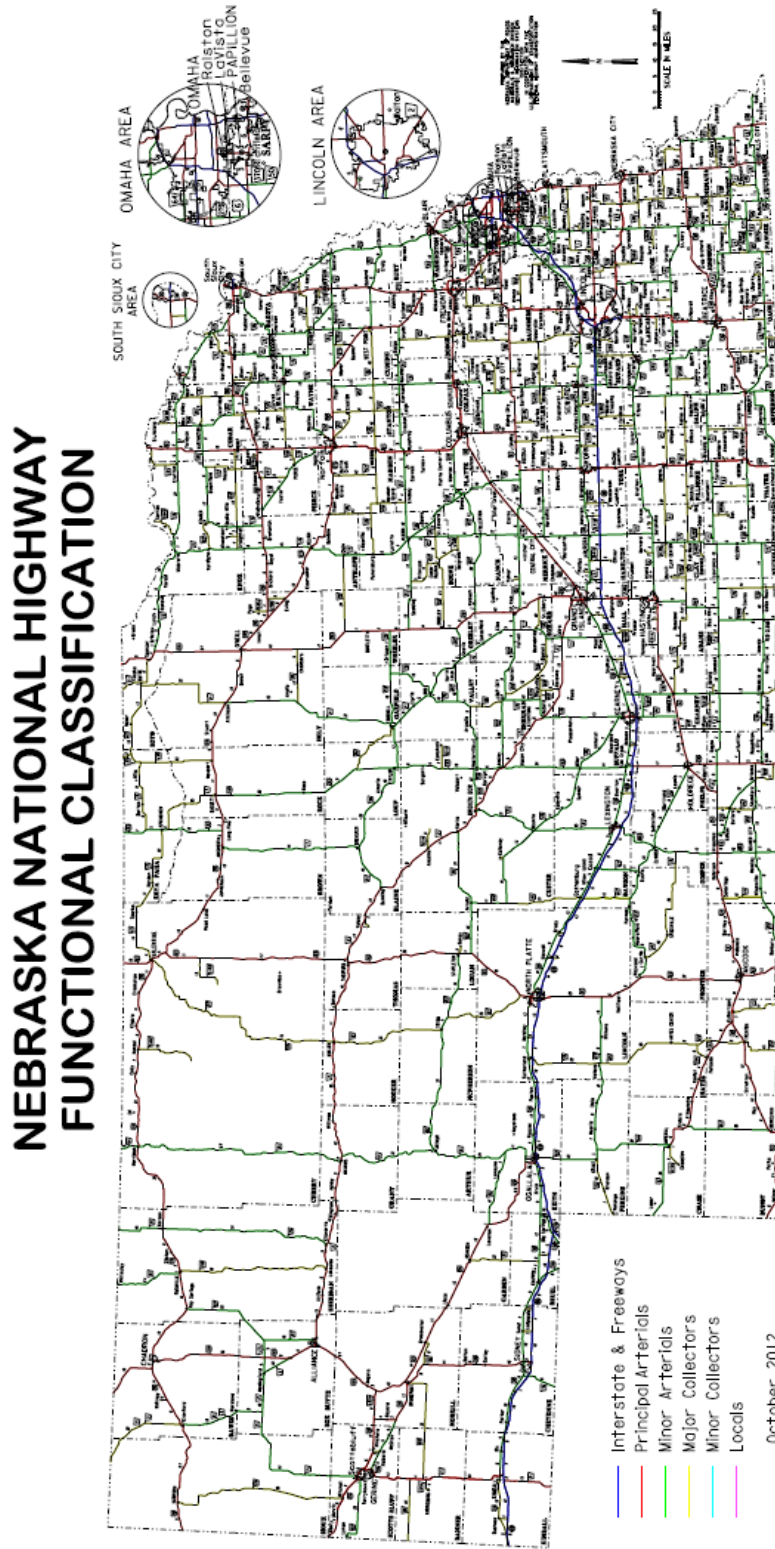

2.6 Design Standards Documentation

Date: 11-2018

Source: .Roadway Design Manual

Chapter Seventeen: Resurfacing, Restoration and Rehabilitation (3R) Projects Page 17-1/2

- Application of 3R design standards to a pavement resurfacing project is, for the most part, determined by the pavement recommendation. Pavement recommendations that require placement of more than 2 inches of surfacing or its equivalent will be designed to 3R standards.
- (Note: the **Materials and Research Division (M&R)** has determined that a roadway gains approximately 1/4 inch of new structure for every inch of a reclamation or recycle strategy, e.g. a pavement determination of 2 inches of reclamation followed by a 1.5 inch overlay is equivalent to a 2 inch thickness; therefore, a pavement rehabilitation strategy requiring the reclamation of 2 inches and resurfacing with 1.5 inches would be equivalent to a 2 inch resurfacing).

* 2" of equivalent structure can be defined as the thickness of a strategy other than HMA alone that will support the same traffic loading.

- 0.25" of recycle is equivalent to one inch of newly placed HMA.
- For example: 2" HIR would have an equivalent structure of 0.5". So a 2" HIR with a 1.5" HMA overlay would be developed to maintenance standards ($\leq 2"$) instead of 3R standards ($> 2"$).

2" HIR + 1.5" HMA		2" HMA	
Layer coefficient	SN	Layer coefficient	SN
$0.54 \times 1.5" =$	0.81	$0.54 \times 2" =$	<u>1.08</u>
$0.54/4 \times 2" =$	0.27		
	<u>1.08</u>		

- Pavement recommendations that require removal of the entire pavement structure and the construction of a new base or the modification of the existing base will be designed to reconstruction standards.
- Pavement recommendations that require pavement replacement and restoration of the base can be designed to 3R standards. Restoration of the base is defined as restoring the original condition of the base (subgrade preparation). A portion of the existing base may be removed to allow the required pavement thickness under 3R standards. Modification of the base is defined as improving (addition of a drainage layer) or strengthening the existing base through chemical (fly ash, lime, etc.) or mechanical (geofabric, geogrid, etc.) means and will require designing to reconstruction standards.

*Red comments added by Pavement Design Section

2.6a Proposed update to RDM

Pending inclusion in RDM Chap. 17, 11/27/2018

RESURFACING, RESTORATION AND REHABILITATION PROJECTS

Resurfacing, Restoration and Rehabilitation (3R) projects are generally undertaken to preserve and extend the life of highway assets. 3R projects improve the reliability of the transportation system, maintain the mobility of the highway user, and mitigate highway safety issues identified through an analysis of the crash history. A 3R project

usually involves pavement resurfacing or rehabilitation, sometimes accompanied by cross-section or roadside improvements. These projects may include, but are not limited to:

- Designing short segments to new and reconstructed standards (see below)
- Segments designated as maintenance activities
- Restoring the base to the original condition
- Removing a portion of the existing base to accommodate the required pavement thickness
- Recycling strategies which incorporate the existing road surfacing or structure into the base

3R Versus Other Work Types

Application of 3R design standards to highway resurfacing projects is typically based on pavement needs which are addressed by the pavement recommendation. A resurfacing project with a pavement recommendation that requires placement of more than 2 inches of surfacing or its equivalent¹ thickness will initially start through the design process under the assumption that 3R standards will be applied. In some cases discussed below, a typical 3R strategy may be constructed under Maintenance standards and a typical New and Reconstruction strategy constructed under 3R standards.

- **Maintenance Project Definition:** A maintenance strategy typically consists of ≤ 2 inches of surfacing with an expected service life of up to 12 years **(6-8 years typical)*. In rare cases, the typical maintenance strategy would be expected to fail well short of its intended service life due to a variety of factors. These factors include, but are not limited to the existing pavement condition, overall pavement thickness, truck loading, environmental conditions, etc. At the Roadway Designer's request, the Pavement Design Engineer may evaluate the expected life of a proposed maintenance strategy on a specific project. If the Pavement Design Engineer determines the proposed maintenance strategy will not meet its anticipated design life, the surfacing thickness may exceed 2 inches to achieve the expected design life with the project still constructed to maintenance standards.
- **3R Project Definition:** A 3R strategy typically consists of > 2 inches of surfacing with an expected service life of up to 20 years **(12-15 years typical)*.
- **New and Reconstruction Definition:** A New and Reconstruction strategy typically involves the construction or reconstruction of an entire pavement, base, and subgrade system with a service life exceeding 20 years. A pavement recommendation that requires replacement of the entire pavement structure and construction of a new base or modification² of the existing base will generally be designed to New & Reconstructed standards. However, practical design considerations may allow 3R standards in some situations, such as when reconstructing the pavement structure without modification² of the existing base or for reconstructing short segments (see below "Short Segments Within 3R Project Termini"), with or without modification of the existing base. In those cases, widening the highway cross section may be deferred to the future New & Reconstructed project.

**Red comments added by Pavement Design Section*

¹ The Materials and Research Division (M&R) has determined that 2" of recycle is structurally equivalent to 1/2" of HMA, e.g. a pavement determination of 2 inches of recycle followed by a 1.5-inch overlay is equivalent to a 2-inch resurfacing.

² Modification of the base is defined as improving (addition of a foundation course) or strengthening the existing base through chemical (fly ash, lime, etc.) or mechanical (geofabric, geogrid, etc.) means. It does not include Subgrade Preparation of an existing base which is considered Restoration of the base to original conditions.

Short Segments within 3R Project Termini

This section addresses when to widen, or not widen the cross section of short segments of the highway, within a 3R project, to New & Reconstructed standards. Examples are a spot location where a bridge, culvert or pipe is replaced, or where a minor length of base is replaced or modified.

Short segments built to New & Reconstructed standards are acceptable within 3R project termini, as mentioned on page 17-1. However, widening a short segment may not make the highway much, if any, safer. It can cause more environmental impacts and right-of-way acquisitions, increase costs and may delay the project, which also has a cost. It could also result in a segment that appears inconsistent to drivers and their expectations for a consistent, continuous driving experience.

Widening, or not widening, short segments or spot locations within 3R project termini shall be determined on a case-by-case basis by analysis. The analysis should compare the benefits and costs of alternatives, such as perpetuating the existing section or widening short segment(s) to New & Reconstructed standards, or something in between. If the analysis shows that the cost to widen the segment does not produce an adequate safety benefit, then widening the highway cross section may be deferred to a future New & Reconstructed project. The decision(s) is to be documented to the project file, with approval by the Section Head.

2.6b Beveled Edge & Rumble Strips

1. **Beveled Edge** – See Roadway Design Manual, Chapter 17
 - MicroStation cells for beveled edge are available on ProjectWise
 - A beveled edge is used when
 - Posted speed \geq 50 mph
 - Surface shoulders $<$ 6' in width
 - On depressed median side of expressways and interstates
 - Traffic division recommendation
 - A beveled edge is not used on maintenance projects

2. **Rumble Strips/Stripes** – See Roadway Design Manual
 - Chapter 8 – Surfacing;
7. - Rumble Strips and Rumble Stripes
 - Chapter 17 – Resurfacing, Restoration, & Rehabilitation (3R) Projects

2.7 Local Projects Pavement Design Guidance

Date: review 2018

Source: Varilek/Soula

NDOT is required by the Code of Federal Regulations (CFR) Title 23 to review all pavement designs for federally funded projects administered by the state. NDOT requires different levels of documentation for different types of pavement projects. Below are the required documentation requirements for:

Maintenance projects (2" or less of HMA), pavement repairs, minor intersection modifications (matching or exceeding existing pavement depths), preventative maintenance projects (micro-surfacing, armor coats, etc.)

- See 2.5 – First page of Local Projects Pavement Determination Data Sheet

Resurfacing, Restoration, and Rehabilitation (3R) Structurally enhance and extend the service life of an existing pavement and improve load carrying capacity (typical fill depth is greater than 2" and up to and including 6" of Asphaltic Concrete or Portland Cement Concrete.) Types of Improvements Include – Resurfacing, addition of auxiliary lanes, lane and shoulder widening, vertical and horizontal curves, and base repairs, etc.

New and Reconstruction (Resurfacing with >6" of HMA or PCC, new build HMA or PCC)

- Pg 1 & 2 or 1 & 3 of Local Projects Pavement Determination Data Sheet as applicable
- Appropriate tables, figures and nomographs

All design assumptions and calculations - See Nebraska Administrative Code Title 428, Chapter 2, pg. 39 for more information. <https://dot.nebraska.gov/media/5593/nac-428-rules-regs-nbcs.pdf>

Reference:

- AASHTO Guide For Design of Pavement Structures 1993 (Referenced as **AASHTO** below, may be purchased on-line.) NDOT uses and recommends the AASHTO design method. Other nationally accepted design methods may be acceptable.

AASHTO 93 Pavement Design Common Errors:

- Utilizing a 24.3 Growth Factor from Pavement Design Workshop example for all design scenarios
 - GF = 24.3 is only applicable for a 20 year performance period with 2% Growth Rate
- Assuming traffic projection time period (yrs.) must be the same as performance period (n).
 - The performance period (n) is independent of the traffic projection (yrs.) and can represent any design life the designer chooses. Typical values include 20 years for full depth HMA and 35 yrs. for full depth PCC.
- Not using direction or lane factors in ESAL calculation typically resulting in 2X the appropriate ESALs.

Summary of AASHTO 93 Pavement Design Process for *Local Projects*

Input values are based on specific project details and in accordance with the *1993 AASHTO Guide for Design of Pavement Structures*.

Any nationally recognized design method, such as PavEXpress, StreetPave, or WinPASS are acceptable.

Calculating Equivalent Single Axle Load (ESAL):

1. Calculate Traffic Growth Rate: $GR = ((\text{Future ADT}/\text{Present ADT})^{(1/\text{yrs})} - 1) * 100 =$
2. Calculate Traffic Growth Factor: $GF = ((1+g)^n - 1)/g =$ $g = GR/100$
 - a. GF equation may be used in lieu of interpolation of *Table D.20 pg D-24 AASHTO*
 - b. n = Analysis Period also known as Performance Period or Design Life. This variable (n) is independent of the time period associated with the traffic projection (yrs).
3. Calculate ESALs: $ESALs = \text{Present ADT} \times 365 \text{ days/yr} \times HT \times GF \times TF \times D_D \times D_L$
 - a. HT = Heavy Trucks (%/100)
 - b. GF = Traffic Growth Factor calculated above
 - c. TF = Truck Factor
 - i. Use single Truck Factor and ESAL calculation based on National Functional Classification, **OR**
 - ii. Multiple Truck Factors if detailed traffic distribution is known or assumed *pg D-25 AASHTO*
 - d. D_D = Directional Distribution Factor (%/100) *pg II-9 AASHTO*
 - e. D_L = Lane Distribution Factor (%/100) *pg II-9 AASHTO*

Flexible Pavement Design (New Build)

1. Calculate ESALs as shown above
2. Calculate Effective Roadbed Soil Resilient Modulus (M_R) *pg II-14 Fig. 2.3 AASHTO*
 - a. Opt, wet, dry M_R values for NE soils available
 - b. Frozen and chemically stabilized M_R values available
 - c. Note: nomograph can be replaced by $u_f = 1.18 \times 10^8 \times M_R^{-2.32}$ *pg II-14 AASHTO*
3. Estimate Design Structural Number (SN) *pg II-32 Fig. 3.1 AASHTO*
4. Identify desired materials and required depths to meet SN through iterative process. There are numerous potential solutions to any given SN *pg II-35 AASHTO* $SN = a_1 D_1 + a_2 D_2 m_2 + a_3 D_3 m_3 + \dots$
 - a. a_1, a_2, a_3 = layer coefficients of surface, base and subbase
 - i. typical coefficients available
 - b. D_1, D_2, D_3 = depths of surface, base and subbase
 - c. m_2, m_3 = drainage coefficients of base and subbase
 - i. coefficients available *pg II-25 Table 2.4 AASHTO*

*Flexible Pavement Design Example available in *Appendix H AASHTO*

Rehabilitation of Flexible Pavement – Condition Survey Method:

(Used for HMA overlay, mill and overlay, recycle and overlay, etc.)

1. Calculate required Structural Number; Steps 1-3, Flexible Pavement Design (New Build)
2. Identify desired material(s) and required depth(s) to meet SN through iterative process *pg II-35 AASHTO*
 $SN = a_1 D_1 + a_2 D_2 m_2 + a_3 D_3 m_3 + \dots$

- a. Process similar to Step 4, Flexible Pavement Design (New Build). Primary difference is rehabilitation typically only involves HMA surface, leaving existing HMA, base, subbase, etc. below.
 - i. Age and condition of existing underlying materials must be taken into consideration when assigning layer coefficients.
 - ii. Typical coefficients available
- b. A shorter performance period may be appropriate depending on scope of rehabilitation

Rigid Pavement Design (New Build):

1. Calculate ESALs as shown above
2. Calculate Effective Modulus of Subgrade Reaction (k) *pg II-38 Table 3.2 AASHTO*
 - a. Estimate Roadbed Resilient Modulus (M_R) for each season
 - i. Opt, Wet, Dry M_R values for NE soils available
 - ii. Frozen and chemically stabilized M_R values available
 - b. Estimate Subbase Elastic Modulus (E_{SB}) **ONLY IF** design includes foundation course for each season
 - c. Calculate Composite Modulus of Subgrade Reaction (k) *pg II-39 Figure 3.3 AASHTO* for designs with foundation course **OR** $k = M_R/19.4$ for slab on grade *pg II-44 AASHTO* for each season
 - d. Modify k-value for effect of rigid foundation if bedrock within 10' *pg II-40 Fig 3.4 AASHTO* for each season if necessary. This step typically not applicable in NE.
 - e. Calculate Relative Damage to pavement *pg II-41 Fig 3.5 AASHTO* for each season based on Composite k value calculated in step c (unless step d was used).
 - f. Calculate Average Relative Damage by completing *pg II-38, Table 3.2 AASHTO*
 - g. Back calculate composite k value using Average Relative Damage *pg II-41 Fig 3.5 AASHTO*
 - h. Correct k value for loss of support *pg II-42 Fig 3.6 AASHTO*
3. Estimate required pavement thickness *pg II-45 Fig 3.7 AASHTO*
 - a. This is the minimum required thickness based on project inputs. Local minimum design policies, engineering judgment, constructability issues, etc. may dictate additional depth.

*Rigid Pavement Design Example available in *Appendix I AASHTO*

Rehabilitation of PCC – PCC Condition Survey Method:

(Used for HMA overlay of PCC)

1. Calculate required slab depth for future traffic (D_f); Steps 1-3, Rigid Pavement Design (New Build)
2. Calculate the effective depth of existing PCC based on condition $D_{eff} = F_{jc} \times F_{fat} \times F_{dur} \times D_{ex}$ *pg III-121 AASHTO*
 - a. D_{eff} = Effective slab depth (in)
 - b. F_{jc} = Joints and Cracks adjustment factor
 - c. F_{fat} = Fatigue Damage adjustment factor
 - d. F_{dur} = Durability adjustment factor
 - e. D_{ex} = Existing slab depth (in)
 - i. Recommended factors *pg III-123 AASHTO*
3. Calculate A factor $A = 2.2233 + 0.0099(D_f - D_{eff})^2 - 0.1534(D_f - D_{eff})$ *pg III-115 AASHTO*
 - a. D_f = Slab depth for future traffic (in)
4. Calculate depth of overlay required (D_{ovl}). $D_{ovl} = A(D_f - D_{eff})$ *pg III-115 AASHTO*

2.7a Local Projects Pavement Determination Data Sheet

LPPD Data Sheet, Page 1 of 3

Pavement Determination Data Sheet		
Project Name	
Project No.	
Control No.	
Letting Date	
Prepared by	
Date	
Scoping Information		
Pavement Determination		
Mainline-		
Shoulder-		
Patching-		
Pavement History		
Top Layer	
Intermediate	
Intermediate	
Base layer	
Subgrade	
Pavement Management System or Field Visit Information		
HMA		PCC
Rutting (mm)	Cracking(%)
Cracking (%)	Faulting
Rating	Rating
Cores		Soils
Location	Depth	Comments
1
2
3
4
5
6
7
8
Design Method Used:		AASHTO
Structure Number (HMA) or Thickness (PCC) Required for ESAL's	
Structure Number or Thickness Designed (must be ≥ required)	
		Traffic
		Current ADT
		yr Forecast ADT
		% Heavy Trucks
		Predicted ESAL's

Flexible Design Inputs	
<p style="text-align: center;">Structure Number based on ESAL's</p> Performance Period (Yrs) _____ Number of Lanes in Design Direction _____ % of Trucks in Design Lane _____ % of Trucks in Design Direction _____ Average Initial Truck Factor (ESALS/Truck) _____ Traffic Growth Rate (GR) _____ Traffic Growth Factor (GF) _____ Initial Serviceability _____ Terminal Serviceability _____ Reliability Level _____ Overall Standard Deviation _____ Structure Number Required 	<p><i>Use this method for New Build design or for establishing required structure number for comparison to Rehabilitation design.</i></p> <p><i>Use these inputs & the Flexible Pavement Nomograph (Figure 3.1, pg. II-</i></p>
HMA Condition Survey Method (Rehabilitation)	
<p style="text-align: center;">Surface Course</p> Type Depth (D ₁ , inches) _____ Layer Coefficient (a ₁) _____ Structure No. for Layer (SN ₁) _____	<p><i>Use this method for Rehabilitation of existing asphalt roadways or for Bituminous Recycling Strategies</i></p> <p>$SN_1 = D_1 \times a_1$</p>
<p style="text-align: center;">Base Layer</p> Type Depth (D ₂ , inches) _____ Layer Coefficient (a ₂) _____ Drainage Coefficient (m ₂) _____ Structure No. for Layer (SN ₂) _____	<p>$SN_2 = D_2 \times a_2 \times m_2$</p>
<p style="text-align: center;">Sub-Base Layer</p> Type Depth (D ₃ , inches) _____ Layer Coefficient (a ₃) _____ Drainage Coefficient (m ₃) _____ Structure No. for Layer (SN ₃) _____	<p>$SN_3 = D_3 \times a_3 \times m_3$</p>
Total Structure Provided (SN ₁ + SN ₂ + SN ₃ + ...) 	
<p style="text-align: center;"><i>Add or Subtract Layers as</i></p>	
<p>Comments:</p> 	

Rigid Design Inputs						
<div style="display: flex; justify-content: space-between;"> <div style="width: 45%;"> <p>Thickness based on ESAL's</p> <p>Performance Period (Yrs) _____</p> <p>Number of Lanes in Design Direction _____</p> <p>% of Trucks in Design Lane _____</p> <p>% of Trucks in Design Direction _____</p> <p>Average Initial Truck Factor (ESALS/Truck) _____</p> <p>Traffic Growth Rate (GR) _____</p> <p>Traffic Growth Factor (GF) _____</p> <p>Initial Serviceability _____</p> <p>Terminal Serviceability _____</p> <p>28-Day Mean PCC Modulus of Rupture _____</p> <p>28-Day Mean PCC Elastic Modulus of Slab _____</p> </div> <div style="width: 45%; border: 1px solid black; padding: 5px;"> <p><i>Use this method for New Build design or for establishing Required thickness for comparison to Rehabilitation design.</i></p> </div> </div>						
<p>Base Type _____</p> <p>Base Thickness _____</p> <p>Depth to Bedrock _____</p> <p>Projected Slab Thickness _____</p> <p>Loss of Support _____</p> <p>Reliability Level _____</p> <p>Overall Standard Deviation _____</p> <p>Load Transfer Coefficient _____</p> <p>Drainage Coefficient _____</p>	<p>Thickness Required (D_r) <input style="width: 100%;" type="text"/></p>					
<div style="border: 1px solid black; padding: 5px; display: inline-block;"> <p><i>Use these inputs & the Rigid Pavement Nomograph (Figure 3.7, pg. 11-45)</i></p> </div>						
PCC Condition Survey Method (Rehabilitation)						
<div style="display: flex; justify-content: space-between;"> <div style="width: 45%; border: 1px solid black; padding: 5px;"> $D_{ovl} = A (D_r - D_{ex})$ </div> <div style="width: 45%; border: 1px solid black; padding: 5px;"> <p><i>Use for Rehabilitation(HMA overlay) for existing concrete roadways</i></p> </div> </div>						
<div style="border: 1px solid black; padding: 5px; margin: 5px auto; width: 80%;"> $A = 2.2233 + 0.0099 (D_r - D_{ex})^2 - 0.1534 (D_r - D_{ex})$ </div>						
<div style="border: 1px solid black; padding: 5px; margin: 5px auto; width: 80%;"> $D_{ex} = F_{jc} \times F_{fat} \times F_{dur} \times D_{ex}$ </div>						
<div style="border: 1px solid black; padding: 5px;"> <p><u>Definitions:</u></p> <p>D_{ovl} = HMA overlay thickness (inches)</p> <p>D_r = PCC required thickness (inches) based on ESAL's</p> <p>D_{ex} = Condition Survey or factor of existing PCC as thickness (inches)</p> <p>D_{ex} = Existing PCC Depth</p> <p>A = Conversion number for PCC to HMA</p> <p>F_{jc} = Joint & Crack adjustment factor (1.0 - 0.5)</p> <p>F_{fat} = Fatigue Damage adjustment factor (1.0 - 0.9)</p> <p>F_{dur} = Durability Factor (1.0 - 0.8)</p> </div>						
<table border="1" style="width: 100%; border-collapse: collapse;"> <tr><td style="padding: 2px;">F_{jc} = _____</td></tr> <tr><td style="padding: 2px;">F_{fat} = _____</td></tr> <tr><td style="padding: 2px;">F_{dur} = _____</td></tr> <tr><td style="padding: 2px;">D_{ex} = _____</td></tr> <tr><td style="padding: 2px;">D_{ex} = _____</td></tr> </table>	F_{jc} = _____	F_{fat} = _____	F_{dur} = _____	D_{ex} = _____	D_{ex} = _____	<div style="display: flex; justify-content: space-around; margin-top: 10px;"> <div style="border: 1px solid black; padding: 5px;">A = <input style="width: 50%;" type="text"/></div> <div style="border: 1px solid black; padding: 5px;">D_{ovl} = <input style="width: 50%;" type="text"/></div> </div>
F_{jc} = _____						
F_{fat} = _____						
F_{dur} = _____						
D_{ex} = _____						
D_{ex} = _____						
<p>Comments:</p>						

2.7b Local Projects Preliminary and Final Checklists

Date: 2018

Source: Local Projects



Design

Preliminary Pavement Design

Checklist # 06-12 page 1 of 3

Instructions for Use: Sections of this form are to be completed by the LPD PC before forwarding to NDOT M&R Pavement Design Section to check the Pavement Design related items on the 30% Plan Set. The NDOT LPD PC will submit a copy of the 30% PIH Plan set and the Pavement Determination to NDOT M&R to conduct this review.

Local Public Agency (LPA):	LPA Responsible Charge:	
State Project No.:	Project Name and Location:	
State Control No.:	Date of Review:	This Form was Completed By:

This section to be completed by the LPD PC:

Item #	Task Description or Questions	Completed			If No, Define Corrective Action	Details or Information Used to Verify Content	Additional Comments
		Yes	No	N/A			
1.	Have the 30% PIH plans been submitted and are they ready for review?	<input type="checkbox"/>	<input type="checkbox"/>	<input type="checkbox"/>			A pavement design analysis is not required for maintenance projects.
2.	Has the Pavement Determination Data Sheet (PDDS) been submitted?	<input type="checkbox"/>	<input type="checkbox"/>	<input type="checkbox"/>			Sheet 1 required for maintenance projects (<2" HMA). Sheets 1 & 2 or 1 & 3 required for resurfacing and new build projects. Appropriate nomographs required for new build.
3.	Will a Permit to Occupy State ROW be required and has that been noted on the submittal memo?	<input type="checkbox"/>	<input type="checkbox"/>	<input type="checkbox"/>			Only if applicable.
4.	Has the LPA notified the PC of any known relaxation of design standards?	<input type="checkbox"/>	<input type="checkbox"/>	<input type="checkbox"/>			

Remaining sections to be completed by Materials and Research.

Remaining Pavement Design

Item #	Task Description or Questions	Completed			If No, Define Corrective Action	Details or Information Used to Verify Content	Additional Comments
		Yes	No	N/A			
5.	Has a copy of the pavement design analysis been received?	<input type="checkbox"/>	<input type="checkbox"/>	<input type="checkbox"/>			A pavement design analysis is not required for maintenance projects.
6.	Was the pavement design developed using a nationally recognized method? (<i>AASHTO, Asphalt Institute Method, Portland Cement Association</i>)	<input type="checkbox"/>	<input type="checkbox"/>	<input type="checkbox"/>			
7.	Are all of the necessary inputs for the pavement design included? (<i>ADT, %HT, expected life, layer coefficients...</i>)	<input type="checkbox"/>	<input type="checkbox"/>	<input type="checkbox"/>		Design Analysis Input and Output	
8.	Does the pavement strategy seem reasonable for the project scope? (<i>Check for constructability issues, material availability, etc.</i>)	<input type="checkbox"/>	<input type="checkbox"/>	<input type="checkbox"/>		Existing Pavement Information, existing pavement determination, material testing information.	
9.	Have all the pavement mix types been pre-approved?	<input type="checkbox"/>	<input type="checkbox"/>	<input type="checkbox"/>		All asphalt or concrete must be a current NDOR mix.	

Plans

Item #	Task Description or Questions	Completed			If No, Define Corrective Action	Details or Information Used to Verify Content	Additional Comments
		Yes	No	N/A			
10.	Do the project plans have typical sections or details that address all of the necessary pavement work?	<input type="checkbox"/>	<input type="checkbox"/>	<input type="checkbox"/>			
11.	Have all the pavement related items been properly labeled in the typical section or detail? (<i>Depth of strategy, shouldering, preparation, inlays</i>).	<input type="checkbox"/>	<input type="checkbox"/>	<input type="checkbox"/>			
12.	Is the existing pavement depth shown or described on the plans? (Needed for all removal, rehabilitation, repair or recycling sections of the project)	<input type="checkbox"/>	<input type="checkbox"/>	<input type="checkbox"/>			

Chapter 3: Pavement Design Guidance

3.1 Hot Mix Asphalt Guidance

Date: 2018

Source: Pavement Design

Use	Mix Type
Mainline: 0 – 750 Heavy Trucks per day	SPR, SPR(fine)
Expressway and High Traffic Urban	SLX
Interstate	SPH
Shoulder	SPS

Performance Graded Binders

Mainline	SPH		PG 58V-34
Mainline	SPR, SPR(fine)		PG 58H-34 (if current ADT ≤ 150) PG 58V-34 (if current ADT >150)
Mainline	SRM		PG 58H-34
Mainline	SLX		PG 58V-34
Leveling Course,	Type LC		PG 58V-34
Shoulder	SPS		PG 58S-34
Temporary Interstate/Expressway	SPR		PG 58V-34 or 58E-34
Temporary Non Interstate/Expressway	SPR		PG 58H-34 if RAP ≥ 40%, 58V-34, 58E-34

A Performance Graded Binder means that tests are performed to measure the physical properties of the binder. The first number represents the 7 day maximum pavement design temperature in degrees Celsius (°C). The second number is the lowest single day design temperature in degrees Celsius (°C). For example, a binder graded as PG 70-28: Resists deformation up to 70°C (158°F) and Thermal Cracking to -28°C(-18°F)

The Multiple Stress Creep Recovery (MSCR) Grading System no longer requires bumping the high temperature number for high truck volume roadways for the purpose of resisting rutting. Instead, the average 7 day maximum pavement temperature is used in degrees Celsius (°C) and a letter designator is used to adjust for truck volume. The letter designators for truck volumes are as follows: S – standard, H – heavy, V – very heavy, and E – extremely heavy. For example, 58°C binder previously achieved additional rut resistance by bumping to a 64°C binder.

HMA Modifiers

- Acid – Polyphosphoric Acid (restricted use)
- Styrene Butadine Styrene (SBS) – Synthetic Polymer
- Styrene Butadine Rubber (SBR) – Synthetic Polymer
- Crumb Rubber – Ground rubber from tires

Thickness Guidance

Heavy Trucks per Day	Thickness**
0 – 200	8"
200 – 1600	10" (8" in pure sand regions)
1600+	12" (10" in pure sand regions)

**AASHTO 93 currently used to determine structural thickness

Gradation

$\frac{3}{16}$ " (0.19) gradation band for thicknesses < 1", Type LC only

$\frac{3}{8}$ " (0.375) gradation band for thicknesses ≥ 1 ", SPH or SPR(fine)

$\frac{1}{2}$ " (0.5) gradation band for thicknesses $\geq 1 \frac{1}{2}$ ", SPH or SPR

Aggregate Gradation for HMA

Date: Dec 06

Source: Virtual Superpave Laboratory

Virtual Superpave Laboratory

Types of Aggregate Gradation

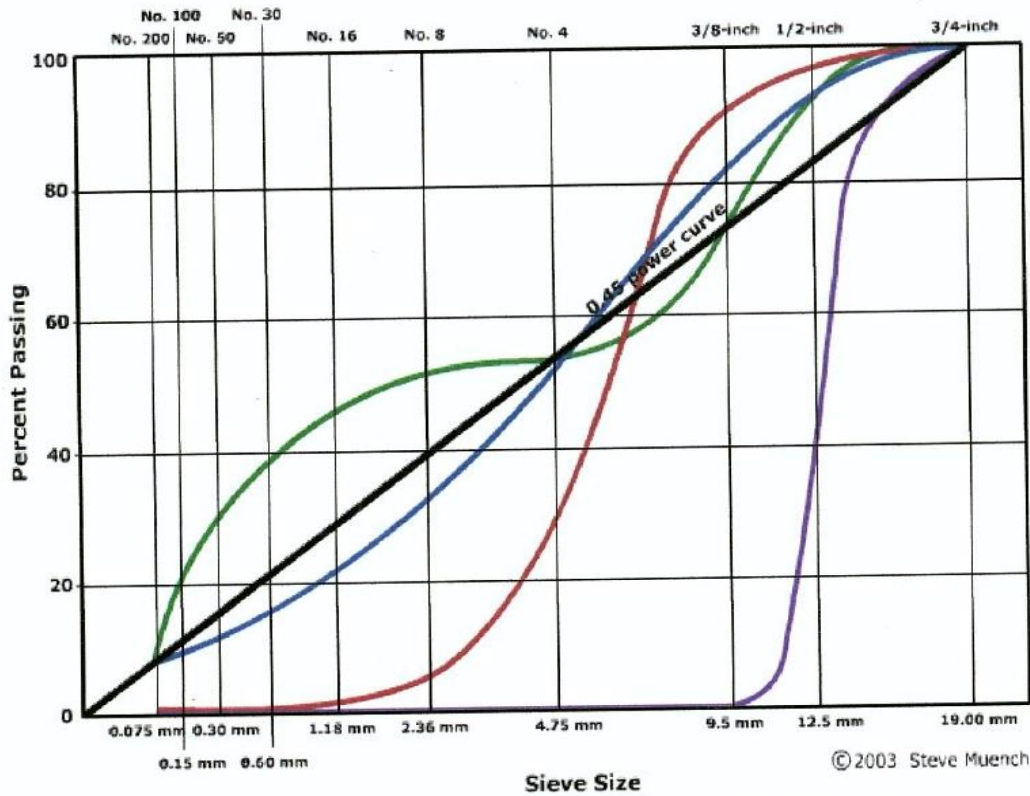

©2003 Steve Muench

REMOVE Dense Gradation

REMOVE Uniform Gradation

REMOVE Open Gradation

REMOVE Gap Gradation

3.2 Current Hot Mix Asphalt Designs

Date: 2018

Source: Pavement Design

The following list outlines our most recent updates and applications for our flexible pavement designs. We continue to modify and improve upon the asphalt mix types based on actual field performance, in an effort to address certain performance parameters. We are simplifying the number of our mixes in use and changing/condensing our current ones. Other than some of our ‘special application mixes’ that are still in test and evaluation stages, our standard mixes are now going to be limited to 6 types: **LC, SPS, SPR, SLX, SRM, and SPH.**

Type LC – LC stands for Leveling Course. This mix is primarily used as a scratch course or leveling course. It is used on bare concrete or on heavily patched roadway segments that are rough, and intended to improve smoothness on subsequent lifts. It is an extremely fine graded mix with a high binder content and low voids, this produces a mix that is very dense and utilizes high amounts of polymer in the binders.

Type SPS – Superpave Surfacing for Paved Shoulder mix. It uses PG 585-34 (2016) at a content to yield a target air void of 1.5%. It promotes the use of RAP at a content of 35 to 50% and thus reduces the amount of added binder and aggregates by as much as half. It contains no lime.

Type SPR – (≤ 750 trucks) SPR stands for Superpave Recycle mix. This mix combines high quality angular aggregates with typically 45 to 50% RAP. High quality and highly polymerized 58V-34 binders are used along with improved dust to asphalt ratios, giving this mix high mastic and film thickness’s and high strength modulus values that provide superior structural value, rut resistance and also improved in-place density. It also has better laydown and placement characteristics, that provide less permeability and more resistance to aging and longitudinal joint deterioration.

TYPE SPH – (< 750 trucks) SPH stands for Superpave Heavy-load mix. This mix is used in heavy truck applications such as Interstates, Expressways, and large volume urban corridors. This mix consists of high angularity aggregates and typically 15 to 25% RAP, gyratory compaction levels have been modified to be consistent with today’s performance requirements in order to improve binder contents and dust to asphalt ratios. This will provide better long term durability, reduced permeability and improved in-place density. This mix utilizes high polymer modification in binders with the use of 58V-34.

Type SLX – This mix was originally developed for thin lift maintenance projects, but its use has grown to include expressway overlay projects and high truck volume corridors. In recent comparative research, it has performed well compared to asphaltic concrete Type SPH with regard to its rut resistance. Type SLX has better joint density values when compared to SPH, making it a preferred mix for urban high volume applications. The mix has a minimum of 20%, $\frac{1}{4}$ ” aggregate chips that provide increased angularity. The binder used is typically 58V-34.

Type SRM – This mix was developed as an alternate to recycling strategies. The mix allows up to 65% RAP, has a minimum crushed rock content of 10%, making this a stiff base mix capable of bridging locations with asphalt stripping. This mix requires a surface course mix of either Types SLX or SPR. The stiffer RAP binder is offset with a 58H-34 binder.

3.3 Relinquishment Policy

Date: 2-12-18

Source: Operating Instruction 60-13

<https://interchange.nebraska.gov/media/1136/60-all.pdf>

Nebraska Department of Transportation
Operating Instruction 60-13
February 12, 2018

RELINQUISHMENT OF ROADS FROM THE HIGHWAY SYSTEM

- *** 1. **Purpose:** To provide policy for the relinquishment of roads, by preparation, distribution, and disposition of relinquishment agreements between the Nebraska Department of Transportation and an outside party. The office of primary responsibility for this DOT-OI is the Project Development Division. This DOT-OI supersedes DOT-OI 60-13 dated September 25, 2007.
2. **General:**
When a segment of highway is relocated, the functional classification of the old highway will be changed. The Department will offer to relinquish to the political or governmental subdivision(s) or public corporation(s), any portion of the old state highway that has been relocated. If an offer to relinquish a highway segment is not accepted by the local jurisdiction(s), the State may abandon it as provided by law (See Section 8 "Abandonment of Roadway"). The Department will relinquish the highway to the local agency after following the approved policy for relinquishment of highways.
Before relinquishment, the Department will evaluate the condition of the roadway to determine the need for any rehabilitation. It is the intent of the Department to only relinquish roads that will provide suitable service for the traveling public.
- *** Other than surface rehabilitation, improvements to the roadway will not be made. At the time of relinquishment, the Nebraska Department of Transportation (NDOT) will assess the adequacy of structures and determine if any reparation or corrective action is required. It is the intent of the State to relinquish only those structures which are structurally and functionally adequate for the purpose for which they will be used.
- *** In any relinquishment or closure proceeding where the NDOT owns fee simple title to the underlying land, ownership should be reserved by the NDOT. However, the land may be sold according to Nebraska Statute Sec. 39-1325. If sold, the contract must guarantee that utility companies have a perpetual right to utilize the former state right of way.
- *** Whenever a public hearing for a highway project is held, the Department of Transportation's presentation will include a statement explaining the proposed changes in the highway system and the proposed segments of the existing highway to be relinquished to local jurisdiction.
A highway may be automatically relinquished by the state when its functional classification changes. However, it is preferable to acquire a signed relinquishment agreement with the County or City prior to highway removal or location approval.
- *** The relinquishment or abandonment of a highway segment must be recommended by the NDOT and the Highway Commission and approved by the Governor. This action should take place at the location approval stage.

*** = Denotes changes

(Page 1 of 6)

3.4 PCC Pavement Design Guidance

Date: 2/14/18

Source: Jamshidi

February 14, 2018

PORTLAND CEMENT CONCRETE PAVEMENT DESIGN GUIDANCE

1. This guidance supersedes the “Portland Cement Concrete Pavement Design Policy” dated February 11, 2000.

2. The “AASHTO Guide for Design of Pavement Structures”, 1993, should be used as a guide for the pavement type selection and design process. The output from this software will be analyzed and on a project basis may be adjusted based on engineering judgment.

3. Rigid Pavement Design – All rigid pavement should be plain jointed Portland Cement Concrete including dowel bars at all transverse joints as follows:

a. Rural Areas – In rural areas epoxy coated dowel bars should be placed at 12 in. centers at all transverse joints.

b. Urban Areas – In urban areas dowel bars shall be used in all transverse joints with widths greater than or equal to 6 ft. At intersections, the joint layout will be evaluated to determine which joints should be tied or doweled.

4. Minimum Pavement Thickness – The minimum pavement thickness of Portland Cement Concrete pavement on the State Highway System should be as follows:

Interstate System.....	12 in.
Expressway System, Based on EASLs	9 in.
All other Highways, Based on EASLs	8 in.
Maintenance Turnarounds	8 in.

5. Final Pavement Thickness – The pavement thickness to be constructed, subject to the minimum pavement thickness defined above, will be the required pavement thickness using the AASHTO Guide for Design of Pavement Structures rounded up to the nearest 1 in.

6. Transverse Joint Spacing – Transverse joints should be at 16’-6” placed perpendicular to the centerline. If joint spacing needs adjusted to match existing pavement the transverse spacing shall be reduced.

7. Longitudinal Joint Spacing – Interstate joint spacing shall be shown in the pavement determination. Longitudinal joint spacing should not exceed 16’-0”.

8. Tied Concrete Shoulders – Rigid pavement projects will be reviewed on a case by case basis to determine if full width Portland Cement Concrete shoulders are justified. The minimum concrete shoulder design for Interstate, Expressway and DR-2 non-expressway roads is a monolithically poured inside shoulder and passing lane. The outside shoulder thickness design shall be determined during the pavement design process.

Recommended:

Mick Syslo
Materials and Research Engineer

Approved:

Moe Jamshidi
Deputy Director, NDOT

3.5 Road Damage vs. Axle Loading Comparison

Date: ?
Source: AASHTO

Road Damage VS Axle Load

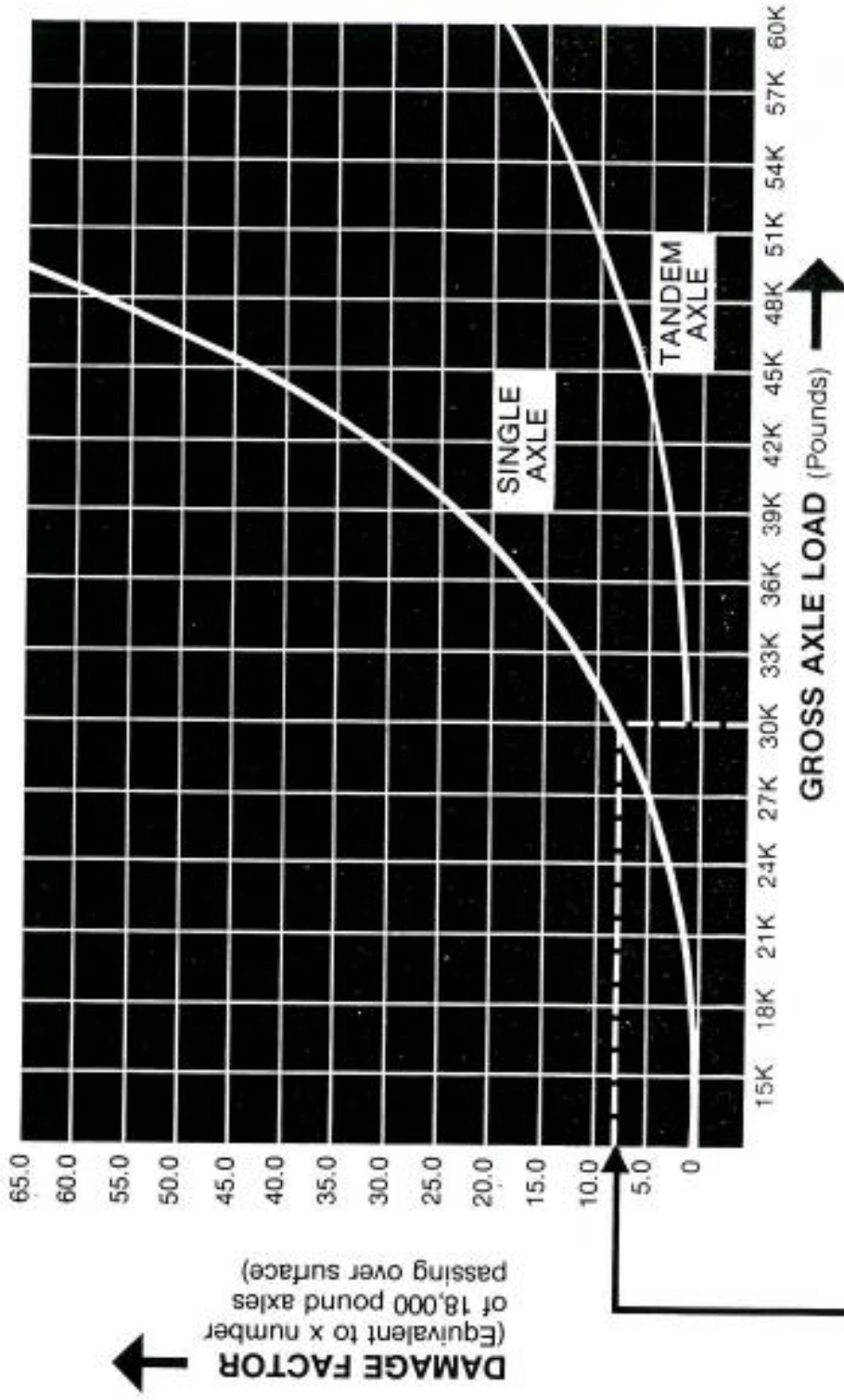

DAMAGE FACTOR
(Equivalent to x number of 18,000 pound axles passing over surface)

NOTES: 1. Residual Performance Value P=2.5
2. Slab thickness for rigid pavement D=9"
3. Reference—these curves derived from A.A.S.H.T.O. data

***EXAMPLE**
1 each 30,000 lb. single axle is equivalent to 8 each 18,000 lb. axles passing over surface

5-8-22

Road Damage

vs

Axle Load

ROAD DESIGN AND DAMAGE CRITERIA ARE BASED ON AXLE LOAD

Data from American Association State Highway Transportation Officials Studies (A.A.S.H.T.O.)
U.S. Government Data - Washington, D.C., U.S.A.

SINGLE AXLE

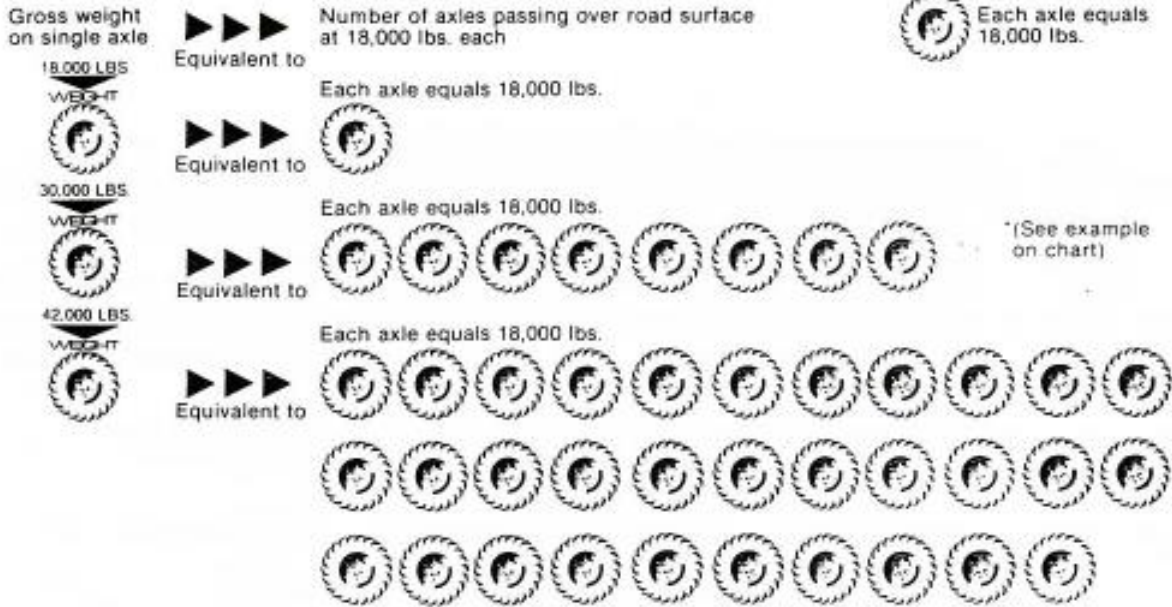

TANDEM AXLE

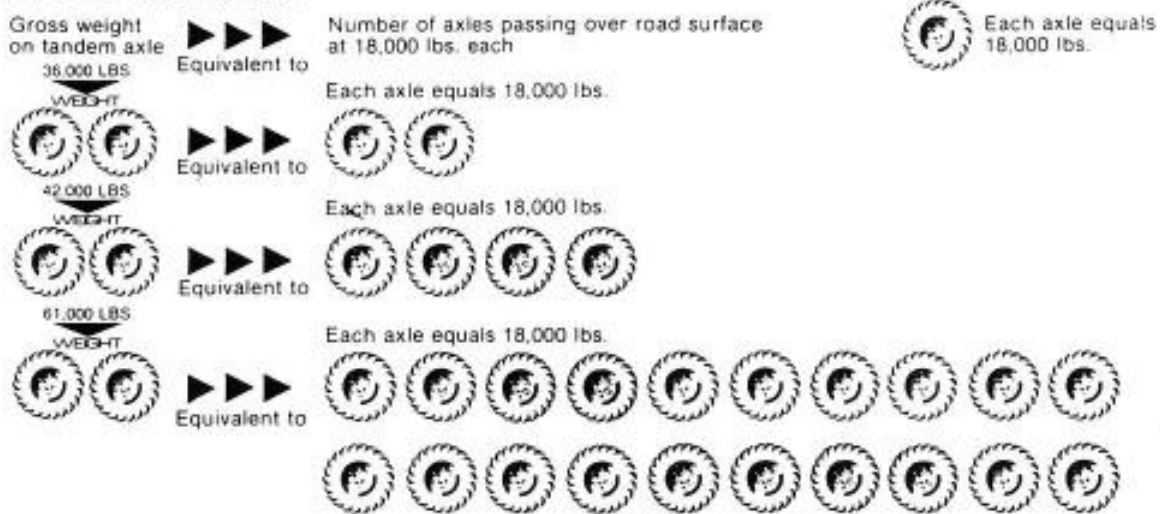

5-8-23

3.6 Vehicle Classifications

Date: 2001

Source: http://pavementinteractive.org/index.php?title=Trucks_and_Buses

















The FHWA classifies vehicles in terms of their configuration rather than weight. This type of classification system is more conducive to traffic applications but can be adapted for pavement loading applications. It can also be easily confused with the vehicle manufacturer’s truck classification system. The FHWA *Traffic Monitoring Guide* (TMG) recommends classifying vehicles into 13 different categories. Figures 4 through 9 show some FHWA vehicle class examples.

Table 2. FHWA Vehicle Classification (from FHWA, 2001)¹

Class	Type	Description	Typical ESALs per Vehicle ²
1	Motorcycles	All two- or three-wheeled motorized vehicles. Typical vehicles in this category have saddle type seats and are steered by handle bars rather than wheels. This category includes motorcycles, motor scooters, mopeds, motor-powered bicycles, and three-wheel motorcycles. This vehicle type may be reported at the option of the State.	negligible
2	Passenger Cars	All sedans, coupes, and station wagons manufactured primarily for the purpose of carrying passengers and including those passenger cars pulling recreational or other light trailers.	negligible
3	Other Two-Axle, Four-Tire Single Unit Vehicles	All two-axle, four tire, vehicles, other than passenger cars. Included in this classification are pickups, panels, vans, and other vehicles such as campers, motor homes, ambulances, hearses, and carryalls. Other two-axle, four-tire single unit vehicles pulling recreational or other light trailers are included in this classification.	negligible
4	Buses	All vehicles manufactured as traditional passenger-carrying buses with two axles and six tires or three or more axles. This category includes only traditional buses (including school buses) functioning as passenger-carrying vehicles. All two-axle, four-tire single unit vehicles. Modified buses should be considered to be a truck and be appropriately classified.	0.57
5	Two-Axle, Six-Tire, Single Unit Trucks	All vehicles on a single frame including trucks, camping and recreational vehicles, motor homes, etc., having two axles and dual rear wheels.	0.26

6	Three-Axle Single Unit Trucks	All vehicles on a single frame including trucks, camping and recreational vehicles, motor homes, etc., having three axles.	0.42
7	Four or More Axle Single Unit Trucks	All trucks on a single frame with four or more axles.	0.42
8	Four or Less Axle Single Trailer Trucks	All vehicles with four or less axles consisting of two units, one of which is a tractor or straight truck power unit.	0.30
9	Five-Axle Single Trailer Trucks	All five-axle vehicles consisting of two units, one of which is a tractor or straight truck power unit.	1.20
10	Six or More Axle Single Trailer Trucks	All vehicles with six or more axles consisting of two units, one of which is a tractor or straight truck power unit.	0.93
11	Five or Less Axle Multi-Trailer Trucks	All vehicles with five or less axles consisting of three or more units, one of which is a tractor or straight truck power unit.	0.82
12	Six-Axle Multi-Trailer Trucks	All six-axle vehicles consisting of three or more units, one of which is a tractor or straight truck power unit.	1.06
13	Seven or More Axle Multi-Trailer Trucks	All vehicles with seven or more axles consisting of three or more units, one of which is a tractor or straight truck power unit.	1.39

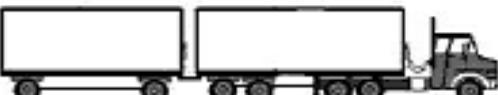
3.6a FHWA Vehicle Classifications

(1) Motorcycle 	(2) Passenger Car 	(3) Two Axle, 4-Tire Unit 	(4) Buses 	
(5) Two Axle, 6-Tire Unit 	(6) Three Axle Single Unit 	(7) Four or More Axles Unit 	(8) Three or four Axles Trailer 	
(9) Five Axle Single Trailer 		(10) Six or More Axles, Single Trailer 		 
(11) Five or Less Axles, Multi-Trailer 			(12) Six Axles, Multi-Trailer 	
(13) Seven or More Axles, Multi-Trailer 				

3.6b VEHICLE CLASSIFICATION VERSUS VEHICLE TYPE

Source: <http://www.fhwa.dot.gov/pavement/wim/pubs/if10018/tb02.cfm>

As used in this manual, vehicle classification refers to the identification of vehicles according to FHWA's 13 Class Scheme as described in the Traffic Monitoring Guide (<http://www.fhwa.dot.gov/ohim/tmguide/>). However, individual classes within this scheme include vehicles with different axle configurations and operating characteristics that need to be uniquely identified by a WIM system's classification algorithm. Additionally, the ability to perform analyses on vehicles with similar axle configurations and operating characteristics, regardless of FHWA classification, can be of great benefit in performing data analyses. Vehicle type is used to refer to vehicles with similar axle configurations and operating characteristics. A few examples of vehicle types follow.

Class 7 includes all trucks on a single-frame with four or more axles. For trucks with "variable load suspensions" or "lift axles" (as shown in Figure 8), only the axles in contact with the pavement are counted to determine classification.



Figure 8. Photo. Class 7, single-unit truck with four of its five axles in contact with pavement.

Class 8 includes several common three- and four-axle single-trailer configurations. Figure 9 displays a two-axle tractor with a single axle semi-trailer and Figure 10 displays a three-axle tractor with a single axle semi-trailer. For this method of defining a truck combination type, the first value is the number of axles on the power unit (tractor or straight truck), the "S" signifies a semi-trailer, and the following value is the number of axles on the trailer.



Figure 9. Photo. Class 8, Type 2S1.



Figure 10. Photo. Class 8, Type 3S1.

Class 9 includes five-axle single-trailer trucks. Figure 11 displays the three-axle tractor and two-axle semi-trailer, which is by far the most predominant Class 9 type. Figure 12 displays the same type but with a "spread" tandem on the trailer. If this axle spread exceeds eight feet it is not a true tandem axle and is considered to be two individual axles. Figure 13 displays a three-axle straight truck pulling a two-axle full trailer. As such, there is no "S" preceding the value defining the trailer's number of axles.



Figure 11. Photo. Class 9, Type 3S2.



Figure 12. Photo. Class 9, Type 3S2 with "spread" rear tandem.



Figure 13. Photo. Class 9, Type 3S2.

Class 10 includes six-axle single trailer trucks. Figure 14 displays the most common configuration, the Type 3S3 which has a semi-trailer with a tridem axle.



Figure 14. Photo. Class 10, Type 3S3.

Class 11 includes five-axle multi-trailer trucks. Figure 15 displays the most common configuration, the Type 2S12. The first value defines the number of axles on the power unit, the "S1" defines the single axle semi-trailer, and the last value defines the second trailer as a two-axle full trailer.



Figure 15. Photo. Class 11, Type 2S12.

Class 12 includes six-axle multi-trailer trucks. Figure 16 displays the most common configuration, the Type 3S12.



Figure 16. Photo. Class 12, Type 3S12.

Class 13 includes multi-trailer trucks with seven or more axles for which there are a large number of possible axle configurations. Although there are exceptions, most agencies do not find it necessary to uniquely define these by type since they account for a very low percentage of the truck traffic stream.

3.7 Layer Coefficients for Design

Date: 9/2018

Source: Pavement Design Section

New Asphalt	0.54
Existing Asphalt	0.24-0.35
Existing Bituminous Sand	0.2
Bituminous Millings	0.2
Cold-In-Place Recycle	0.25
Full Depth Reclamation w/PC or Fly Ash	0.25
Full Depth Reclamation w/water only	0.14
Hydrated Lime Slurry Stabilization	0.25
Foundation Course	0.2
Soil Aggregate Base Course	0.14
Lime or Fly Ash Stabilized Subgrade	0.22
Rubbilized Concrete	0.28-0.32

PCC does not have a layer coefficient. However, a value of 0.5-0.75 has been used by some researchers for comparison purposes only.

3.8 Pavement Condition Definitions

Source: State of Nebraska, Pavement Management Systems, 2018

International Roughness Index (IRI) *Smoothness Specification*

Definition: Measure of pavement roughness expressed in millimeters per meter.

Description	mm/m	in/mile
Very Smooth	0 – 0.85	0 - 53
Smooth	0.86 – 2.48	54 - 157
Moderately Rough	2.49 – 3.33	158 - 211
Rough	3.34 – 4.21	212 - 267
Very Rough	4.22+	267

IRI – Hot Mix Asphalt (HMA) - Resurfacing Projects: The Intent is to build or resurface the roadway with an IRI \leq 68 in/mile. All dips and bumps greater than 0.4” shall be corrected by diamond grinding. (Refer to Section 502 of Standard Specifications for Highway Construction for additional information.)

IRI - Portland Cement Concrete (PCC): The intent is to build a roadway with an IRI no greater than 99 in/mile. Surface deviation shall not exceed 0.3” if a profiler is used or 1/8” if a 10’ straight edge is used. (Refer to section 602 of the SSHC for additional information.)

Rutting

Definition: Average depth of displacement between wheel path and adjacent asphalt pavement.

Description	Ave. Rut Depths
Good	< 4 mm
Fair	4 to 9 mm
Poor	> 9 mm

Nebraska Serviceability Index (NSI)

Definition: Formulae based pavement rating which incorporates the following distresses:

Asphaltic Concrete: Cracking (longitudinal, transverse, wheel path, etc), failures, potholes, raveling, weathering, bleeding, and rutting.

Portland Cement Concrete: Joint condition (repairs, spalls, sealant, fault depth, etc.) and panel condition (repairs, spalls, cracking, fault depth, etc.)

Description	Range
Excellent (Pavement like new)	90 - 100
Good (Several years of service remaining)	70 - 90
Fair (Few years of service life remaining)	50 - 70
Poor (Candidate for rehabilitation)	30 - 50
Very Poor (Possible Replacement)	0 - 30

Faulting

Definition: Displacement between two adjacent concrete slabs, measured at the common joint.

Description	inches
Low	1/8 to 1/4
Moderate	1/4 to 1/2
High	\geq 1/2

Chapter 4: Pavement Strategy Summary

Date: 2018

Source: Varilek

4.1 Flexible Pavements

Resurfacing

Mill and Asphalt Overlay or Overlay

- Mill/Fill depths determined by project specifics
 - Existing lift types and thicknesses as well as overall depth of structure
 - Core condition to include stripping, breaks, bond to PCC, etc.
 - FWD data including pavement and subgrade modulus through back calculations
 - Design Standard (Maintenance vs. 3R) and design life
 - Budget
- Includes SuperPave mixes, dense graded, gap graded, and other specialty mixes (Ultra-Thin Bonded Wearing Course, SAFLEA, etc.)

Hot In Place Recycling (HIR)

- Can be used alone to rejuvenate surface or in conjunction with additional mill and overlay
- Wearing surface typically applied to HIR. Typically Hot Mix Asphalt (HMA) but can be armor coat on low volume roadways.
- Consists of very long train of trucks with alternating mill heads and propane burners
- Mix design by private lab, approved by M&R
- No QA/QC during field production, process controlled by method specification

Hydrated Lime Slurry Stabilization (HLSS)

- Used when cracking/stripping and depressed thermal cracks are present, sometimes even with moderate rutting as the lime does a good job of stiffening the binder/mix matrix
- FWD tests and cores must be taken to verify subgrades capability of supporting extremely heavy paving train, and thickness depth verification of project history
- Best candidates 6"+ inches of hot mix over SABC (soil aggregate base course)
- Process no closer than within 2" of SABC, leaving this to protect the SABC and leave a sealed surface to place HLSS upon (typically stripped at bottom)
- Equipment capable of processing 3"-5". 4" typical for NE.
- A 3" asphalt overlay is typical.
- Place overlay after 7 days cure time and prior to 28 days
- Generally 1.5% CSS-1 emulsion and 1.5% Lime Slurry
- Fog seal only to prevent moisture infiltration from imminent storm or to mitigate raveling
- Mix design by private lab, approved by M&R
- No QA/QC during field production, process controlled by method specification

Cold-In Place Recycling w/ High Float Emulsion (CIR w/HFE) (rarely used in Nebraska)

- Sensitive to environmental factors
- Used sparingly on existing asphaltic or bituminous sand pavements
- Replaced with CIR w/ Foamed Asphalt
- Recently revised to a controlled depth strategy (vs. original full depth) to eliminate incorporation of virgin granular subgrade requiring additional emulsion
- Restores old, dry, cracked bit sand or asphalt pavements
- Uses High Float Emulsion (HFE-300)
 - Cutter helps mix and rejuvenate existing material
- HFE is typically applied at 2.5 to 3%
- Designed with Marshall Stability and Retained Stability
- Mix design is done by a private lab and approved by M&R
- No QA/QC during field production, process controlled by method specification

Cold-in Place Recycling w/ Foamed Asphalt (CIR w/foam)

- Used to create a stable base when significant stripping, pavement distress, and/or significant patching is present.
- Typical overlay thickness is 3"
- Uses a PG binder. During the recycling process the binder is maintained at a minimum 300°F and water is injected causing a foaming action that expands. The expanded binder tacks the RAP together.
- Equipment & process similar to HLSS
- The recycling train equipment includes a scalping shaker, a crusher for reducing the oversized material from the shaker, a pug mill and a strike-off screed. This is followed by a padfoot roller, motor grader, pneumatic and steel rollers. Depending on the depth of the recycle a material transfer vehicle and paver may be used and padfoot/motor grader omitted.
- Designed with Marshall Stability and Retained Stability
- Mix Design is done by a private lab and approved by M&R.

Fly Ash Slurry Injection (rarely used in Nebraska)

- Candidates difficult to access because many thermal cracks don't have a continuous void.
- This process intends to address bituminous thermal cracks and is done in conjunction with a mill and overlay.
- The process involves drilling injection holes near the thermal crack and Fly Ash slurry is injected through the drilled hole to fill the void beneath the thermal crack.
- Injection is limited to ½" of pavement lift.
- The minimum 7-day unconfined compressive strength of the fly ash slurry is 400 psi.
- The fly ash mix design is submitted to M&R for approval.

Fly Ash or Cement Stabilized Bituminous

- Used when extreme cracking/stripping and depressed thermal cracks are present. May also resolve rutting problems. Primarily used when the pavement is basically gone, and when hydrated lime slurry stabilization cannot be performed due to the pavements lack of ability to support a paving train operation. Also used in conjunction with drains when poor subgrade conditions exist.
- Generally process full depth including approximately 1-3" of underlying subgrade soil, the equipment is generally capable of going 16 inches in depth.
- Typical overlay thickness is 3". A 4" overlay preferred and necessary in curves with a deflection angle less than 2°.
- Place overlay after 2 days and within 28 days; generally 8-12% fly ash or 3-5% PC with 4% water.
- 7 day moist cured strength, 24 hours room temperature drying prior to compressive tests. Target minimum 90 psi.
- Fog seal to protect and cure until overlaid.
- Mix design by NDOT.
- No QA/QC during field production, process controlled by method specification

Concrete Overlay

- Placement of concrete over bituminous pavement or composite
- Minimum 5" depth, 6-8" depth more common
- Often preceded by significant milling to minimize grade raise and shouldering
- Best candidates are thick HMA pavements with available detour

Maintenance

Microsurfacing (Slurry Seal)

- Emulsion and fine aggregates used to correct rutting on high traffic areas that need to be repaired quickly.

Chip Seal

- ¼"- ½" of oil and aggregate (limestone or expanded shale)

Armor Coat

- ¼"- ½" of oil and stone (sand and gravel)

Fog Seal

- Application of oil to seal surface

Crack Seal

- Application of hot pour sealant to prevent water infiltration through existing cracks

High Friction Surface Treatment

- Improves the coefficient of friction. Aggregate used is calcined bauxite. Epoxy polymer bonds the bauxite to the surface. Shot blasting is required on concrete surfaces.

Penetrating Concrete Sealer

- Sealer applied to concrete surface to prevent the infiltration of water and to slow alkali silica reaction

4.2 Rigid Pavements

Resurfacing

Concrete Overlay

- Placement of concrete over existing concrete
- Thin bonded overlays (2"-4") have had mixed results nationally and are not used in NE.
 - Concrete must be in relatively good shape and new joints must match existing joints.
- Thick unbonded overlays (5"+) more common. HMA bond breaker needed over existing exposed PCC to act independently. Joints are not matched.

Hot Mix Asphalt (HMA) Overlay

- Most common resurfacing of concrete pavement. 50yr concrete pavement design includes 4" AC overlay at yr 35.
- Typically 3" - 4" overlay required
- 1" leveling course typical to prevent bumps at concrete joints

SAFLEA - Stress Absorbing Fiberglass Layer with Emulsified Asphalt

- The intent is often to seal PCC against moisture or as a treatment for badly cracked bituminous surfaces
- It may reduce reflective cracking in bituminous pavements or reflective cracks and joints in PCC pavements, however this is still being evaluated.
- Chopped fiber glass strands are sandwiched between two layers of binder (bituminous layer composed of a combination of rapid setting polymer modified-asphalt emulsion), covered with armor coat aggregate and then overlaid with hot mix asphalt (HMA).

Crack and Seat (w/overlay)

- Existing concrete pavement is broken into approximate 3' panels (transverse direction) by truck mounted guillotine hammer. Small panels are then seated into existing subgrade by overweight single axle cart before a 3-4" overlay is applied.
- Multiple hairline fractures reduce reflective cracking of original joints through overlay and amount of concrete repair work needed
- Traffic is maintained throughout process
- Candidates must have good drainage.

Rubbilization (w/overlay)

- Concrete is reduced to a crushed concrete base by a resonant hammer
- Significant (5"+) overlay required to carry traffic
- Traffic must be detoured following rubbilization
- Best candidates are concrete pavement deteriorated past the point of rehabilitation by Crack and Seat or Overlay such as pavements with advanced ASR.
- Candidates must have good drainage.

Maintenance

Diamond Grind and Joint/Crack Seal

- Fine grinding of PCC to remove faulting followed by sealing.

Dowel Bar Retrofits

- Placement of dowels in existing plain PCC for load transfer to eliminate future faulting. Slots are cut into pavement at transverse joints, dowel bars placed, and slots filled with epoxy. Works well in good pavements, accelerates deterioration in bad (ASR) pavements.



2011 TxDOT Pavement Design Guide

4.3 Stabilized Subgrades

Subgrade Preparation

- Upper 6" of subgrade prepared for paving
- Topsoil is removed and subgrade scarified, mixed, shaped and compacted at proper moisture per plans and specifications (compaction requirements).

Subgrade Stabilization

- Pavers with tracks don't require stabilization, but delivery trucks cannot operate on granular material.
- Upper 6" of subgrade stabilized to support equipment
- Clay binder added to granular soils
- Mix design by M&R based on Soil Lab testing
- Clay binder added until following values achieved (approximately 12CY per Sta):
 - Typical values for estimation: 15% passing #200 (subgrade + binder) AC Laydown
 - Typical values for estimation: 18% passing #200 (subgrade + binder) PCC Slip forming
- Foundation course (bituminous millings or crushed concrete) pushed out ahead of paver often used as alternative to subgrade stabilization

Lime Stabilized Subgrade

- Upper 8" of subgrade stabilized for paving
- Typically used for soils with PI's over 20
- Used to significantly reduce PI and frost heave potential and to increase strength
- Expect approximate 10 fold increase in strength, typically around 200 psi
- Hydrated or pebble quick lime used
- Mix design by M&R based on Chemistry and Soil Lab testing
- Lime typically applied at 4 to 6% as determined by Eades and Grim test
- Moisture (soil + lime) determined by mix design, typically 3-6% over optimum (soil)
- No Field QA/QC. Modified soil can be tested to investigate lime application rate.

Fly Ash or Cement Stabilized Subgrade

- Upper 8" of subgrade stabilized for paving
- Use Class "C" Ash or Type I/II Cement
- Fly ash applied at a rate of 10 to 15%, typically 1% under optimum moisture
- Cement applied at a rate of 5 to 7%, typically 1% under optimum moisture
- Used on soils with PI's under 20, but not granular
- Used to increase strength and/or dry saturated soils with slight PI reduction
- Lab testing requires 7 day moist cured strength and 24 hours room temperature drying prior to compressive tests. Target 100-350 psi depending on soil and fly ash
- Mix design by M&R based on Soils and Chemistry Lab testing
- No Field QA/QC. Modified soil difficult to test for application rate or coring for compressive strength.

Chapter 5: Subgrade

5.1 Calculating Nebraska Group Index (NGI)

Date: review 2018

Source: Geotechnical Design Manual, Lindemann

Dynamic Testing of Nebraska Soils and Aggregates, G. Woolstrum, 1989

<http://onlinepubs.trb.org/Onlinepubs/trr/1990/1278/1278-004.pdf>

Use Charts 1 and 2 when less than 65% retained on the 200 sieve

Required Data:

- % Retained on #200 Sieve
- Liquid Limit (LL)
- Plastic Index (PI)

Sum the values from the vertical axes of charts 1 and 2 to obtain the NGI.

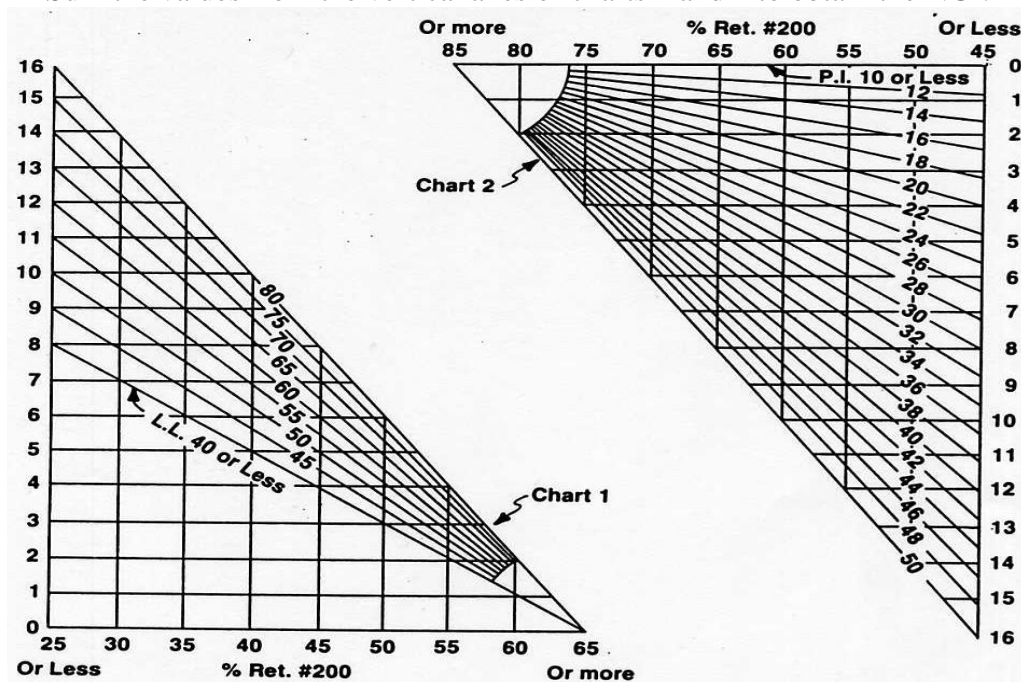

Use Chart 3 when greater than 65% retained on the 200 sieve wire

	Well Graded Gravel Base	Clean Coarse Sand	Clean Fine Sand	Loamy Coarse Sand	Loamy Fine Sand	Loamy Very Fine Sand
Group Index	- 4	- 3	- 2	- 1	0	
% Ret. #10	40 Min.					
% Ret. #40	60 Min.	35 Min.	34 Max.	35 Min.	34 Max. 10 Min.	9 Max.
% Ret. #200	85 Min.	85 Min.	85 Min.	84 Max. 65 Min.	84 Max. 65 Min.	84 Max. 65 Min.
P.I.	4 Max.	4 Max.	4 Max.	10 Max.	10 Max.	10 Max.

The first group from the left into which the test data will fit is the correct classification.

Chart 3. Granular Soils have a NGI of zero or less

5.2 Resilient Modulus of Soils Based on NGI

Date: 1989, review 2018, Lindemann

Source: *Resilient Modulus Testing of 14 Nebraska Soils*, R. Sneddon, 1988 and *Dynamic Testing of Nebraska Soils and Aggregates*, G. Woolstrum, 1989

<u>Soil Type</u>	<u>NGI</u>
Gravel	-2
Fine sand	-1 to 1
Sandy silt	2 to 7
Loess	8 to 12
Loess/till	13 to 14
Till	15 to 21
Shale/alluvium	22 to 24

Table 1 of Nebraska Group indices, NGI

Plasticity Chart (ASTM D2487)

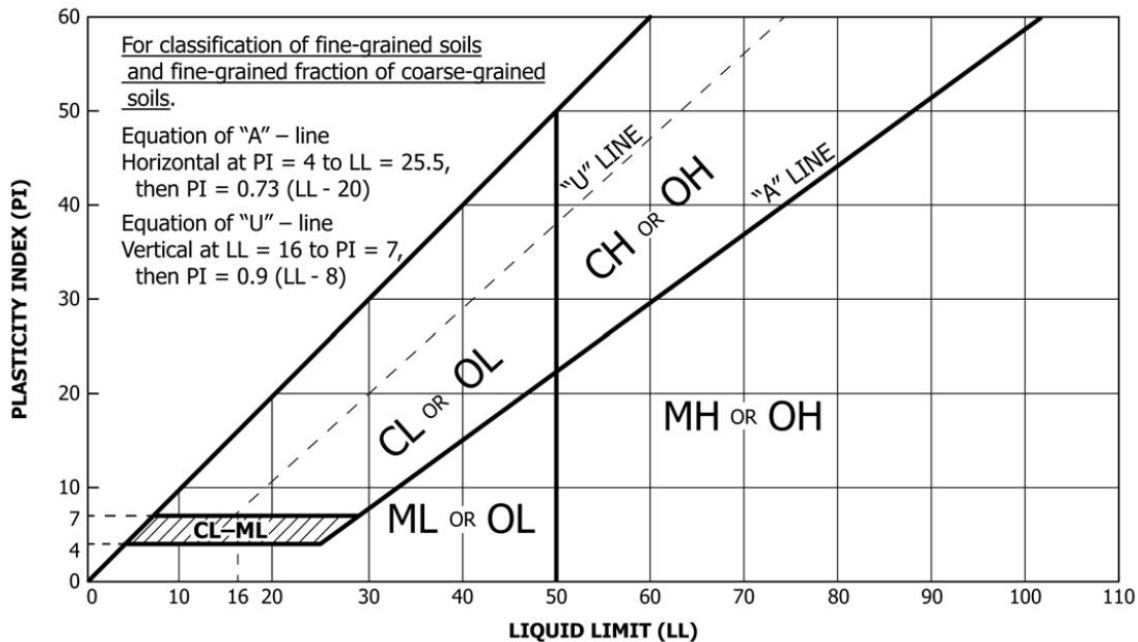

Fig 5.3 Plasticity Chart (ASTM D2487). The "A-line" separates silts from clays, while the "U-line" represents the upper limit of recorded test results. Data that plot above the U-line are probably in error. Note how the vertical axis is the plasticity index, not the plasticity limit. Soil identified as "non-plastic" (NP) are classified as ML or MH.

Note: During the soil mix design process, confirm that stabilizing the soil with lime does not move the soil into the MH – High Plasticity Silt portion of the chart. These soils are problematic. This can occur when a soil with a high shale content is stabilized with lime.

Table 2 of Nebraska Group Indices, NGI

<u>Group Index</u>		<u>Optimum</u>	<u>Wet</u>	<u>Dry</u>
-2		20500	20000	21000
-1		16400	12500	13600
0		14100	10300	12600
1		11200	7400	10300
2		6400	4000	5000
3		7200	4100	7300
4		5700	5000	6300
5		5300	2500	6100
6		5000	2300	5900
7		4600	2500	6100
8		6200	2100	8300
9		6500	3900	8700
10		7500	5000	6100
11		8700	6100	11400
12		9800	7100	12700
13		10900	8300	13000
14		11800	9500	14500
15		12500	10400	15000
16		13200	11200	15400
17		13600	12000	15500
18		13900	*12300	15200
19		13900	*12800	14800
20		13600	*12900	13900
21		13400	*12900	13500
22		12400	*11400	12800
23		11800	**9800	12100
24		10300	**8300	11400

* Though laboratory strengths are relatively high for wet conditions; in the field these strengths may be lower.

**These soils are very sensitive to moisture. Strengths may be much less.

Note: When the Group Index for soil is not known, the following M_R are used for design:

- (Fall) Optimum = 4,600
- (Spring) Wet = 2,100
- (Winter) Frozen = 20,000
- (Summer) Dry = 5,000

5.3 Subgrade Stabilization Agent Selection

Date: Review 2018
Source: Lindemann

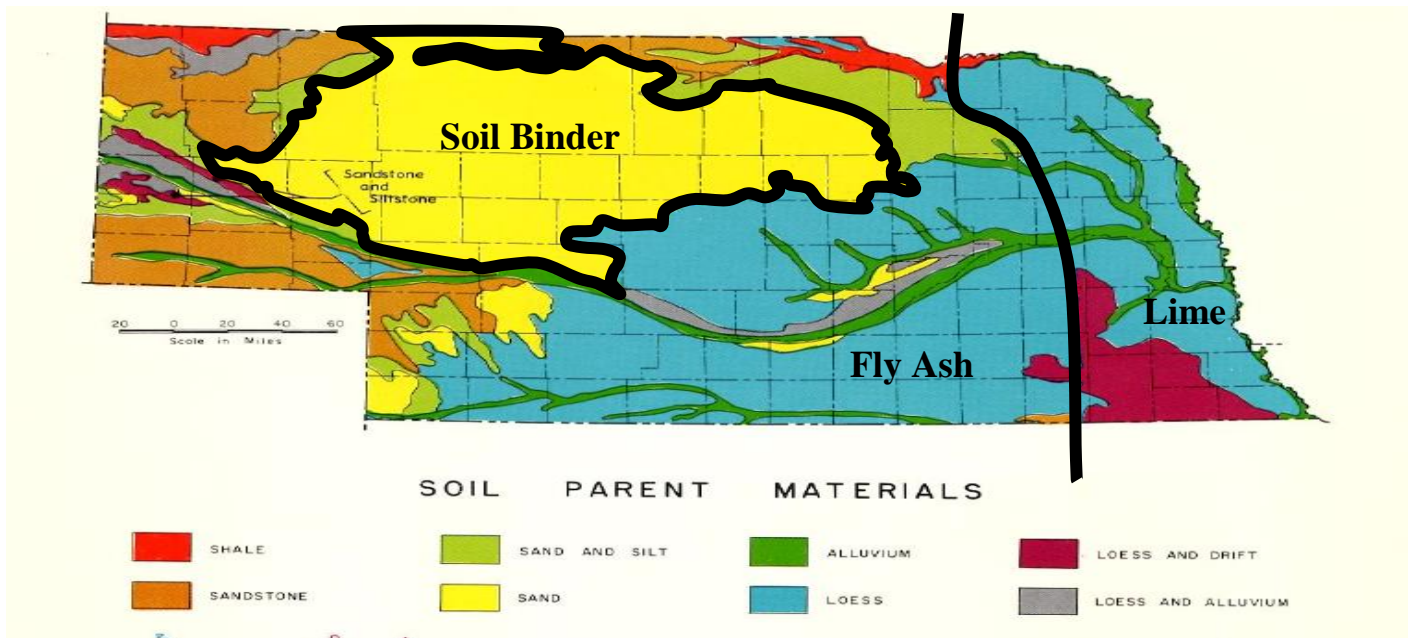

Above map shows general, statewide stabilizing agent use for reference only. Project specific agent selection and required percentage is detailed below.

- Agent Selection
 - PI < 16 use Fly Ash
 - PI 16-20 use Fly Ash* or Lime
 - PI > 20 use Lime
 - *Fly Ash more economical than Lime in NE.
 - Use Fly Ash for small or time sensitive projects (no cure period)
 - Use Fly Ash (10%) under temporary pavement when required (no mix design required)
 - In general, soils with a PI < 10 will not benefit from being stabilized. Samples with PI < 10 need to be evaluated for uniformity. The process of using a reclaimer improves uniformity, so rather than stopping and starting pulverization, continuity should be a consideration.
- Exact percentage of stabilizing agent determined through lab testing and M&R mix design. Typical percentages are:
 - Fly Ash: 10-15%
 - Lime: 3-6%

5.4 Plasticity Index Description

Date: review 2018, Lindemann
Source: Geotechnical Section

PLASTICITY INDEX

Liquid Limit = 40%

The liquid limit of a soil is that water content as determined by AASHTO T-89, at which the soil passes from a plastic to a liquid state.

Plastic Limit = 23%

The plastic limit of a soil is the lowest water content as determined by AASHTO T-90, at which the soil remains plastic.

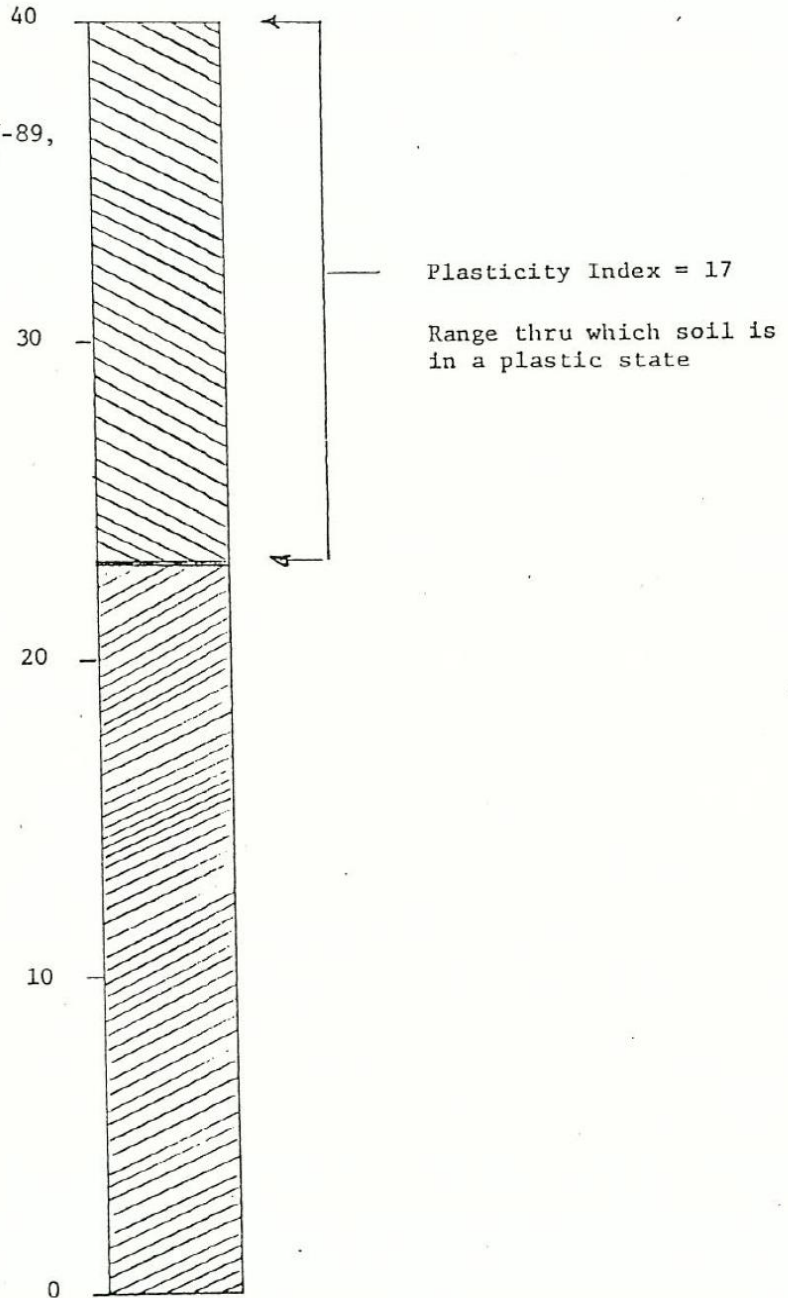

5.5 Soil Identification and Description

Date: review 2018, Lindemann
Source: Geotechnical Section

Unified Soil Classification System (USCS) of soil sample (Soil and Foundation Workshop Manual NHI # 13212, July 1993) System shall be used by the geotechnical section in order to provide uniformity in the description and classification of soil in the field.

Soil description classification and other information obtained during the subsurface exploration are greatly relied upon throughout the remainder of the investigation program and during the design and construction phase of a project. It is therefore necessary that the method of reporting this data be standardized. Records of subsurface explorations should follow as closely as possible the standardized format presented here.

A detailed description for each material stratum encountered should be included on the log. The description should be sufficiently detailed to provide the engineer with an understanding of the material present at the site.

Two terms that are used in the site exploration process are **IDENTIFY and DESCRIBE**. Identification is the process of determining which components exist in a particular soil sample, i.e., gravel, sand, silt, clay, etc. Description is the process of estimating the relative percentage of each component and preparing a word picture of the sample. Identification and description are accomplished primarily with vision and touch.

During the progression of a boring, the drilling personnel should roughly identify and describe the soils encountered.

A typical soil description procedure is shown on the following pages. This procedure involves visually and manually examining soil samples with respect to texture, plasticity and color. This method presented for preparing a word picture of a sample for entering on a subsurface exploration log applies to soil descriptions made in the field and laboratory.

DEFINITION OF TERMS FOR GENERAL SOILS

<u>Boulder</u>	A rock fragment, usually rounded by weathering or abrasion, with average dimension of 12 inches or more.
<u>Cobble</u>	A rock fragment usually rounded or sub rounded, with an average dimension between 3 to 12 inches.
<u>Gravel</u>	Rounded, sub rounded, or angular particles of rock that will pass a 3-inch square opening sieve and be retained on a Number 4 sieve.
<u>Sand</u>	Particles that will pass the Number 4 sieve and be retained on the Number 200 sieve.
<u>Silt</u>	Material passing the Number 200 sieve that is nonplastic and exhibits little or no strength when dried.
<u>Clay</u>	Material passing the 200 sieve that can be made to exhibit plasticity (putty like property) within a wide range of water contents and exhibits considerable dry strength.
<u>Fines</u>	The portion of a soil passing a Number 200 sieve.

- Muck Finely divided organic material containing various amounts of mineral soil.
- Peat Organic material in various stages of decomposition.
- Organic Clay Clay containing microscopic size organic matter. May contain shells and/or fibers.
- Organic Silt Silt containing microscopic size organic matter. May contain shells and/or fibers.
- Coarse – Grained Soil Soil having a predominance of gravel and/or sand.
- Fine – Grained Soil Soil having a predominance of silt and/or clay.
- Mixed – Grained Soil Soil having significant proportions of both fine – grained and coarse – grained sizes.

VISUAL – MANUAL IDENTIFICATION

- Gravel Identify by particle size. The particles may have an angular, rounded, or sub-rounded shape.
- Sand Identified by particle size. Gritty grains that can easily be seen and felt. No plasticity or cohesion. Size ranges between gravel and silt.
- Silt Identified by behavior. Fines that have no plasticity. Are difficult to roll into a thread and will easily crumble. Has no cohesion. When dry, can be easily broken by hand into powdery form.
- Clay Identified by behavior. Fines that are plastic and cohesive when in a moist or wet state. Can be rolled into a thin thread that will not crumble. When dry, forms hard lumps that cannot be readily broken by hand
- Muck Black or dark brown finely divided organic material mixed with various portions of sand, silt, and clay. May contain minor amounts of fibrous material such as roots, leaves, and sedges.
- Peat Black or dark brown plant remains. The visible plant remains range from coarse fibers to finely divided organic material.
- Organic Clay Dark gray clay with microscopic size organic material dispersed throughout. May contain shells and/or fibers. Has weak structure, which exhibits little resistance to kneading.
- Organic Silt Dark gray silt with microscopic size organic material dispersed throughout. May contain shells and/or fibers. Has weak structure, which exhibits little resistance to kneading.
- Fill Man-made deposits of natural soils and/or waste materials.

SOIL SAMPLE IDENTIFICATION PROCEDURE

- a) Is sample coarse-grained, fine-grained, mixed-grained or organic?
If mixed-grained, decide whether coarse-grained or fine-grained predominates.
- b) What is the principal component?
Use a noun in the soil description. i.e. Sand, Silt, Clay
- c) What is the secondary component?
Use as the adjective in the soil description. i.e. Silty Sand, Silty Clay, Clayey Silt
- d) Are there additional components?
Use as additional adjectives. i.e. Silty Sand Gravelly, Clayey Silt Sandy

EXAMPLES OF DESCRIPTIONS OF THE SOIL COMPONENTS

<u>Sand</u> -	Describes a sample that consists of <u>both</u> fine sand and coarse sand particles.
<u>Gravel</u> -	Describes a sample that consists of <u>both</u> fine and coarse gravel particles.
<u>Silty Fine Sand</u> -	Major component fine sand, with nonplastic fines.
<u>Sandy Gravel</u> -	Major component gravel size, with fine and coarse sand. May contain small amount of fines.
<u>Gravelly Sand</u> -	Major component sand, with gravel. May contain small amount of fines.
<u>Gravelly Sand, Silty</u> -	Major component sand, with gravel and nonplastic fines.
<u>Gravelly Sand, Clayey</u> -	Major component sand, with gravel and plastic fines.
<u>Sandy Gravel, Silty</u> -	Major component gravel size, with sand and nonplastic fines.
<u>Sandy Gravel, Clayey</u> -	Major component gravel size, with sand and plastic fines.
<u>Silty Gravel</u> -	Major component gravel size, with nonplastic fines. May contain sand.
<u>Clayey Gravel</u> -	Major component gravel size, with plastic fines. May contain sand and silt.
<u>Clayey Silt</u> -	Major component silt size, with sufficient clay to impart plasticity and considerable strength when dry.
<u>Silty Clay</u> -	Major component clay, with silt size. Higher degree of plasticity and higher dry strength than clayey silt.
<u>Fat Clay</u> -	Major compound clay with high degree of plasticity. Absorbs large amounts of water and can cause pavement distress due to shrink/swell characteristics.

OTHER INFORMATION FOR DESCRIBING SOILS

1. Color of the Sample - Brown, Gray, Red, Black, Yellow, Blue, Green, etc.
2. Moisture Condition - Dry, Moist, Wet. (Saturated)
3. Examples of Material - Sand, Silt, Clay, Gravel, Sandstone, Siltstone, Ironstone, Topsoil, Organic, Ogallala, Shale, Limestone, etc.
4. Examples of Descriptions - Slightly, Contains, Considerable, Decayed, Grains, Clean, Clayey, Silty, Fairly, Numerous, Fractured, Weathered, Trace, Eroded, Mottled, Cemented, Extremely, Intermittent, Compact, etc.

EXAMPLES OF COMPLETE SOIL DESCRIPTIONS

Light Gray Silty Clay, moist, plastic, with ½ inch layers of wet gray silt

Red Brown Clayey Silt, moist, plastic

Brown Silty fine Sand, wet, nonplastic

Gray Sandy Gravel, Clayey, moist, low plastic

Fill – Brown Sandy Gravel, with pieces of brick and cinders, wet, nonplastic

Dark Gray Organic Clay, with shells and roots, moist, plastic

DEFINITION OF TERMS FOR NEBRASKA SOILS

Topsoil -

Surface soil that supports vegetation. Usually, it is loamy and dark colored. Most generally described as brown silty clay.

Buried Topsoil – The remains of one-time surface soil buried under later deposits.

Redeposited Topsoil –

Is topsoil accumulated on terraces or bottomlands as colluvium washed down by sheet erosion from adjacent uplands.

Subsoil -

Usually, a compact zone resulting from the infiltration and accumulation of fines leached from the overlying topsoil. Most generally described as silty clay.

Claypan -

An extreme condition of the subsoil when, in areas with delayed runoff, a dense impervious clay layer develops.

Buried Subsoil –

The clay subsoil formed during a previous geologic age and now buried under later deposition.

Redeposited Subsoil –

The subsoil when eroded from its original position and deposited again at a lower elevation.

Peorian Loess (Silty Clay to Clayey Silt) –

A prevalent type of parent soil material in Nebraska, wind deposited materials that blanket much of eastern, central, and southwestern Nebraska. Exposed slopes in loess have a tendency to stand in a near vertical position. Settlement can be expected in Peorian, even if it is dry or wet. Embankment stability is usually good on dry peorian. Wet peorian may present stability problems requiring stage construction. The color is light brown to tan or light buff.

Redeposited Peorian –

Is loess that has eroded out of position as in talus at the toe of exposed loess slopes. In this condition, the vertical slope character of true loess is lost.

Sandy Peorian –

Describes loess mixed with sand as found in areas transitional between the sand hills and the typical Peorian mantle

Loveland Loess (Silty Clay) –

A loess older than Peorian having a distinguishing reddish tint and is usually heavier textured than the Peorian and can have varying amounts of sand. A buried solum occurs, occasionally, at the contact between Loveland and Peorian. This is often easily seen in fresh roadway cuts where the two are exposed.

Redeposited Loveland – Occurs when it has slumped out of its original position.

Sandy Loveland – A textural phase of Loveland.

Glacial Till (Silty Clay) –

Largely heavy clay soil with intermixed sand, rocks, and silt. It varies widely in color, but can usually be expected to contain some pebbles. For a general description the Kansan Till would be tan to orange in color, the Nebraskan Till would be gray.

Glacial Gravel – Made up of mixed sand, gravel, and boulders brought in by the glaciers.

Glacial Sand - Consists of local sand deposits associated with glacial till.

Fine Sand and Natural Sand –

These are wind-blown dune sands covering the sandhill area of the state and water deposited fine sands, wherever they may occur. The natural sand contains more fines than does the fine sand. Sand settles very little and settles very fast. Embankment stability is not a problem. Beware of areas where sand is on top of shale if the shale is not flat. Water may be trapped on the top of the shale.

Brule Clay (Silty Clay to Clayey Silt) –

Predominantly a massive compact pinkish silty clay. Occasionally, interbedded thin layers of volcanic ash are found. Brule can be found west of North Platte, it varies from all clay to varying percentages of clay, silt, and

sand. Settlement is minimal and embankment stability is good as long as it is dry. Erosion can be a problem. Can be sensitive to equipment traffic when wet and can become unstable.

Redeposited Brule –

Slumped and weathered Brule Formation. It is loose and mellow, very similar to loess in appearance and characteristics.

Ogallala Formation –

Predominantly a sand and gravel formation. Interbedded layers of sand, gravel, stones, lime, or a combination of these could be encountered. Ogallala can be found west of North Platte, it is most often cemented and varies from all sand and gravel to varying percentages of clay, silt, gravel, lime and sand. Settlement is minimal and embankment stability is good as long as it is dry. Erosion can be a problem

Pierre Shale (Silty Clay to Fat Clay) –

This formation is a dark gray massive clay, although it contains some chalk, bentonite, thin sandstones and may contain concretions. It is one of the most plastic clay soils, is a very poor subgrade material, and is conducive to slides on hillside locations. Most major slides in Nebraska have involved shale. The shear strength of shale is greatly reduced by increased moisture. Avoid adding fill on shale if previous slides are noted in the area. Benching a hillside prior to embankment construction is more important on shale. Shale typically has minimal settlement and poor embankment stability.

Carlile Shale –

Consists principally of gray shales containing a layer of fine-grained sandstone. It is not widespread at depths where it would be commonly encountered in Nebraska Highway construction.

Graneros Shale –

A dark gray plastic shale with some thin calcareous layers, sand and sandy shale, and coal like materials.

Dakota Sandstone and Dakota Shales –

Mainly of importance as a source of fine sand, this sand varies from loose clean fine or slightly coarse sand to highly cemented sandstone and “ironstone” requiring blasting or ripping to allow removal. The Dakota Shales are usually interbedded with the sands and are fine-grained silty clay shales, which generally have high swell characteristics, and are detrimental subgrade materials. They usually have a glossy or soapy appearance and are multicolored.

Alluvial Silts, Sands and Clays –

Water deposited material occupying the stream flood plains. Zonal developments may be missing and local variations in texture are denoted for Silt, Sand and Clay. Muck and Peat would also fall in this category. These soils have large settlements and poor embankment stability. They are usually saturated and pore pressure can present embankment stability problems. Two stage grading and/or wick drains work well in these soils. Surcharges may create a stability problem. If the layer is less than 10’ thick, excavation should be considered.

5.6 Current NDOT Compaction Requirements

(NDOT converted to LWD in 2015. Local Projects still has the option to use Percent Density from this chart.)

Date: Reviewed 2018, Lindemann

COMPACTION REQUIREMENTS

Project No. C.N. Project Name:

The following compaction requirements are recommended for the plans.

COMPACTION REQUIREMENTS

Class III (See Specifications)

	SOIL TYPE	DEPTH BELOW FINISH SUBGRADE	PERCENT DENSITY	MOISTURE REQUIREMENTS	
				MINIMUM	MAXIMUM
Embankment / Roadway Grading, including driveways, to receive concrete pavement	Silt-Clay	Upper 3 feet	98 Min.	Opt. -3%	Opt. +2%
	Silt-Clay	At depths greater than 3 feet	95 Min.	Opt. -3%	Opt. +2%
	Granular	All depths	100 Min.	**	**
Embankment / Roadway Grading, including driveways, to receive flexible pavement	Silt-Clay	Upper 3 feet	100 Min.	Opt. -2%	Opt. +1%
	Silt-Clay	At depths greater than 3 feet	95 Min.	Opt. -3%	Opt. +2%
	Granular	All depths	100 Min.	**	**
Embankment / Roadway Grading to receive gravel surfacing / crushed rock embedment	All	All depths	95 Min.	**	**
Embankment / Roadway Grading not to be surfaced	All	All depths	95 Min.	Opt. -3%	Opt. +2%

Subgrade Preparation, Shoulder Subgrade Preparation (Concrete Pavement)	Silt-Clay	The upper 6 inches of subgrade soil	98 Min.	Opt. -3%	Opt. +2%
	Granular	The upper 6 inches of subgrade soil	100 Min.	**	**
Subgrade Preparation, Shoulder Subgrade Preparation (Flexible Pavement)	Silt-Clay	The upper 6 inches of subgrade soil	100 Min.	Opt. -2%	Opt. +1%
	Granular	The upper 6 inches of subgrade soil	100 Min.	**	**

Embankment of driveways which are not to be surfaced	All	All depths	Class I	(See Specifications)	
Bituminous Pavement Patching	All	Underlying Material	100 Min.	(See Specifications)	
Foundation Course / Subgrade Stabilization	--	--	100 Min.	(See Specifications)	

Granular Structural Fill (MSE Walls, Granular Fill for bridges, Culverts, etc)	Granular	All depths	100 Min.	Opt. -3%	Opt. +3%

** Moisture as necessary to obtain density.

(A moisture target value at maximum density shall be established in the field by the Contractor during the compaction process. The acceptable moisture content shall be $\pm 2\%$ of the target value.)

(This template is just one of 20)

Chapter 6: Concrete

6.1 Current Concrete Mixes

Date: 9/2018

Source: NDOT Standard Spec. for Construction

Table 1002.02 SSHC (12-2017)

Class of Concrete (1)	Base Cement Type	Total Cementitious Material Min. lb/cy	Total Aggregate Min. lb/cy	Total Aggregate Max. lb/cy	Air Content % Min.-Max. (2)	Ledge Rock (%)	Water/Cement Ratio Max. (3)	Required Strength Min. psi
47B**	IP/IT*	564	2850	3150	6.5-9.0	-	0.45	3500
47B***		564	2850	3150	6.0-8.5	-	0.45	3500
47BD		658	2500	3000	6.0-8.5	30+3	0.42	4000
47B-HE		752	2500	3000	6.0-8.5	30±3	0.40	3500
BX ⁽⁴⁾		564	2850	3150	6.0-8.5	-	0.45	3500
47B-OL****		564	2850	3200	5.0-7.0	30±3	0.36	4000
PR1	I/II	752	2500	2950	6.0-8.5	30±3	0.36	3500
PR3	III	799	2500	2950	6.0-8.5	30±3	0.45	3500
SF ⁽⁵⁾	I/II	589	2850	3200	6.0-8.5	50±3	0.36	4000

(1) Each class of concrete shall identify the minimum strength requirement, per the contract. For example, where the last four digits indicate the psi. In the table above, strength of 3,500 psi is indicated for 47B-3500; however, other strengths may be authorized elsewhere in the contract. The classes shown in the chart are typical examples.

All classes of concrete shall be air-entrained and a water-reducing admixture shall be used per manufacturer's recommendations.

• Class R Combined Aggregate shall use a mid-range water reducer admixture. The dosage shall be at the manufacturer's recommendation and the Engineer may approve a low-range water reducer admixture.

(2) As determined by ASTM C 138 or ASTM C 231.

FOR INFORMATION ONLY. The Contractor may develop a Quality Control Program to check the quantity of air content on any given project; such as, checking the air content behind the paver.

(3) The Contractor is responsible to adjust the water/cement ratio so that the concrete supplied achieves the required compressive strength without exceeding the maximum water/cement ratio. The minimum water/cement ratio for any slip form concrete pavement is 0.38, unless the Contractor requests approval from the Engineer in writing to change the minimum water/cement ratio to 0.36.

(4) For temporary surfacing, Type I/II cement is allowed.

(5) Minimum Portland Cement shall be 564 lbs/cyds and the total Silica Fume added shall be 25 lbs/cyds.

(*) Refer to Subsection 1004.02 for material characteristics.

Lithium Nitrate may be used in place of Supplemental Cementitious Materials (SCMs), see Section 1007 of the Standard Specifications.

(**) For slip form applications.

(***) For hand-pours and substructures applications.

(****) When IP using Class N pozzolan, the maximum water/cement ratio is 0.41.

6.2 Historical Concrete Mixes

Date: review 2018

Source: Halsey

- **47B Traditional Mix:**
Before 2014
Was is defined as an IP(25) cement, 70% Class B Aggregate (limestone, coarse agg.) and 30% Class E Aggregate (sand & gravel, fine agg)
- **47B Current Mix:**
After 2014
Requires a Combined Total Aggregate Class R and Concrete Mix Design Submittals.
Spec. Book Table 1002.02 and Table 1033.03 C, D, & E (2017)

NDOR CEMENTS SPECIFICATIONS TIMELINE

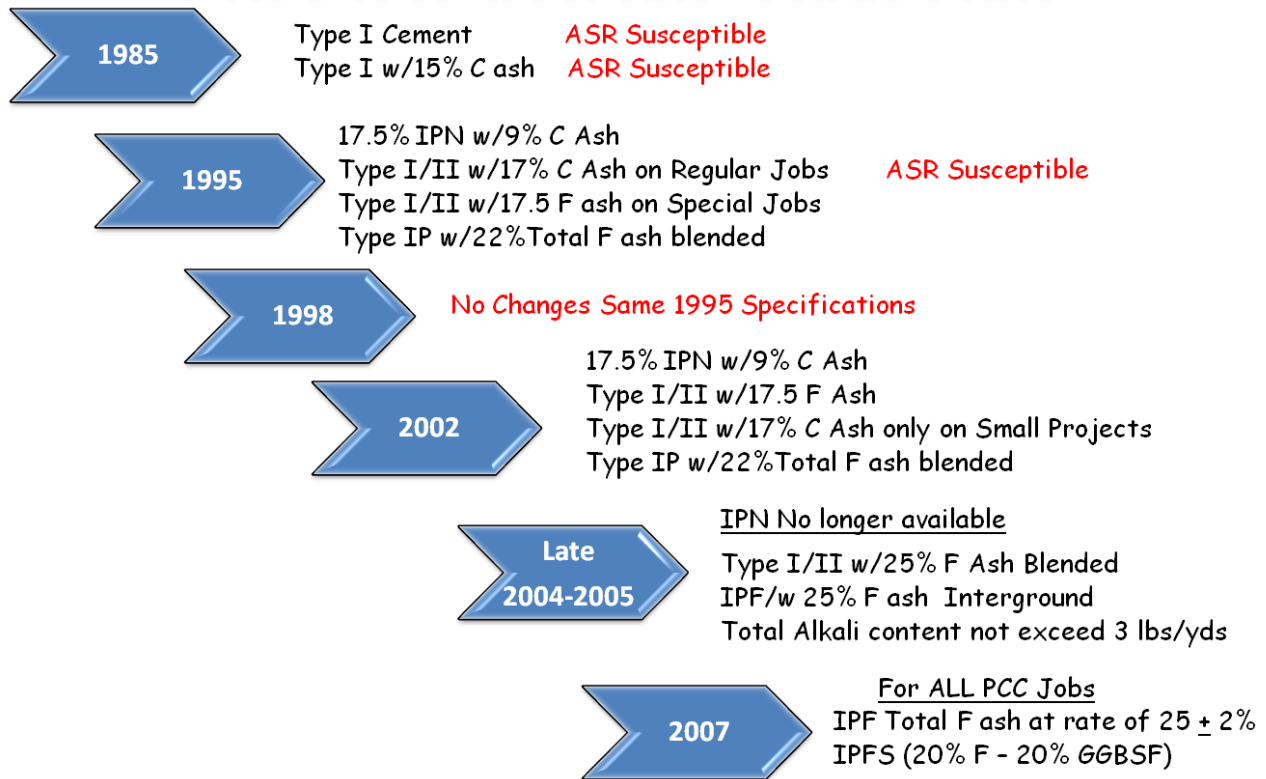

Notes:

When the “Brand and Type of Cement” is listed as “Holnam-Ideal HM” or “Holcim”, assume that it is Type IP/IPF with 22% F Ash blended at plant.

1995 – 17.5% IPN w/9% Fly Ash – may be listed as AL I/II, Ashgrove or Louisville, see specs to confirm.

6.3 Evaluation of Potential ASR

Date: 2018
Source: Heyen

(<http://www.fhwa.dot.gov/publications/research/infrastructure/pavements/pccp/03047/02.cfm>)







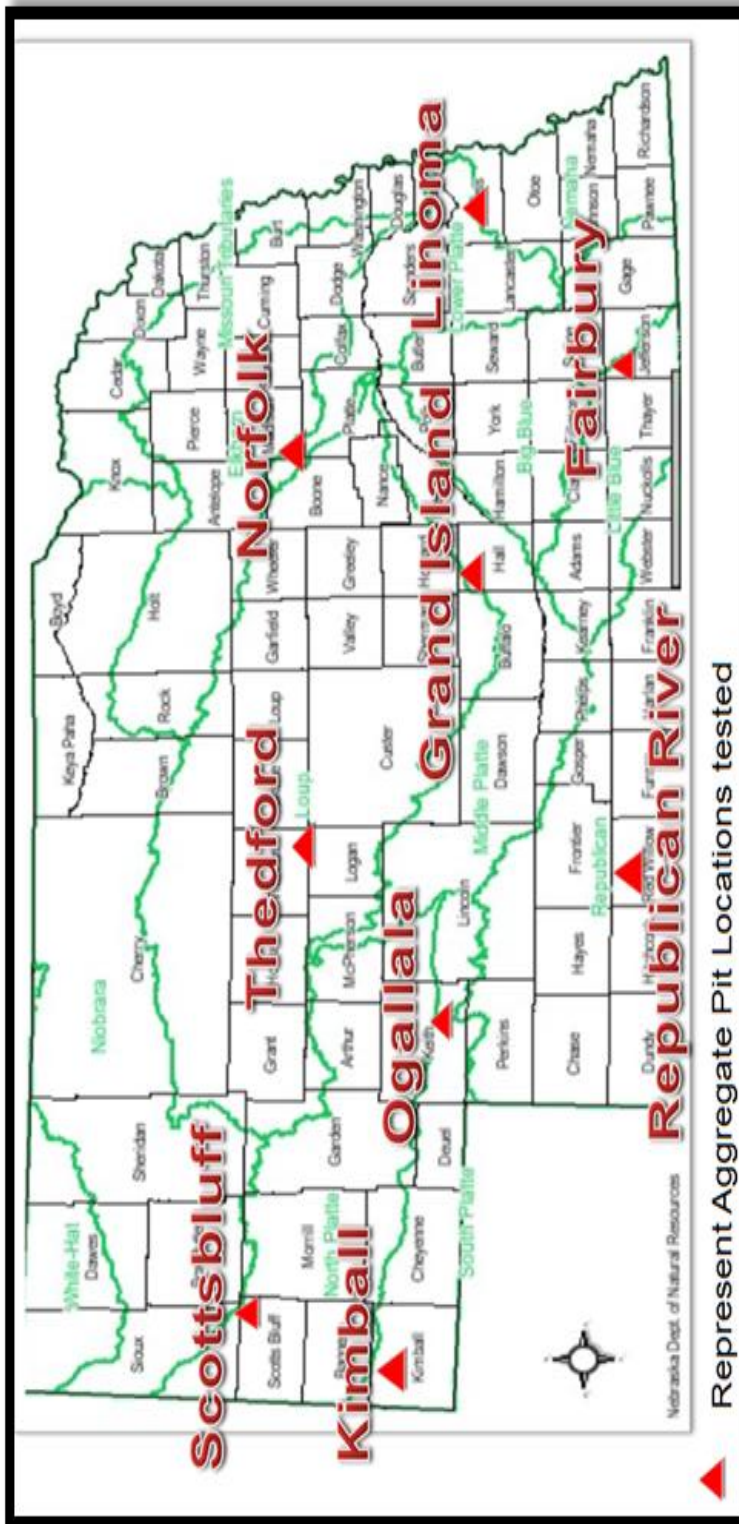

The mechanism of ASR is described as certain aggregates containing reactive forms of silica in the aggregate (e.g. chert, quartzite, opal, and strained quartz crystals) that react with potassium, sodium, and calcium hydroxide from the cement to form a gel around the reacting aggregate particles. When this gel is exposed to moisture, it expands, creating forces that cause tension cracks to form around the aggregate. Once cracking has initiated, more moisture penetrates the concrete, thus accelerating ASR. The ASR evaluation is based on the standard test methods for potential Alkali Reactivity of Aggregates- ASTM C 1260 and ASTM C 1567. ASTM C 1260 determines and characterizes the reactivity of the aggregates within 28 days according to NDOT specifications and ASTM C 1567 determines the mitigation of ASR with the use of supplemental cementitious materials (SCM).

Steps to Evaluate Concrete Susceptibility to ASR in Existing PCC (2013 Halsey/Heyen)

1. Drive Pathweb to identify any ASR staining and/or cracking.
2. Investigate the history of projects for the roadway. Gather the as-built plans, specifications and archived documents.
3. Based on the special provisions and the proportion report determine:
 - a. Type of cement
 - b. The percentage and type of fly ash used
 - c. The percentage of natural pozzolans that was used
 - d. The maximum cement alkali content that was permitted (lb/yd³)
4. If the special provisions or specifications do not match the cement used on the project, verify whether there were change orders related to cement.
5. Based on the project location determine the likely watershed source for the sand and gravel (Figure 1), then find the watershed source (aggregate location) in the first column of Table 1.
6. Compare the minimum replacement level of SCM (supplementary cementitious material) to the level of SCM used to build the roadway. The alkalinity of Nebraska's Type I or II cement is 0.6% Na₂O_{eq} or less. According to AASHTO PP 65 cement alkalis less than 0.7% Na₂O_{eq} allow the reduction of SCM by one prevention level or 5 to 10%. The green column in Table 1 shows the appropriate percent replacement of cement with fly ash type F for Nebraska's cements.
7. Optional: Once a pavement has been identified as having the potential for ASR, testing of core samples can be done to verify that ASR exists. The test procedure is known as "Standard Method of Test for Rapid Identification of Alkali-Silica Reaction Products in Concrete" (AASHTO Designation: T 299-93 (2009)). The sample is treated with Uranyl Acetate and signs of ASR fluoresce under black light.



**Figure 1. Nebraska's Regions –
Aggregate Reactivity Study – December 2012**

Aggregate Type Location	Description of Aggregate Reactivity	(Table 6-AASHTO PP 65-10)	Type I/II Cement Low Alkalinity	Nebraska's Spec Since Late 2004 IP with 25% Class F
		Min. Replacement Level of SCM	Min. Replacement Level of SCM Mitigate ASR	
Platte River Grand Island	Moderately Reactive	20	15	
Dry Pit Kimball	Highly Reactive	25	20	
Republican River Indianola	Very Highly Reactive	35	25	
North Platte River Scottsbluff	Highly Reactive	25	20	
South Platte River Ogallala	Moderately Reactive	20	15	
Middle Loup River Thedford	Highly Reactive	25	20	
Little Blue River Fairbury	Moderately Reactive	20	15	
Elkhorn River Norfolk	Very Highly Reactive	35	25	
Platte River Linoma	Highly Reactive	25	20	

Non-Approved Aggregate

Table 1. Minimum SCM for Nebraska Aggregates

Typical Chemical Composition of Fly Ash (2013, Halsey/Heyen)

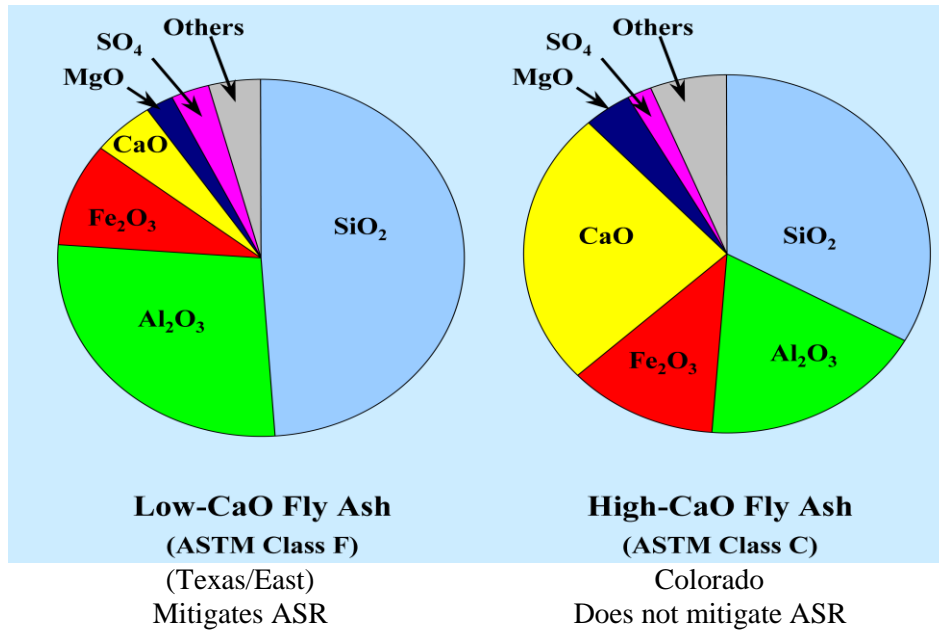

Note: Actual composition varies greatly, depending on the source.

Chemical Composition of GGBF Slag

There is a much smaller range in the chemical composition of commercially available slags. Despite the wide range in composition, slag from a given source tends to be of consistent composition.

Oxide	Range
SiO ₂	32-42
Al ₂ O ₃	7-16
CaO	32-45
MgO	5-15
SiO ₂	0.7-2.2
Fe ₂ O ₃	0.1-1.5
MnO	0.2-1.0

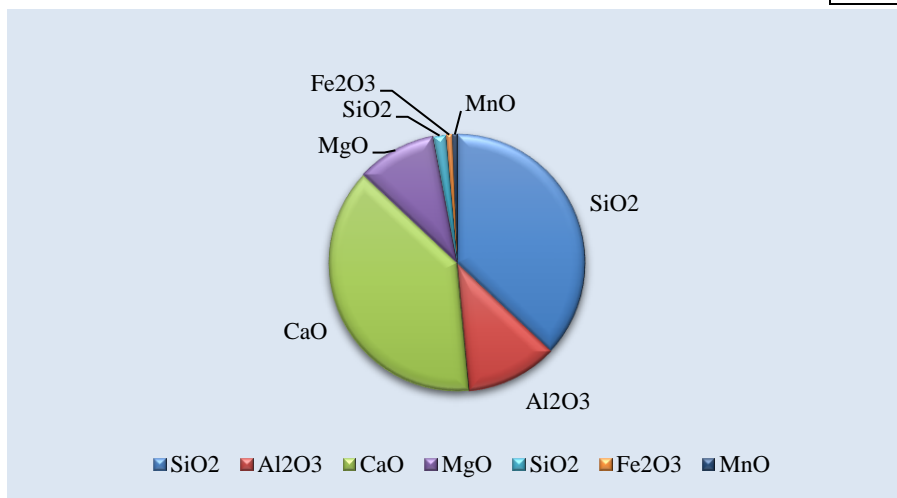

Fly Ash - General Notes

- Fly ash, slag, silica fume, natural pozzolans, and lithium admixtures are all effective at controlling ASR provided they are used in sufficient quantity.
- The equivalent alkali in cement is defined as the sum of sodium oxide (Na₂O) and potassium oxide (K₂O) and expressed as sodium oxide equivalent alkali: $Na_2O_{eq} = Na_2O + 0.658 K_2O$.
- Type I/II cement without SCMs or Type I/II with Fly Ash Type C- ASR susceptible. Moderately Reactive Aggregate may develop ASR slowly.
- Type I/II cement with 17% Fly Ash Type F – Effective at mitigating ASR in moderately reactive aggregate, the development of ASR may be slow for Highly and Very Highly Reactive Aggregate.
- Type IPN cement 17.5% and 9% Fly Ash Type C – Effective at mitigating ASR in Moderately Reactive Aggregate, the development of ASR may be slow for Highly and Very Highly Reactive Aggregate.
- Type IP cement with 22% Fly Ash Type F - Effective at mitigating ASR for all but Very Highly Reactive Aggregate.
- Type I/II cement with low alkalinity and no SCMs – ASR susceptible but deterioration may be slow with Moderately Reactive Aggregate.
- Type IP cement- In Nebraska, the Fly Ash was exclusively Type F at 25% since 2007.

FHWA Protocol for Preventing ASR (power point presentation)

http://www.ibracon.org.br/eventos/52cbc/fournier_ raa.pdf

source: <\\dotfs\MR\In-House Research\Presentations\2017 NC2 Salt Lake City>

Supplier Acceptance Requirements **Interground/Blended Cement**

- **The supplier shall conform to ASTM C 595**
 - NDOR verifies the chemical and physical composition of the final Interground/Blended Cement
 - NDOR pre-establish (CaO/SiO₂) ratio
- **Supplier provides the Alkali Silica Reaction (ASR) testing**
 - (ASTM C 1567 less than 0.10% @ 28 days)
 - Platte River and Norfolk aggregate
 - NDOR verify ASTM C 1567
- **Total Cement Replacement with SCM's**
 - 20% min
 - 40% max

6.4 Joint Design Example

Date: 2018

Source: Pavement Design

Roundabout Guidance

1. A non-doweled expansion joint is required between the circulatory roadway and the truck apron.
2. The maximum slab dimension is 16'-6".
3. Avoid joint angles less than 60 degrees.
4. Longitudinal joints are tied. Provide Pavement Design with Joint Layout Details one month prior to PS&E turn-in.

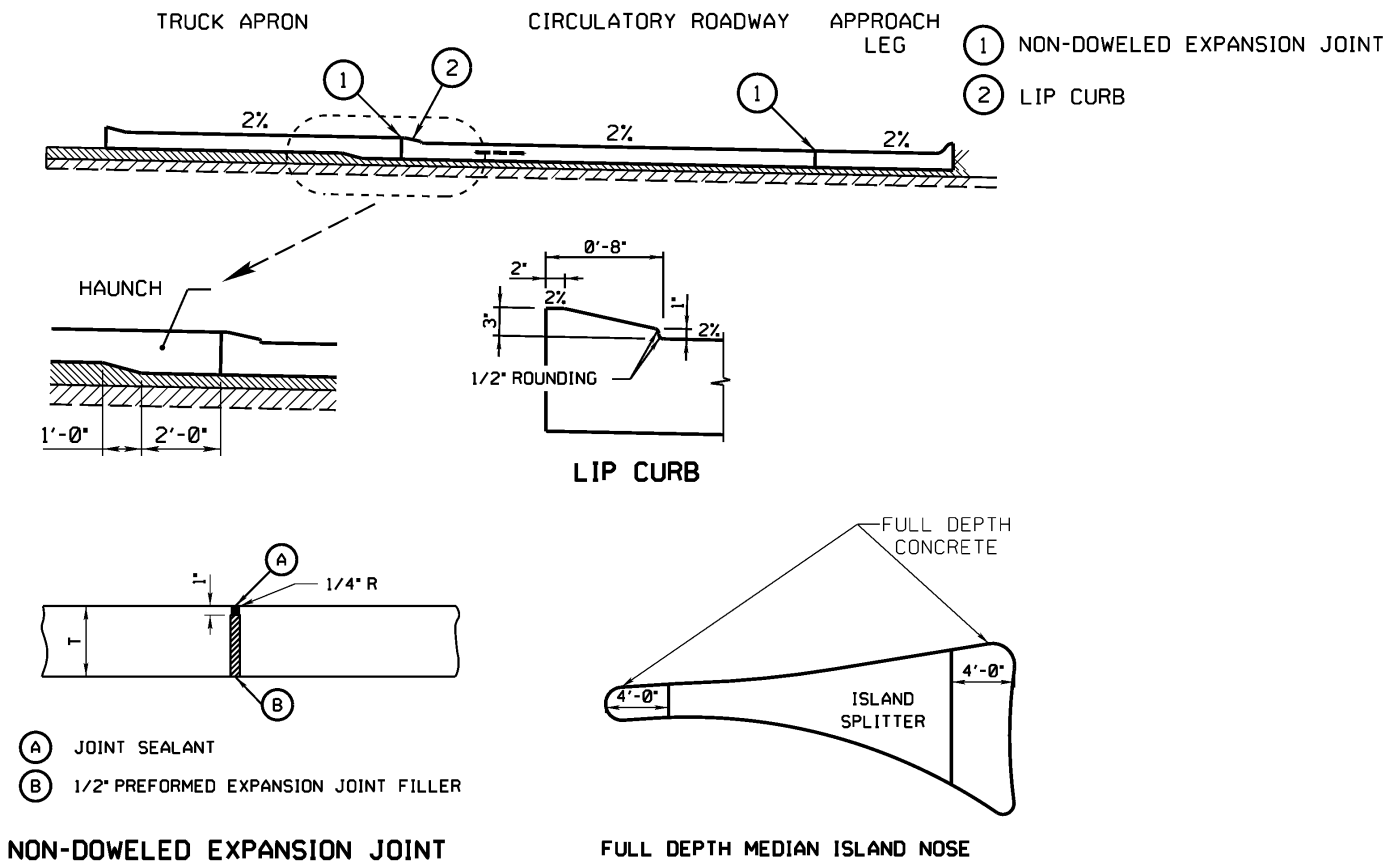

Figure 3: Roundabout Details

Roundabout Background info.: <https://www.fhwa.dot.gov/publications/research/safety/00067/000676.pdf>

6.5 Area of Steel Calculation

Date: 11/17/04

Source: A mechanistic-Empirical tie Bar Design Approach for Concrete Pavements, <http://www.acpa.org>

Current Tie Bar Design Practice

The most commonly cited basis for tie bar design in the United States is the subgrade drag theory, or SDT. This theory, which has its origins in the design of steel reinforcement for slab-on-grade concrete flooring, is explained in several textbooks and industry references (Yoder & Witczak, 1975; Huang, 1993; PCA, 2008). The SDT method of design is based on the concept of providing sufficient steel to allow the “dragging” of the concrete slab across the base course without yielding the steel or pulling out the tie bars. The basic concepts are as follows:

1. The maximum force a tie bar can sustain without yielding, F_{TB} (lb), is expressed as:

$$F_{TB} = a_s * f_s \quad (1a)$$

where

- a_s = cross-sectional area of one tie bar, in²
 f_s = the allowable stress in steel f_s , lb/in² (usually taken as two-thirds of the yield strength)

2. The force to drag a concrete slab across the base course, F_{drag} (lb), is computed as

$$F_{drag} = L_{slab} D_{fe} H_{PCC} W F \quad (1b)$$

where:

- L_{slab} = slab length, in
 D_{fe} = distance to the closest free edge, in

- H_{PCC} = concrete slab thickness, in
 W = unit weight of concrete, lb/in³ (approximately 0.0868 lb/in³ for a typical paving concrete mixture).
 F = coefficient of friction at the slab-base interface (e.g., a value of 1.5 for unbound bases is recommended by the 1993 AASHTO *Guide for Design of Pavement Structures* or simply the 1993 AASHTO Guide)

3. If n is taken as the number of tie bars per slab length, then the equation of equilibrium of the SDT is:

$$nF_{TB} = F_{drag} \quad (2a)$$

4. From equation (2a), the total area of steel per slab can be determined as:

$$n\alpha_s = A_s = \frac{L_{slab} D_{te} H_{PCC} W F}{f_s} \quad (2b)$$

where A_s (in²) = total area of steel for a given slab length.

5. The required tie bar spacing, J_{TB} (in), can be determined as:

$$J_{TB} = \frac{L_{slab} \alpha_s}{A_s} \quad (2c)$$

Example Application of the SDT Method for Tie Bar Design

Problem statement:

Compute the total area of steel (A_s) required for a 12-in concrete slab with a 15-ft transverse joint spacing over an unbound base for a highway consisting of two 12-ft lanes tied at the centerline joint. Assume Grade 60 steel (steel yield strength, $f_y = 60,000$ psi). Also compute the tie bar spacing required for #4 deformed bars. Assume the unbound base coefficient of friction to be 1.5.

Solution:

Area of steel calculation (variables previously defined)

$$A_s = L_{slab} \cdot D_{te} \cdot H_{PCC} \cdot W \cdot F / [f_y \cdot (2/3)]$$

$$A_s = [180 \text{ in} \cdot 144 \text{ in} \cdot 12 \text{ in} \cdot 0.0868 \text{ lb/in}^3 \cdot 1.5] / [60,000 \text{ psi} \cdot (2/3)]$$

$$= 1.01 \text{ in}^2$$

Tie bar spacing calculation:

The area of a #4 bar is 0.20 in². Thus, and using equation (2c), a maximum spacing of 35.6 in should be used to drag the concrete slab over the unbound base course and while keeping the steel stress safely below its yield stress. This could practically translate to providing 6 #4 bars per slab at a 30 in spacing.

6.6 Area of Steel Calculation - Example: Interstate Lanes + Shoulder

Date: 2018
By: Barrett

- A_s = Area of Steel = $(L_{\text{Slab}} \times D_{\text{fc}} \times H_{\text{pcc}} \times W \times F) / (f_y \times \frac{2}{3})$
 L_{Slab} = Length, in
 D_{fc} = Closest Width to free edge, in
 H_{pcc} = Thickness, in
 W = Unit Weight, lb/in^3
 F = Coefficient of Friction, 1.5 for unbound
 f_y = Yield Strength of Steel, psi
 η = No. of tiebars per slab length

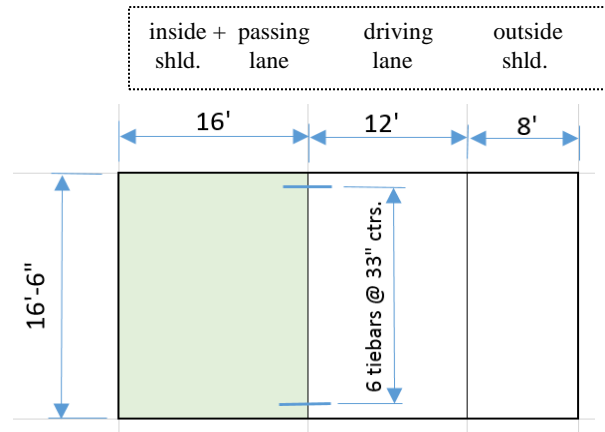

- L_{slab} = $16'-6'' = 198''$
 W_{slab} = $16'-0'' = 192''$
 t_{slab} = $12''$ ($>10''$, use #6 bars)
 a_s = actual bar area, #6 = $\pi (\frac{3}{4} / 2)^2 = 0.4418 \text{ in}^2$
 W = $0.0868 \text{ lb}/\text{in}^3$
 F = 1.5
 f_y = $40,000$

$$A_s = \frac{(L_{\text{Slab}} \times D_{\text{fc}} \times H_{\text{pcc}} \times W \times F)}{(f_y \times \frac{2}{3})} = \frac{(198'')(192'')(12'')(0.0868 \text{ lb}/\text{in}^3)(1.5)}{(40,000)(\frac{2}{3})} = 2.23 \text{ in}^2$$

$$\eta = \frac{A_s}{a_s} = \frac{2.23 \text{ in}^2}{0.4418 \text{ in}^2} = 5.05 \text{ tiebars} \rightarrow \text{NDOT uses 6 tiebars}$$

Required tie bar spacing:

$$J_{\text{TH}} = \frac{198''(0.4418)}{2.23} = 39.3'' \text{ spacing} \rightarrow \text{NDOT uses 33'' spacing}$$

Chapter 7: Asphalt and Asphalt Binders

7.1 Historical Asphalt Mixes

Date: 2018
Source: Byre

<u>TYPE</u>	<u>DESCRIPTION/USE</u>
11	Mix is designed to have a crushed value of 80% for the combined mineral aggregate, with a maximum of 60% limestone for skid resistance and a 75 blow Marshall design and a target field air void of 4.0%. For use on high volume road with a truck count of 350 or more.
11R	Mix is identical to the type 11 except that a recycled asphalt pavement (RAP) is used to supplement the virgin aggregate. All properties are the same as that of the type 11.
13	Mix is designed to have a crushed value of 80% and composed of a minimum of 50% quartzite or granite and a 75 blow Marshall design and a target field air void of 4.0%. Used on high volume roads usually capping a type 11 and urban projects when placing 2-2 1/2 inches.
13R	Mix is identical to the type 13 except that a (RAP) is used to supplement the virgin aggregate. All properties are the same as that of the type 13.
14	Mix is designed to have a crushed value of 60% for the combined mineral aggregate, with a maximum of 60% limestone for skid resistance and a 50 blow Marshall design and a target field air void of 4.0%. Used on medium volume roads with truck traffic between 125 and 350.
14R	Mix is identical to type 14 except that a (RAP) is used to supplement the virgin aggregate. All properties are the same as that of the type 14.
17	Mix is designed to have a crushed value of 0% for the combined mineral aggregate, a maximum of 60% limestone for skid resistance and a 50 blow Marshall design and a target field air void of 3.5%. Used for shoulders off the Interstate and Expressway system.
17C	This mix is designed to have a crushed value of 20% or 40% for the combined mineral aggregate, with a maximum of 60% limestone for skid resistance and a 50 blow Marshall design and a target field air void of 3.5%. The 20% is used for shoulders on interstate and expressways. The 40% is used for mainline under traffic with 125 trucks or less.
17R	Mix is identical to type 17 except that a (RAP) material is used to supplement the virgin aggregate. All properties are the same as that of the type 17.
17RC	Mix is identical to the type 17C, 20% or 40% except that a (RAP) material is used to supplement the virgin aggregate. All properties are the same as that of the type 17C.
1	Mix is composed of a combined mineral aggregate of not less than 50% crushed rock, crushed mineral aggregates which contain no more than 15% naturally occurring fine retained on the 10 sieve, 60% maximum limestone permitted. Used for the same type of projects as type 11.

- 1R Mix is identical to type 1 except that a (RAP) material is used to supplement the virgin aggregate. Used in the same type of projects as type 11.
- 3 Mix is composed of crushed quartzite or granite and mineral filler if required. Used for the same type of projects as type 13.
- 3R Mix is identical to type 3 except that a (RAP) material is used to supplement the virgin aggregate. Used in the same type of projects as type 13.
- 4 Mix is composed of not less than 30% crushed rock, crushed mineral aggregates which contain no more than 20% naturally occurring fine aggregates retained on the No. 10 sieve and mineral filler if required, 60% max. limestone permitted. Used for the same type of projects as type 14.
- 4R Mix is identical to type 4 except that a (RAP) material is used to supplement the virgin aggregate. Used in the same type of projects as type 14.
- 7 Mix is composed of a combined mineral aggregate, 60% maximum limestone permitted. Used for the same type of projects as type 17.
- 7R Mix is identical to type 7 except that a (RAP) material is used to supplement the virgin aggregate. Used in the same type of projects as type 17.
- II Mix is composed of mineral aggregate No. 2-A, mineral aggregate No. 5 (fine sand) and mineral filler.
- IIR Mix is identical to type II except that a (RAP) material is used to supplement virgin aggregate.
- A Mix is composed of crushed rock, mineral filler and 3-A crushed sand gravel. It was used as both a base and surface course.
- A Special Mix is composed of crushed rock, mineral filler and 3-A crushed sand gravel. It was used as a base course. The gradation of the crushed rock was slightly coarser and the percentage content of crushed rock in the mix higher than the A mix.
- AX Mix is composed of crushed rock, fly ash and mineral aggregate. It was used as both a base and surface course on the interstate.
- AX Special Mix is composed of the same material as type AX only this mix has a higher percentage of crushed rock. It was used as a base course on the Interstate.
- Q This mix is composed of crushed quartzite or crushed granite. It was used as a surface layer on the Interstate.
- RQ Mix is identical to type Q except that a (RAP) material is used to supplement the virgin aggregate. Used on same type of projects as Q.
- MQ This is an open graded mix composed of quartzite or granite gravel sand aggregate and mineral filler. Used on the surface layer of the Interstate.

CC, CC1 & CC2

Mixes are composed of crushed concrete, 3-A sand and mineral filler.

- RCC** Mix is composed of (RAP), approximately 82% crushed concrete and 18% 3-A sand gravel. Used as a base course on the Interstate.
- RAX** Mix is identical to the type AX except that it has a RAP material added to supplement the virgin aggregate. Used where type AX could be used.
- RAX Special** Mix is identical to the type AX Special except that it has a RAP material added to supplement the virgin aggregate. Used where type AX Special could be used.
- SMA** Experimental European Mixture Stone Mastic Asphalt composed of crushed rock, 3A crushed sand gravel and mineral filler. Used on high traffic volume roads.
- GGCRM** Gap Graded Crumb Rubber Modified mix. Placed as a surface mix, usually 1.5” to 2.5” in thickness. This has the resemblance of a SMA (Stone Mastic Asphalt) mix. It is a high binder, rut and crack resistant surface. Used on high volume roadways.
- GGCRMLV** Gap Graded Crumb Rubber Modified Low Volume mix. Placed as a surface mix, usually 1.5” to 2.5” in thickness. This has the resemblance of a SMA (Stone Mastic Asphalt) mix. It is a high binder, rut and crack resistant surface. Used on low to medium volume roadways.
- RLC** Used as a leveling course for HLSS, FDR, and overlay projects. It has the same gradation as an “LC” but uses standard PG binder types and contents, and targets regular mainline volumetrics.
- OGFC-CRM** Open Graded Friction Course mix. Placed as a surface mix, usually 1” to 1.5” in thickness. This is coarser than a regular OGFC and contains higher binder amounts. This mix uses 58-28 binder that is modified with crumb rubber. Provides a high friction, drained and quiet pavement section. Used on mainline roadways and ramps.
- HRB** High Rap Base mix. It is a very fine graded, single aggregate mix used in lower lifts only. It contains a minimum 25% or 35% RAP as specified and a maximum 50% RAP. The mix contains no lime and a minimum 5.5% of PG 64-22 (64-34 as of 2010) binder. It is a very stiff mix used on low to medium volume roadways. HRB was constructed for approximately 2 seasons before being replaced with SPR.
- SPL** Static Pressure Loading mix is a well graded Marshall mix. There is a fine mix and a course mix. The mixes are used primarily for camper pads, parking lots, lower lifts, and temporary pavement. RAP is not required but often needed to achieve the required 230 psi bearing capacity. It contains no lime and a minimum 5.2% of PG 64-22 (64-34 as of 2010) binder. SPL has been replaced with SPR.
- SUPERPAVE** Mix design system for specifying asphalt binders and mineral aggregates, developing and analyzing asphalt mixtures and establishing pavement performance prediction, based on cumulative equivalent single axle loads.

SP1, SP2, SP3, SP4 & SP5

These mixes were designed for a range of different traffic loads (SP1 for the lowest, SP5 for the highest.) All mixes were designed using SuperPave criteria including: CAA, FAA, gyrations to achieve 4% air voids in the lab, elongated pieces, clay content, VMA, VFA, binder content and dust to asphalt ratio. SP1 thru SP3 had a history of rutting, in some cases. Eventually, only SP4, SP4 Special & SP5 were used. SP5 was used on roadways with ≥ 750 trucks per day.

SPR Fine This mix meets the requirements of SPR except that the gradation allowed greater variance making it easier to include additional RAP. The variance in gradation gave the contractor more control based on how the asphalt was placed. Often this mix was placed in lift thicknesses less than 1.5 inches as a leveling course and was still capable of being used in intermediate or top lifts on the same project.

SP4 Special This mix meets the requirements of SP4 except the gyratory effort to meet target air voids was reduced. This mix was intended for use on Roadways with lower truck volumes than SP4.

LC, SPS, SPR, SPH, SLX, SRM - Current Hot Mix Asphalt Designs (see Sec 3.2)

7.2 Asphalt Binders/Emulsions

Date: 2018
Source: Byre

Emulsions

- Water and asphaltic oil mixture
- Allows work at lower temperature and easier mixing
- Emulsion “breaks” when water is driven off (turns from brown to black)
- Anionic (negative charge) or cationic (positive charge) used in NE
- Emulsions can be rapid, medium or slow set

<u>Work Description</u>	<u>Grade</u>	<u>Type</u>
Armor Coat or Chip Seal	CRS-2, RS-2, CRS-2L, CRS-2P, HFE-150, HFMS-2L, CRS-2VHL, HFMS-2P	Modified and Non-Polymer
Bituminous Sand Base Course	MC CUTBACK, HFE-300, CMS-1	Non-Polymer
Cold In-Place Recycling	HFE-300	Non-Polymer
Fog Seal	CFS-1, FS-1, CSS-1H, SS-1H	Non-Polymer
Hot In-Place Recycling	ARA	Polymer Modified
Hydrated Lime Slurry Stabilization	SS-1, SS-1H, CFS-1, FS-1, CSS-1, CSS1-H	Non-Polymer
Microsurfacing	CQS-1H	Polymer Modified
Scrub Seal	CRS-2P	Polymer Modified
Tack Coat	SS-1, SS-1H, CSS-1, CSS-1H, CFS-1, FS-1	Non-Polymer

CFS – Cationic Fast Set

CRS - Cationic Rapid Set

CSS - Cationic Slow Set

HFE - High Float Emulsion

Trailing Number 1 = low relative viscosity
 2 = high relative viscosity

Trailing letters H = Hard
 P = Polymer Modified Emulsion
 L = Latex

Chapter 8: Maintenance using Hot Pour Sealants

Date: 2018
Source: Byre

AC & PCC SEALING CALENDAR WORK SCHEDULE

The following is a list of pavement maintenance treatments and the time of year in which the work is typically performed. Use as a guide to select the proper letting date for a project.

CONCRETE

Type of Work	Done Between
Sealing joints	4-1 to 11-30
Sealing cracks	4-1 to 11-30

ASPHALT

Type of Work	Done Between
**Crack sealing bituminous surface	11-1 to 3-31
Joint Sealing, Asphalt to Concrete	11-1 to 3-31

Type of Work & When it is Done			
**Fog Seal	Armor Coat or Chip Seal	Micro-surfacing	Slurry Seal
6-1 to 9-1	6-1 to 9-15	6-1 to 9-15	6-1 to 9-15

**On some projects both Fog Sealing and Crack Sealing Bituminous Surface are specified. For these projects, a late spring or early summer letting is recommended to be able to complete the fog seal by late summer (6-1 to 9-1) and then the crack sealing in the winter (11-1 to 3-31).

Sealant Descriptions

CR-18B

- Contains about 18% crumb rubber. Is a thinner, more adhesive sealer with “healing” properties. Best used for asphalt applications. Good for transverse or longitudinal cracks and able to get into smaller cracks.

NE-101

- Vary similar to CR-18B for uses; however, has only 10-15% crumb rubber and uses more polymers. Typically, a little more expensive since more additives. It is a thinner, more adhesive sealer with “healing” properties. Best used for asphalt applications. Good for transverse or longitudinal cracks and able to get into smaller cracks.

NE-3405

- Similar to both the CR-18B & NE-101, but does not have the flexibility requirements in the specification. This is because no crumb rubber is required. This is not recommended for longitudinal cracks or joints. It should only be used for transverse joints.

NE-3405LM

- Basically NE-3405 with addition of soft polymers. Designed for climates typically colder than Nebraska. Some NDOT maintenance yards prefer using it. Used in identical applications as NE-3405, but cost vs. need should be factored in, as NE-3405LM typically runs 27% more in price than NE-3405.

See approved product list @ <http://www.nebraskatransportation.org/mat-n-tests/hotpoursealers.htm>

Sealant Selection Chart

	NE-101	NE-CR18B	NE-3405	NE-3405LM
Bituminous Pavement				
Crack	X	X	X	X
Best when majority of cracks are longitudinal. (Tracking and Pullout issues)	X	X		
Selection by crack width dimension. (Routing is recommended for cracks up to 3/8", rout to 1/2" wide x 3/4"-1" deep)	< 3/8"	≥ 3/8"	< 1/2" routing is required	< 1/2" routing is required

Concrete Pavement				
Cracks and Joints			X	X
For all cracks > 1/4" wide, remove old crack sealer and all foreign material by sand and air blasting. Full depth of edge surfaces need to be dry and clean.				
Longitudinal Joint of Mainline to Bituminous Shoulder		X		

Viscosity: Low = thin, High = thick	Medium	Med-High	med. - low	low
-------------------------------------	--------	----------	------------	-----

Chapter 9: Cost and Quantity Estimates

9.1 Estimated Costs Per Mile (Asphalt)

Date: 2018, Debutts

2018 Estimated Costs Per Mile

1/12/2018

Note: Costs include a 1.32 factor E&C

Asphalt Types LC, SPH, SRM, SPR, w/ PG Binder (58V-34) Shoulders are SPS w/PG (58S-34)

No.		Cost/Mile
1.	4 " x 24' Hydrated Lime Slurry w/3" SPR	\$335K
	4 " HLSS w/Trenched Widening & 3" SPR (28' top)	\$362K
2.	Class 3 Mill 1 1/2" x 24', Place 2" SPR	\$146K
3.	Class 1 Mill x 24', Place 4" SPR	\$281K
4.	Class 3 Mill 2" x 24', Place 4" SPR	\$287K
5.	Class 3 Mill 4" x 24', Place 4"SPR	\$268K
5a.	Class 3 Mill 4" x 24', Place 6" SPR	\$409K
6.	10" x 24' Fly Ash Stabilized bituminous w/3" SPR	\$343K
7.	Dowel Bar Retrofit & Diamond grind driving lanes, then joint seal (14' width one direction)	\$219K
8.	Interstate-30' ML: Mill 4", Place 4" SPH 7' Outside Shld: Mill 1.5", Place 1.5" SPS	\$364K
9.	New Build 24' SPR on Stabilized Subgrade, Type Lime	6" thick \$518K 8" thick \$623K 9" thick \$740K 10" thick \$740K
10.	New Build 30' Dowelled PCC (includes 4' F.C., Prep, 6" surf shld, construction)	8" thick \$1137K 9" thick \$1161K 10" thick \$1184K 12" thick \$1346K 14" thick \$1393K
11.	Class 3 Mill 4" x 24' , Place 4" SPR&1" SLX & Trenched Widening	\$418K
12.	5" x 24' Cold In-Place Recycling with foam asphalt, paver laid	\$90K
13.	White Topping 5" x 24' Non-Doweled PCC (no special traffic control or bond breaker included)	\$397K
14.	Hot In-Place Recycling 24' & Armor Coat (\$25K/mile)	\$127K

15. Class 3 Mill 1" x 24' , Hot In-Place 2", Place 1.5" SPR	\$210K
16. ML & Inside Shld 27' Mill 2" place 1 3/8" SPH over 5/8" LC	\$177K
17. Class 3 Mill 4" x 24' Place 4" SRM & 1" SLX	\$331K
18. Class 3 Mill 4" x 24' Place 4" SRM & 2" SPR	\$383K
19. High Friction Surface Treatment (1-Layer) 24' wide	\$388K
High Friction Surface Treatment (2-Layer) 24' wide	\$874K
20. 3" x 24' SPR over 1"LC	\$74K
Crack & Seat PCC = \$0.35/sy Rubblize PCC = \$2.50/sy Sub Prep = \$1.60/sy, & \$340/sta Stab Sub = \$2.70/sy, & \$725/sta Fnd Course = \$5.00/sy Granular Subdrains = \$135/each 4" Perf. Pipe Underdrain = \$8.00/lf PG Binder (58V-34) = \$500/ton (58S-34) = \$460/ton (58H-34) = \$550/ton	

Additional Items		cost/mile
A. Shoulder Overlay with SPS 16' wide	1" thick	\$36K
	2" thick	\$71K
	3" thick	\$107K
	4" thick	\$142K
	5" thick	\$178K
	6" thick	\$213K
B. Shoulder Fog Seal 16' wide		\$3.5K
C. Shoulders Armor Coat 16' wide		\$19.5k
D. Trench Widen 6" (2@2') & fill with recycle, Place 3" SPR		\$41K
E. Trench Widen 4" (2@2') & fill with SPR, Place 4" SPR		\$84K
F. Cold Milling, Class 3 x 24'	1" deep	\$17K
	2" deep	\$20K
	3" deep	\$23K
	4" deep	\$26K
	5" deep	\$33K
	6" deep	\$37K
G. Diamond Grind 12' wide		\$28K
Concrete Surface Mill 1" x 24'		\$48K
Concrete Pavement Repair, Flexible Polymer Modified \$560/sy		
H. Non-Woven Pavement Overlay Fabric 24' wide		\$47K
I. 6" Shoulder Surfacing 5' wide		\$107K
J. Interstate Concrete Shoulders 10' & 4' wide	5" thick	\$323K
	6" thick	\$334K
	7" thick	\$356K
	8" thick	\$377K
	9" thick	\$388K
	10" thick	\$399K
	12" thick	\$475K
	14" thick	\$497K
K. SPR overlay 24' wide	1" thick	\$84K
	2" thick	\$139K
	3" thick	\$200K
	4" thick	\$254K
	5" thick	\$313K
	6" thick	\$375K
L. SRM overlay 24' wide		\$217K

9.2 Preventative Maintenance Costs Per Mile

Date: 2018
Source: Debutts

Preventative Maintenance Jan-18 Cost per Mile includes: Traffic Control, Mobilization, Contingency and Construction Engineering		
Description	Cost / Mile	Cost / Lane Mile
Class 1 Milling - 24' Roadway	\$16,400	\$8,200
SAFLEA Armor Coat - 24' Roadway (Does not include Class 1 Milling)	\$38,500	\$19,250
Armor Coat - 24' Roadway (Does not include Class 1 Milling)	\$28,800	\$14,400
Asphalt Overlay - Mill 3/4" x 24' Roadway with 3/4" Overlay	\$78,800	\$39,400
Chip Seal - 24' Roadway	\$33,400	\$16,700
Chip Seal - Light Weight Aggregate (expanded shale)- 24' Roadway	\$43,000	\$21,500
Crack Sealing - 8 Mile x 24' Roadway	\$12,900	\$6,450
Diamond Grinding & Concrete Repair - 24' Roadway	\$113,000	\$56,500
Fog Seal - 24' Roadway	\$6,000	\$3,000
Fog Seal - 16' (2 - 8' Shoulders)	\$4,000	\$2,000
Fog Seal - 40' (24' Roadway & 8' Shoulders)	\$9,900	\$4,950
Microsurfacing - 24' (1/4" Rut)	\$54,000	\$27,000
Microsurfacing - 24' (1/2" Rut)	\$69,000	\$34,500
Microsurfacing - 24' (3/4" Rut)	\$83,000	\$41,500

9.3 Concrete Repair Costs

Date: 10/2018
Source: Bouwens

ESTIMATED COST FOR CONCRETE REHABILITATION (1.32% E & C AND FCR IS INCLUDED PER MILE, 24' WIDE)

CONCRETE PAVEMENT (TYPES A, B AND C) AND JOINT REPAIR, FULL DEPTH (2 lanes per mile, cu. Yds.)

1. Existing (Plain/Reinforced) Concrete w/ASR (Built 1984 - 2005) = \$ 100,000
(After viewing Pathway and bad condition, use \$200,000)
2. Existing (Plain) Concrete w/little or no ASR (Built before 1984) = \$75,000
3. Concrete (Plain) w/existing AC Overlay = \$50,000 (\$75,000 Interstate)
4. Concrete (Reinforced) w/existing AC Overlay = \$66,000 (\$80,000 Interstate)
5. Crack & Seated Concrete w/existing AC Overlay = \$50,000

DIAMOND GRINDING AND TEXTURING CONCRETE PAVEMENT (sq. vds.)

1. Concrete with 2 lanes and AC shoulders = \$52,000
2. Concrete with 2 lanes and Concrete Shoulders = \$56,000
3. Concrete with 4 lanes and Concrete Shoulders = \$30K (Driving Lane Only/mile) or x 2= \$60K
4. Concrete with 4 lanes and AC Shoulders = \$28 (Driving Lane Only/mile) or x 2 = \$56K

JOINT SEALING – ASPHALT TO CONCRETE (INTERSPLICE) (by Station)

1. Concrete with AC Shoulders on 2 lane or 4 lane, 2 shoulder joints counted = \$8,400

SEALING JOINTS (Lin. Ft.)

1. Concrete with 2 lanes and AC Shoulders = \$20,000
2. Concrete with 2 lanes and 8' Concrete Shoulders = \$43,000
3. Concrete with 4 lanes and 10' Concrete Outside/3' Inside Shoulders = \$84,000

SEALING CRACKS (CONCRETE PAVEMENT)

1. After viewing Pathway, if not a huge amount of longitudinal cracking is present, use an average of 500'/mile = \$1,815

CRACK SEALING BITUMINOUS SURFACING (Lin. Ft.)

1. This is a total “guesstimate” until cracks are actually counted in field = **\$11,000**

EXAMPLE: Concrete Repair, Grind and Seal

\$75,000 (Plain concrete pavement repair)

\$30,000 (Grinding driving lane/1’ passing lane/1’ outside shoulder)

\$ 1,815 (Sealing cracks)

\$84,000 (Sealing 2 longitudinal joints/skewed transverse joints/3’ & 10’ shoulders)

\$190,815 / mile

E & C = Engineering & Contingencies

FCR = Foundation Course Replacement

CONCRETE CURB REPAIR - \$50/lin. Ft.

9.4 Estimating Quantities Worksheet

Date: 2018
Source: Debutts

Sheet 1 of 9 3/20/18

Estimating Quantities in English & Metric Reference to 2017 NDOT Standard Specifications for Highway Construction

General Information:

Items are listed in alphabetical order.
Conversion factors are in English and Metric.
R.A.P. is an acronym for Recycled Asphalt Pavement other term used Bituminous Millings.
Weight of RAP – 144 lbs/ft³
One gallon of emulsified asphalt or water weighs 8.333 lbs.
Beveled edges in asphalt and concrete pavements are subsidiary. The required material is included in asphalt tons or concrete square yards.

Asphaltic concrete projects. Add the following equipment rental items and hours.

"Rental of Loader, Fully Operated" – 15 Hour
"Rental of Motor Grader, Fully Operated" – 15 Hour
"Rental of Dump Truck, Fully Operated" – 15 Hour
"Rental of Skid Loader, Fully Operated" – 15 Hour

Armor Coat – Section 515

"Armor Coat Aggregate" – Cubic Yard (cubic meter)	23 lb/yd ² 14.1 kg/m ²	conversion factor 1.3 tons = 1 yd ² conversion factor 1.54 Mg = 1 m ²
"Armor Coat Emulsified Asphalt" – Gallon (kiloliters)	0.34 Gall/yd ² (0.9 L/m ²)	

Asphaltic Concrete – Section 503, Section 1028 & Special Provision

"Asphaltic Concrete, Type "____" – Ton (megagram) Tables on pages 6 & 7 for types and weight
Include material required for beveled edge
"Hydrated Lime/WMA" – Each Table on page 6
"RAP Incentive Payment" – Each Asphaltic Concrete Type "____" tons x 1.7 = Each

Asphaltic Concrete Curb – Section 505

"Constructing Asphaltic Concrete Curb" – Linear Foot (meter)	
Factor for 3" (75 mm) Curb	1.35 Tn/Sta (4.0 Mg/Sta)
Factor for 4" (100mm) Curb	2.00 Tn/Sta (6.0 Mg/Sta)
Factor for 6" (150mm) Curb	2.10 Tn/Sta (6.25 Mg/Sta)
Factor for Tack Coat	1.0 Gals/Sta (4 L/Sta)

Asphaltic Concrete For Patching – Section 516

"Asphaltic Concrete for Patching, Type "____" – Ton (megagram)

Asphalt Pavement Smoothness Testing ID – Mile - Section 502 & Special Provision

Bituminous Patching of Concrete Pavement – Section 520

"Bituminous Patching" – Ton (megagram)

Bituminous Sand Base Course – Section 509

"Bituminous Sand Base Course Asphaltic Oil" – Gallon (liter)	1000 Gal/Sta for (5' x 24') [12400 L/Sta for (130 mm x 7.3 m)]
"Bituminous Sand Base Course Emulsified Asphalt" – Gallon (liter)	1200 Gal/Sta for (5' x 24') 6% residual [14900 L/Sta for (130 mm x 7.3 m) (6%)]
"Bituminous Sand Base Course" – Station	
"Mineral Filler for Bituminous Sand Base Course – Cubic Yard (cubic meter)	**10 CuYds/Sta for (5'x24') **25 m ³ /Sta for (130mmx7.3m)
"Mineral Aggregate" – Cubic Yard (cubic meter)	Do not use for estimate.
"Water" – MGallon (kiloliter)	1 Mg/Sta (12 kL/Sta)
"Fog Seal" – Gallon (liter)	0.15 Gall/yd ² (0.68 L/m ²)
** Quantity of Mineral Filler will vary depending on type of soil.	

Bituminous Surface Course – Section 512

"Bituminous Surface Course" – Square Yard (square meter)
 "Fog Seal" – Gallon (liter) 0.6 Gal/yd² (2.5 L/m²)

Calcium Chloride, Applied – Section 309

"Calcium Chloride Applied" – Ton (megagram) 3 lb/yd² (1.6 kg/m² or 0.0015 Mg/m²)

Cement Stabilized Bituminous – Special Provision

"Cement Stabilized Bituminous" – Station
 "Cement" – Ton (megagram) 5% weight of RAP
 "Water for Cement Stabilization" – Mgalion (kiloliter) 5% weight of RAP & Cement (convert to MGal)
 "Cold Milling, Class 2" – Station – Use if required in the "Pavement Determination"
 "Fog Seal" – Gallon (liter) - See Note 0.24 Gal/yd²
 Note: One application after the "CSB" Second application after the "Cold Milling, Class 2 if required.

Chip Seal – Section 515

"Chip Seal Aggregate" – Cubic Yard 25 lb/yd² (aggregate weight 1.4 tons = 1 yd³)
 (cubic meter) [11.0 kg/m² (aggregate weight 1.54 Mg = 1 m³)]
 "Chip Seal Emulsified Asphalt" – Gallon (liter) 0.36Gal/yd² (1.4 L/m²)

Cold In-Place Recycling (w/Foamed Asphalt) – Special Provision

"Cold In-Place Recycling with Foamed Asphalt" – Station
 "Performance Graded Binder (58-28)" - Ton 2% RAP (4"x24"= 1.15 ton/sta) (4"x28"= 1.34 ton/sta)
 "Fog Seal" – Gallon 0.10 Gal/yd²

Cold Milling – Section 510

"Cold Milling, Class _____" – Station, Square Yard (square meter)

Concrete Pavement Repair, Flexible Polymer Modified"

"Concrete Pavement Repair, Flexible Polymer Modified" – Square Yard
 Note: Special Provision describes depth of repair. Preparation of concrete, primer, bulking aggregate, and surfacing aggregate are subsidiary.

Concrete Sealer – Special Provision

"Penetrating Concrete Sealer" - Gallons 300 Square Feet per Gal

Concrete Surfacing Milling – Section 510

"Concrete Surface Milling" – Square Yard or Station

Cracking & Sealing Concrete Pavement – Special Provision

"Cracking & Sealing" – Square Yard (square meter)

Diamond Grinding and Texturing Pavement – Special Provision

"Diamond Grinding and Texturing Pavement" – Square Yard

Earth Shoulder Construction – Section 304

"Earth Shoulder Construction" – Station Shoulders are measured separately
 "Water" – MGallon (kiloliter) 0.25 MGal/Sta (3.0 kL/Sta)

Surfacing Under Guardrail – Special Provision

"Surfacing Under Guardrail" – Square Yards (square meters)

Note: Pay Item Includes asphalt or concrete surface (contractor's option) and subgrade preparation.

High Friction Surface Treatment – Special Provision

"High Friction Surface Treatment (1-Layer)" - SqYd

"High Friction Surface Treatment (2-Layer)" - SqYd

Hot In-Place Recycling – Special Provision

"Hot In-Place Recycling" – Station

"Emulsified Asphalt for Hot In-Place Recycling" - Gal 1.0% of RAP (2"x24"=69 gal/sta) (2"x28"=81 gal/sta)

Hydrated Lime Slurry Stabilization – Special Provision

"Hydrated Lime Slurry Stabilization" – Station

"Hydrated Lime" – Ton 1.50% weight of RAP (4"x24"= 0.9 tons/sta) (5"x24"= 1.1 tons/sta)

"Emulsified Asphalt For HLSS" – Gal. 1.75% weight of RAP & Lime (4"x24"= 245 gal/sta)(5"x24"= 307gal/sta)

"Fog Seal" – Gallon 0.10 Gal/yd²

Note: Growth factor approx. ¾" for a depth of 3" to 5". 1" for a depth of 6"

Intersections and Driveways – Section 302 & Section 503

"Preparation of Intersections and Driveways" – Square Yards (square meters)

"Placement of Asphaltic Concrete For Intersections and Driveways" – Square Yards (square meters)

Note: Asphaltic concrete paid for by roadway tonnage or megagrams.

Joint Sealing Asphalt to Concrete – Section 508

"Joint Sealing – Asphalt to Concrete" – Station (one side)

Mail Box Turnouts – Section 912 & Special Provision

"Preparation of Intersection and Drives" - Square Yard

"Placement of Drives and Intersections" - Square Yard

Microsurfacing – Section 514

"Microsurfacing Placement - Station

"Emulsified Asphalt for Microsurfacing" – Gallon (liter) 12.0% of total tons 240 Gal = 1 ton (1000L=1Mg)

"Aggregate for Microsurfacing" – Ton (megagram) 83.8% of total tons (Mg)

"Mineral Filler for Microsurfacing" – Ton 1.7% of total tons (Mg)

Note: Weight Factor is 0.0 Tn/100 ft² (2.1 Mg/m²)

Note: Lift thicknesses are ¾" and calculate rut depth if applicable.

Milling Concrete For Inlays – Section 510

"Milling Concrete For Inlays" – Each

Non-Woven Pavement Overlay Fabric – Special Provision

"Non-Woven Pavement Overlay Fabric" – Square Yard

Performance Graded Binder (-**) – Special Provision**

Use the table on page 6 to estimate the tons.

Perforated Pipe – Section 914

"_____ Perforated Pipe" – Linear Foot (LF)

"_____ Non-Perforated Pipe" - Linear Foot (LF)

Removal and Processing of Concrete Pavement – Section 312**Shoulder Subgrade Preparation – Section 302**

"Shoulder Subgrade Preparation" – Station

"Water" – MGallon (kiloliter) 0.5 MGal/Sta (6.0 kL/Sta)

*Note: Shoulders are measured separately***Special Surface Course – Special Provision***Note: Use this item if placing millings on driveways or under guardrail*

"Special Surface Course" – Square Yard (square meter)

"Fog Seal" – Gallon (liter) 2 applications, 0.20 Gal/yd² for soil and 0.30 Gal/yd² for the surface
(2 applications, 0.91 L/m² for soil and 1.36 L/m² for the surface)**Stress Absorbing Fiberglass Layer with Emulsified Asphalt (SAFLEA) – Special Provision**

Added item summer of 2017

"Stress Absorbing Fiberglass Layer with Emulsified Asphalt" – Square Yard (square meter)

"Armor Coat Emulsified Asphalt" – Gal (liter) 0.44 Gal/yd²"Armor Coat Aggregate" – Cubic Yard (cubic meter) 32 lb/yd² conversion factor 1.3 tons = 1 yd³**Subgrade Preparation – Section 302**

"Subgrade Preparation" – Station or Square Yard (square meter)

"Water" – MGallon (kiloliter) 1.0 MGal/Sta (12.0 kL/Sta) or 0.003 MGal/yd² (0.014 kL/m²)*Note: Subgrade Preparation calculated as total pavement footprint including bevel. Water calculated for pavement footprint plus 3' beyond. Plans show Subgrade Preparation 3' beyond pavement footprint.***Subgrade Preparation for Widening – Special Provision***Note: Use for concrete pavement widening*

"Subgrade Preparation for Widening" – Station (one side)

"Water" – MGallon (kiloliter) 0.5 MGal/Sta (6.0 kL/Sta)

Subgrade Stabilization – Section 303

"Subgrade Stabilization" – Station or Square Yard (square meter)

"Soil Binder" – Cubic Yard (cubic meter) 12.5 yd³/Sta for (6" x 30") [31 m³/Sta for (150mm x 9m)]"Water" – MGallon (liter) 1 MGal/Sta or 0.003 MGal/yd² (12.0 kL/Sta or 0.014 kL/m²)*Note: Subgrade Stabilization calculated as total pavement footprint including bevel. Soil Binder and Water calculated for pavement footprint plus 3' beyond. Plans show Subgrade Stabilization 3' beyond pavement footprint.***Surfacing – Special Provision**

"Surfacing _____" – Square Yard (square meter)

Note: Contractor's choice for pavement type, asphaltic concrete or portland cement concrete.

Surfacing Under Guardrail – Special Provision
 "Surfacing Under Guardrail" – Square Yard

Stabilized Subgrade (8"depth) – Special Provision

"Stabilized Subgrade Type Cement" – Square Yard	use if PI of soil is 20 or more
"Cement" – Ton	46 lbs/yd ² cement quantity is **7% of soil tons
"Stabilized Subgrade Type Fly Ash" – Square Yard	use if PI of soil is 19 or less
"Fly Ash" – Ton	66 lbs/yd ² fly ash quantity is **10% of soil tons
"Stabilized Subgrade Type Lime" – Square Yard	use if PI of soil is 20 or more
"Hydrated Lime" – Ton	33 lbs/yd ² hydrated lime quantity is **5% of soil tons
"Water" – MGallon	1 MGal/Sta or 0.003 Mgal/yd ²

Note: Stabilized Subgrade Type ___ calculated as total pavement footprint including bevel.
 Cement, Fly Ash, Hydrated Lime, and Water calculated for pavement footprint plus 3' beyond.
 Plans show Stabilized Subgrade Type "___" 3' beyond pavement footprint.

**Soil weight compacted in place, 110 lbs/ft³

Tack Coat – Section 504

"Tack Coat" – Gallon (liter)	
Factor for existing surface	0.150 Gall/yd ² (0.680 L/m ²)
Factor for between lifts	0.050 Gall/yd ² (0.230 L/m ²)

Temporary Surfacing – Special Provision

"Temporary Surfacing" _____ – Station or Square Yard (square meter)
 Note: Contractor's choice for pavement type, asphaltic concrete or portland cement concrete.
 Note: Subgrade Preparation, earth shoulder construction, water applied and removal are subsidiary.

Trenched Widening 1' – Special Provision

"Trenched Widening 1'" – Station Measured separately.

Note: Include "Earth Shoulder Construction" or
 "Earth Shoulder Restoration"

Trenched Widening 3' – Special Provision

"Trenched Widening 3'" – Station Measured separately.

Note: Include "Earth Shoulder Construction" or
 "Earth Shoulder Restoration"

Widening – Special Provision

"Widening" – Station Measured separately.

Ultra Thin Bonded Asphalt Wearing Course – Special Provision

"Ultra Thin Bonded Asphalt Wearing Course" – Ton
 "Performance Graded Binder" **--** - Ton
 "UTBAWC" will be SLX, SPR (Fine) or SPH (D.375) as noted in the "Pavement Determination"
 Note: Do not pay for Tack Coat

Performance Graded Binder (-**) Table**

Renaming PG Binder Types. Beginning with the January 2017 letting.

Asph. Conc. Type	PG Binder (**-**) Type	Gradation bands (0.5) multiply Asph. Conc. tonnage by	Gradation bands (0.375) multiply Asph. Conc. tonnage by	Gradation bands (0.19) multiply Asph. Conc. tonnage by
GGCRM	(58-28)	8.5%	NA	NA
GGCRMLV	(58-28)	8.5%	NA	NA
LC	(58V-34)	NA	NA	5.2%
SLX	(58V-34)	NA	4.2%	NA
SPR	(58H-34) (58V-34) If Current TADT>150	3.4%	NA	NA
SPR(Fine)	Same as SPR	NA	3.4%	NA
SPS	(58S-34)	3.2%	NA	NA
SPH	(58V-34)	3.8%	3.8%	NA
SRM	(58H-34)	2.8%	NA	NA

1" SLX thin lifts - add 15% to asphalt tons for slope and profile correction.

Hydrated Lime / Warm Mix Asphalt

Example: If you have 10534 tons of Asphaltic Concrete Type "SPR" there will be 10534 Each of "Hydrated Lime/WMA".

Asph. Conc. Type	"Hydrated Lime/WMA" Pay item is "Each" multiply tons of asphalt by
GGCRM	1
GGCRNLV	1
LC	1
SLX	1
SPR	1
SPR (Fine)	1
SPS	NA
SPH	1
SRM	1

Asphaltic Concrete Tonnage Table

Asphaltic Concrete Types

Inches	Bit	Bit							SPR(Fine)	
	Sand	Bit	OGFCORMM	GGCRM	GGCRMLV	LC	SLX	SPS	SPR	
	Base	Fnd						SPH	SRM	
	Crse	Crse								
	6.0	6.2	6.3	Tons per 100 Cubic Feet			7.25	7.30	7.35	7.40
				6.75	6.95	7.15				
				Pounds per Cubic Foot			145	146	147	148
	120	124	126	135	139	143				
				Tons/SqYd/Inch						
1	<u>0.045</u>	<u>0.050</u>	<u>0.050</u>	<u>0.051</u>	<u>0.052</u>	<u>0.054</u>	<u>0.054</u>	<u>0.055</u>	<u>0.055</u>	<u>0.055</u>
1.5										
2	<u>0.090</u>	<u>0.093</u>	<u>0.095</u>	<u>0.101</u>	<u>0.104</u>	<u>0.107</u>	<u>0.109</u>	<u>0.110</u>	<u>0.110</u>	<u>0.111</u>
2.5										
3	<u>0.135</u>	<u>0.140</u>	<u>0.141</u>	<u>0.151</u>	<u>0.156</u>	<u>0.161</u>	<u>0.163</u>	<u>0.164</u>	<u>0.165</u>	<u>0.166</u>
3.5										
4	<u>0.180</u>	<u>0.186</u>	<u>0.189</u>	<u>0.202</u>	<u>0.208</u>	<u>0.214</u>	<u>0.218</u>	<u>0.219</u>	<u>0.221</u>	<u>0.222</u>
4.5										
5	<u>0.225</u>	<u>0.233</u>	<u>0.236</u>	<u>0.253</u>	<u>0.260</u>	<u>0.268</u>	<u>0.272</u>	<u>0.274</u>	<u>0.276</u>	<u>0.278</u>
5.5										
6	<u>0.270</u>	<u>0.279</u>	<u>0.284</u>	<u>0.303</u>	<u>0.313</u>	<u>0.322</u>	<u>0.326</u>	<u>0.329</u>	<u>0.331</u>	<u>0.333</u>
6.5										
7	<u>0.315</u>	<u>0.326</u>	<u>0.331</u>	<u>0.354</u>	<u>0.365</u>	<u>0.375</u>	<u>0.381</u>	<u>0.383</u>	<u>0.386</u>	<u>0.388</u>
8	<u>0.360</u>	<u>0.372</u>	<u>0.378</u>	<u>0.405</u>	<u>0.417</u>	<u>0.429</u>	<u>0.435</u>	<u>0.438</u>	<u>0.441</u>	<u>0.444</u>
9	<u>0.405</u>	<u>0.419</u>	<u>0.425</u>	<u>0.456</u>	<u>0.469</u>	<u>0.483</u>	<u>0.489</u>	<u>0.493</u>	<u>0.496</u>	<u>0.500</u>
10	<u>0.450</u>	<u>0.465</u>	<u>0.473</u>	<u>0.506</u>	<u>0.521</u>	<u>0.536</u>	<u>0.544</u>	<u>0.548</u>	<u>0.551</u>	<u>0.555</u>

Asphaltic Concrete Megagram Table

Asphaltic Concrete Types

Bit Sand Base Orse	Bit Fnd Orse	LC	SRM SLX	SPH SPS	SPR(Fine) SPR HRB
-----------------------------	--------------------	----	------------	------------	-------------------------

Megagrams per Cubic Meter

1.922	1.986	2.291	2.323	2.339	2.355	2.371
-------	-------	-------	-------	-------	-------	-------

Megagram per Square Meter - Millimeter

mm	<u>0.0250</u>	<u>0.0258</u>	<u>0.0298</u>	<u>0.0302</u>	<u>0.0304</u>	<u>0.0306</u>	<u>0.0308</u>
13	<u>0.0481</u>	<u>0.0497</u>	<u>0.0573</u>	<u>0.0581</u>	<u>0.0585</u>	<u>0.0589</u>	<u>0.0593</u>
25	<u>0.0577</u>	<u>0.0596</u>	<u>0.0687</u>	<u>0.0697</u>	<u>0.0702</u>	<u>0.0707</u>	<u>0.0712</u>
30	<u>0.0770</u>	<u>0.0795</u>	<u>0.0916</u>	<u>0.0929</u>	<u>0.0936</u>	<u>0.0942</u>	<u>0.0948</u>
40	<u>0.0865</u>	<u>0.0904</u>	<u>0.1031</u>	<u>0.1045</u>	<u>0.1053</u>	<u>0.1060</u>	<u>0.1067</u>
45	<u>0.0962</u>	<u>0.0994</u>	<u>0.1146</u>	<u>0.1162</u>	<u>0.1170</u>	<u>0.1178</u>	<u>0.1186</u>
50	<u>0.1154</u>	<u>0.1193</u>	<u>0.1375</u>	<u>0.1394</u>	<u>0.1404</u>	<u>0.1414</u>	<u>0.1424</u>
60	<u>0.1539</u>	<u>0.1590</u>	<u>0.1833</u>	<u>0.1858</u>	<u>0.1872</u>	<u>0.1885</u>	<u>0.1898</u>
80	<u>0.1732</u>	<u>0.1789</u>	<u>0.2062</u>	<u>0.2091</u>	<u>0.2106</u>	<u>0.2120</u>	<u>0.2134</u>
90	<u>0.1924</u>	<u>0.1988</u>	<u>0.2291</u>	<u>0.2323</u>	<u>0.2340</u>	<u>0.2356</u>	<u>0.2370</u>
100	<u>0.2018</u>	<u>0.2085</u>	<u>0.2406</u>	<u>0.2439</u>	<u>0.2456</u>	<u>0.2473</u>	<u>0.2490</u>
105	<u>0.2309</u>	<u>0.2386</u>	<u>0.2749</u>	<u>0.2788</u>	<u>0.2808</u>	<u>0.2827</u>	<u>0.2846</u>
120	<u>0.2501</u>	<u>0.2584</u>	<u>0.2978</u>	<u>0.3020</u>	<u>0.3042</u>	<u>0.3063</u>	<u>0.3084</u>
130	<u>0.2595</u>	<u>0.2681</u>	<u>0.3093</u>	<u>0.3136</u>	<u>0.3158</u>	<u>0.3179</u>	<u>0.3218</u>
135	<u>0.2886</u>	<u>0.2982</u>	<u>0.3437</u>	<u>0.3485</u>	<u>0.3510</u>	<u>0.3534</u>	<u>0.3558</u>
150	<u>0.3463</u>	<u>0.3578</u>	<u>0.4124</u>	<u>0.4181</u>	<u>0.4212</u>	<u>0.4241</u>	<u>0.4270</u>
180	<u>0.3940</u>	<u>0.4071</u>	<u>0.4697</u>	<u>0.4762</u>	<u>0.4795</u>	<u>0.4878</u>	<u>0.4961</u>
205	<u>0.4425</u>	<u>0.4572</u>	<u>0.5269</u>	<u>0.5343</u>	<u>0.5382</u>	<u>0.5419</u>	<u>0.5456</u>
230	<u>0.4901</u>	<u>0.5064</u>	<u>0.5842</u>	<u>0.5924</u>	<u>0.5964</u>	<u>0.6005</u>	<u>0.6046</u>
255	<u>0.5387</u>	<u>0.5566</u>	<u>0.6415</u>	<u>0.6504</u>	<u>0.6552</u>	<u>0.6597</u>	<u>0.6642</u>
280	<u>0.5862</u>	<u>0.6057</u>	<u>0.6988</u>	<u>0.7085</u>	<u>0.7134</u>	<u>0.7183</u>	<u>0.7232</u>
305	<u>0.6343</u>	<u>0.6554</u>	<u>0.7560</u>	<u>0.7666</u>	<u>0.7719</u>	<u>0.7772</u>	<u>0.7825</u>
330	<u>0.6823</u>	<u>0.7050</u>	<u>0.8133</u>	<u>0.8247</u>	<u>0.8303</u>	<u>0.8360</u>	<u>0.8417</u>
355							

Chapter 10: Laboratory Procedures - Testing and Sample Preparation

Date: 1/5/07

Source: Syslo

TESTING AND SAMPLE PREPARATION FOR:

- 1) Lime Modified Subgrades
- 2) CKD Modified Subgrades
- 3) Fly Ash Modified Subgrades
- 4) Full Depth Reclamation with Fly Ash
- 5) Full Depth Pavement Pulverization using subbase material

LIME MODIFIED SUBGRADES (using pebble quicklime)

- 1) Perform Eades and Grim test on soil to find target lime content (12.40 pH)
- 2) Perform soluble sulfates test on soil (<0.2% soluble sulfates in 10:1 H₂O to Soil)
- 3) Prepare specimens at 4% over optimum moisture (virgin soil)
- 4) Prepare specimens at target lime content and 1% over and 1% under
- 5) Compact specimens
- 6) Cure in sealed container at 75 degrees near 100% humidity for 6 days
- 7) Cure in exposed atmosphere at 75 degrees for 24 hours
- 8) Perform unconfined compression tests
- 9) Report : virgin soil PI
 virgin soil compressive strength
 virgin soil optimum moisture & density
 modified soil PI
 modified soil compressive strength
 modified soil density

CKD MODIFIED SUBGRADES (minimum 20% free lime material)

- 1) Perform soluble sulfates test on soil (<0.2% soluble sulfates in 10:1 H₂O to Soil)
- 2) Prepare specimens at 2% over optimum moisture (virgin soil)
- 3) Prepare specimens at 4, 6 & 8% CKD
- 4) Compact specimens
- 5) Cure in sealed container at 75 degrees near 100% humidity for 6 days
- 6) Cure in exposed atmosphere at 75 degrees for 24 hours
- 7) Perform unconfined compression tests
- 8) Report : virgin soil PI
 virgin soil compressive strength
 virgin soil optimum moisture & density
 modified soil PI
 modified soil compressive strength

FLY ASH MODIFIED SUBGRADES (using class C fly ash)

- 1) Prepare specimens at 2% over optimum moisture (virgin soil)
- 2) Prepare specimens at 10, 12 & 15% Fly ash
- 3) Compact specimens
- 4) Cure in sealed container at 75 degrees near 100% humidity for 6 days
- 5) Cure in exposed atmosphere at 75 degrees for 24 hours
- 6) Perform unconfined compression tests
- 7) Report : virgin soil PI
 virgin soil compressive strength
 virgin soil optimum moisture & density
 modified soil PI
 modified soil compressive strength
 modified soil density

FULL DEPTH RECLAMATION (using class C fly ash)

- 1) Prepare samples by adding water to make the sample friable (millings and soil)
- 2) Prepare specimens at 8%, 10% & 12% Fly ash
- 3) Add water 4% by weight of RAP + Ash
- 4) Add soil based on thickness of soil incorporated in reclamation process
- 5) Dry back small sample of blended material to determine total moisture content
- 6) Compact specimens
- 7) Cure in sealed container at 75 degrees near 100% humidity for 6 days
- 8) Cure in exposed atmosphere at 75 degrees for 24 hours
- 9) Perform unconfined compression tests
- 10) Report : compressive strength, moisture & density

Pavement Designers give this spreadsheet to the lab with updated pavement thickness and project information.

Source: Shared Folder - ...Pavement Design\Stabilization Design\FDR w PC Lab Comps\

Project Name: [Redacted]
 Project No.: [Redacted]
 Control No.: [Redacted]
 Date: [Redacted]

FULL DEPTH RECLAMATION w/CEMENT

Enter thickness

Unit Weights				
144 lbs/CuFT		Recycled Asphalt Pavement (RAP)	8.50	Average core depth w/out soil
120 lbs/CuFT		Rock	0.00	
110 lbs/CuFT		Soil	1.00	
		Total reclaimed depth	9.50	Total depth on PD and Plans
62.4 lbs/CuFT		Water (4% of wt. of RAP + PC)		
195 lbs/CuFT		CEMENT (various % of wt. of RAP)		

Weight of RAP, Rock and Soil= 2,500grams

CEMENT Blend (grams)				
	3% CEMENT	5% CEMENT	7% CEMENT	9% CEMENT
RAP	2294	2294	2294	
Rock	0	0	0	
Soil	206	206	206	
CEMENT	69	115	161	
Water	95	96	98	

Chapter 11: History of NDOT Asphalt

Date: 9/12/07 (edited 11-2018)

Source: Koves

ASPHALT THROUGH THE YEARS IN NEBRASKA (1950-2006)

FIFTIES TO EARLY SIXTIES

During the fifties and early sixties, a Low Type asphaltic concrete was produced. It consisted of gravel, sand and limestone dust filler. The mix design was made by the Bituminous Engineer and in the lab after mixing, a 4" x 4" asphalt cylinder was made on a compression machine. It consisted of a 4" mold with a double plunger. With the bottom plunger in place and the molding cylinder supported temporarily on the two steel bars, the hot mixture was added to the mold. The mixture was spaded two or three times around the inside of the mold with a heated spatula to reduce surface "honeycomb." It was then compressed between the top and the bottom plungers under an initial load of about 150 psi to set the mixture against the sides of the mold. The pressure was then released and the support bars removed to permit full double plunger action and the entire load of 3000 psi was applied and maintained for two minutes. After removal from the mold specimens were cooled and a density was run by weighing in air and then weighing in water. The special provisions provided that the mixture be compacted to a percentage of the control density. During production a 2" mold was used to control density and had to be a certain percentage of the original 4 x 4 puck. These densities were made every 500 tons and everything was molded at 255°F ±5.

EARLY SIXTIES TO MID SEVENTIES

As more earth roads were converted to gravel, more counties are showed interest in bituminous surfacing. The early 60's saw the culmination of many efforts, and high type bituminous road construction reached nearly fifty miles, more than half the total of gravel roads constructed with Federal funds in the same period.

July 1, 1964 to June 30, 1965, 144.8 miles of asphaltic concrete was contracted for work. The specifications and testing of asphaltic concrete was getting under way and by June 30, 1966 another 156.7 miles was let.

Testing of asphalt materials had come a long way. The first mix designs of the sixties and early seventies were created by the Flexible Pavement Assistant Engineer (FPAE). The mixes were based on the amount of traffic.

For higher traffic, a Type "A" mix was used. It contained crushed limestone, crushed gravel and limestone dust for filler with about 15% retained on the 3/8" sieve. For lower traffic roads the mix was Type "B" and contained mostly river gravels, sand and limestone dust filler and retained about 22% on the #4 sieve. And finally a mix used for leveling courses and bridge wedges called Type "C". It contained about 100% crushed road gravel, had about 8% retained on the #4 sieve and an asphalt content of around 6.0 to 7.0%. It worked very well for leveling courses and also from keeping moisture from getting to the surface from below. The contractor would submit the materials for use and the aggregate was tested for quality and gradation. The FPAE would design the mix. He would measure the gradations of the aggregate. After figuring out the percentages it was sent to the lab for mixing and testing. At least 2 to 3 designs were always made, one with high asphalt content and one about a percent lower. On each design a variety of testing was done. The testing done on these 2 to 3 designs would verify that a mix would meet specification. The AC contents, gradations and densities controlled the project.

The asphalt cement used was penetration graded (hardness) and normally was 85 -100. All designs were mixed at 300°F and all Marshall specimens were compacted at 250°F ±5. Three 4" X 2 1/2" specimens were molded using a Marshall hammer. This test was a 10 lb. slide hammer attached to a 4" round, slightly angled, foot. The heated material was placed into the mold and then the whole assembly was placed on a rotating base. The 10 lb. slide hammer was inserted into the mold and the hammer would pound the asphalt a certain number of times,

usually 50 blows. The sample was then flipped over and the routine repeated. After slight cooling, the samples were extruded and set aside to cool. When samples were at room temperature (approx. 1 hour), samples were weighed in air, weighed in water and saturated surface dried with a damp towel and weighed again. The densities were then figured and an average was obtained. All three samples were then placed in a 140° F water bath for 30 minutes ± 5 and stability and flow was obtained.

Also from the design a Voidless Density (zero percent air voids) was obtained. It consisted of a sample approximately 800 – 1000 grams which was cooled and broken into individual pieces. When cooled it was placed into a calibrated glass container and weighed, covered with water at least an inch over the surface of the mix and placed under vacuum of about 28 mm Hg. After about 10 minutes the pressure was released and the sample was carefully placed into a water bath and weighed again. A maximum specific gravity was then figured.

Next an extraction sample of about 1000 gr. was weighed and placed into an aluminum bowl. Perchloroethylene (a very strong degreaser) was then added and the sample was stirred until broken down. From there the sample was lidded and placed into the Rotorex (a centrifuge) where the liquid and asphalt was spun off into a calibrated flask. Perchloroethylene was then added in small portions and spun until liquid became straw colored. The clean sample was then scraped from the bowl and placed into an oven to dry. The liquid in the flask was also weighed and the temperature was taken. After the aggregate was dried and weighed, an asphalt content could be calculated. The oven dried sample was then washed, dried again and the gradation was obtained to ensure the specification of design.

The last test run was a Dry Displacement on the combined virgin aggregate. With the results from this and a similar test called a Volumetric test, was how the production was controlled in the field. A 1000 ml flask was used and a 1000 gram sample of the combined virgin aggregate was added. Perchloroethylene was added to a pre-determined line on the flask and the flask was then corked, rolled and bounced on a rubber pad for 10 minutes to remove all the air. After ten minutes, the flask was filled back to the line and a siphon was used to remove solvent to a calibrated limit, weighed and a temperature was taken. The volume displaced by the virgin aggregate was then figured. During production in the field they used the same test, only with the asphalt coated roadway material. A random sample was taken and a 1000 gram sample was split out from that. The testing was done the exact same way, called a Volumetric and when completed the two numbers were algebraically compared and an asphalt content was determined. The aggregate was then washed with solvent and a gradation was run.

After all the tests were run and the results were all figured, the engineers from the Flexible Pavement and the lab supervisor would all gather and look at the results to decide the asphalt content for production. They looked at the stability and flow of the Marshalls, how the mix looked, air voids, voids filled with asphalt (VFA) and then each voted on a percent binder to be added and the results were averaged. The required asphalt content, aggregate proportions and combined gradation to be maintained was then sent to the contractor and construction could begin.

During production the contractor furnished a lab for a state employee to be on the job. The state employee ran all Volumetric test and gradations out of that lab. Production sample were also sent to the Branch lab closest to the job sight for testing but the only pay factor items were for asphalt content, gradation and density.

Always trying new things and experimenting with different materials in asphalt was also big during this time period. We had already experimented using crushed glass as a replacement for aggregate and in the late sixties, the first of a few asbestos roads were built, using approx 2% asbestos to replace the mineral filler. In the early 70's we tried to use crushed Bakelite and there are even a couple of roads that contain shredded asphalt shingles. It seemed like everyone thought that waste products could be used in asphalt.

The asphalt cement (AC) during this era was penetration (hardness) and viscosity graded and the penetration most used was an 85 -100. Voids in the asphaltic concrete surface (field density) varied from 3.5% to 12.0% depending on how much AC it contained and there were no real minimum or maximum requirement. Laboratory voids on Marshall specimens were running about 1.2% to 4.5%.

One other thing that should be noted during this time period is the crushing of our river gravels. During the sixties and seventies and even some into the eighties the specification for the crushing of gravels was gradation limits before and after crushing. Most notably, the crushing specification for gravels was $70 \pm 30\%$ retained on the #4 sieve before crushing and after crushing the specification was 8 ± 8 retained on the #4 sieve. This made a highly angular material and worked quite well in our Type "A" mix designs for durability on our higher traveled roadways with the tire pressures and truck traffic at the time.

MID SEVENTIES THROUGH THE EIGHTIES

Prior to 1977, limestone dust had been used exclusively as mineral filler for asphaltic concrete. In 1977 that changed, as soils and fly ash, were tried and then used as mineral filler, both of which were cheaper to use. Soil was readily available everywhere and fly ash was a waste product of cement plants. Also tried but with not much success, were stack dust, beet lime and volcanic ash. Soil seemed to work quite well as filler, if clay deposits were avoided. Light Peorian soil worked best and was easily broken down into a fine dust. If the clay content was too high it would ball up and leave pock marks in the surface after a rain.

In about 1977, the department started to read about the highways in Europe and how well they were performing. The Europeans were using an open-graded mix on their high speed roadways. Nebraska's first attempt at this, was placed on East "O" Street from 84th Street to the Lancaster county line in 1978. It contained Platte River gravel graded mostly to be retained on the 3/8" and #4 sieve and fly ash for filler. It was called "M-1", laid 1" thick and contained an AC of 4.70%. It was laid on top of a 2" mix called "Stone-filled" which contained about 60% large limestone (mostly + 1/2") some crushed gravel and fly ash filler with a AC of 3.0%. This design worked quite well for several years and being so open was also very drainable. The only problem was that with the rounded river gravels did not have much skid resistance. In 1979, this mix was redesigned on the Alvo spur to N-50 project. To increase skid resistance, crushed limestone, crushed gravel and fly ash were added, all the round river gravel removed and the mix was mostly retained on the #4 sieve.

Another new technique in the early 80's was milling of the roadway and using the millings back into the mix as aggregate. The first full fledged design of this nature was F-281-1(101) Cowles Spur North and 50% of the design was the milled material. The rest was made up of Platte River gravel. This design was a little different because the aged binder, already in the millings, had to be accounted for. The millings had to be extracted using Trichloroethylene instead of Perchloroethylene, and the amount of asphalt figured into the total. During the early designs the lab would run a penetration on the aged asphalt. This was done by taking the liquid from our extracted material and boiling the solvent off till just the raw asphalt was left. The raw asphalt was poured into a small tin and cooled. After cooling the sample was placed in a 77° F water bath for one hour and then a penetration was run. This told us how hard the old asphalt was and what grade of asphalt cement to use. In the eighties, we went to viscosity graded asphalt and AC-10 was comparable to an 85 -100 which is what was used for most virgin mixes. Since the asphalt was a lot harder in the millings, it was thought that using a softer grade would blend with the aged asphalt and create the desired grade. An AC-5 was used, which when pen graded, would be like a 120 -150. For this design, 2.50% of new asphalt was added for a total of 5.10%. By introducing the millings into the design it was a great cost savings to the State because of owning the millings. The project special provisions allowed the contractor to select the method for removal and pulverization of the old bituminous material. The only two requirements were that all of the removed material had to be reduced in size to pass a 2" sieve and that including any of the underlying base course should be avoided. No major problems were encountered during the production and lay down of the recycled mixture. Actually the material appeared to be somewhat more stable than a design, using virgin materials of the same gradation.

In the 70's and early 80, the mix designs were still made by the department, field testing was still done by the state and the asphalt cement was still tested for penetration and viscosity but the department was moving forward. We were always looking at new technologies, test methods and designs around the country. As trucks got heavier, tire pressure increased and traffic got higher, the designs had to get more structurally sound also.

LATE EIGHTIES TO MID-NINETIES

During the eighties the Interstate was being overlaid and needed high performing designs that would withstand the increase in traffic. A modification of the Alvo to N-50 mix was tried. Limestone was replaced with quartzite, a ledge rock from South Dakota. The quartzite material was pink and very hard and angular and the "MQ" was born. "MQ" was open-graded, with a thick coating of asphalt, very drainable and laid in a thickness of 1". This meant that during a rainstorm, the water would drain off the pavement and not be thrown onto the windshield of the vehicle behind. The "MQ" contained about 65% quartzite, 25% crushed gravel and about 5 - 10% fly ash. Eventually the "MQ" covered the Interstate and performed very well for many years.

Also during the eighties, more recycling work was done, this time with crushed concrete. Stockpiles of milled crushed concrete showed up around the state. Recycled asphalt pavement (RAP) jobs were working well, why not try this also. The problems encountered were minimal but there were things to be worked through. Crushed concrete was very absorptive and no matter how much asphalt was added the mix always looked dry. One other problem encountered throughout the years was that the piles of crushed concrete would set up and harden again over the winter and in the spring would have to be broken into again and recrushed. Recycled crushed concrete was tried for a few years, but never really took off for asphalt use.

In 1988 the FHWA issued a Technical Advisory (TA) about the asphalt design and field control of the mixes. The TA's purpose was to set forth guidance and recommendations relating to asphalt concrete pavement, covering the areas of material selection, mix design and mixture production and placement. The TA was directed primarily toward developing quality asphalt concrete pavements for high-type facilities. It covered such things as different materials, quality of the aggregates, how crucial dust to asphalt was, film thickness, properties of the binder, stripping, proper mix design and the control limits, etc.

In 1993, 94 and 95 a consultant was hired by the department to conduct training on mix designing, properties of the mixes, what to look for and how to get the desired volumetric properties with Nebraska aggregates. Voids, voids in the mineral aggregate (VMA), minimum AC and many other things were learned that needed to be done to conform to what the FHWA's technical advisory deemed necessary for better roadways. New designs were initiated, crushing values of materials were looked at, target field voids were put at 3.5 - 4.0% and different Marshall blows for higher traffic roads. Even any millings that were used in the designs were given crushed values. Our new designs were as follows:

Type 1 80% crushed value for combined mineral aggregate
 75 blow Marshall design
 A maximum of 60% limestone in the mix
 4.0% target field air voids

Type 2 60% crushed value for combined mineral aggregate
 75 blow Marshall design
 A maximum of 60% limestone in the mix
 4.0% target field air voids

- Type 3 80% crushed value for the mineral aggregates
75 blow Marshall design
A minimum of 50 % quartzite, granite or crushed gravel meeting 100% crushed value criteria.
4.0% target field air voids
- Type 4 60% crushed value for the combined mineral aggregate
50 blow Marshall design
A maximum of 60% limestone in the mix
4.0% target field air voids
- Type 5 80% crushed value for the combined mineral aggregate
50 blow Marshall design
A minimum of 50% quartzite, granite or crushed gravel meeting the 100% crushed value criteria.
4.0% target field air voids
- Type 7C Roadway mix constructed under traffic and parking areas
20% crushed value for the combined mineral aggregate
50 blow Marshall design
A maximum of 60% limestone in the mix
3.5% target field air voids
- Type 7 Roadway mix when closed to traffic or shoulder mix
0% crushed value for the combined mineral aggregate
50 blow Marshall design
A maximum of 60% limestone in the mix
3.5% target field air voids

Voids are the spaces between asphalt coated aggregate after molding of the Marshall specimens or after the rollers in the field. Voids are necessary for the longevity of the roadway. Too high of voids will tend to compact and ravel and if the voids are too low there is no place for the asphaltic concrete to go but to push and shove. After lay down and the finish rollers, the goal was 6 – 8 % voids. After 6-10 years of traffic, the air voids should stabilize at 3 – 5% and remain for a few more years. When the roadway gets to 2% voids or less the pavement is said to be at the end of its life.

Voids in the Mineral Aggregate (VMA) are the air voids between the virgin aggregate if you could mold a specimen of just the aggregate. VMA is important for design so that there is room for the asphalt cement. VMA varies from 13 – 15% and is dependent on the nominal aggregate size.

By 1994 the mix design and field testing was the contractor responsibility with the department verifying all results, thus the Quality Assurance/ Quality Control (QA/QC) program was initiated. The Department of Roads had 4 Branch laboratories (N. Platte, Grand Island, Norfolk and Omaha) with the main lab in Lincoln. All five labs were furnished the same equipment so that correlation of testing between state labs was not a problem. Also a list of equipment was made for the contractor that was needed for their testing. The contractors began buying trailers and equipping them with the necessities. Marshall machines, rice apparatus (voidless density), ovens, sieves, shakers, sample splitters, running water, air conditioning, computers, fax machines, etc. were all included in what the contractors needed to include in their labs. Unfortunately our consultant made the mistake of saying that the sands of Nebraska were “unique”. These sands, unlike the rest of the country, were great builders of VMA and the cost for the material was minimal. Our new mix designs, though having better mix and field specifications, ended up not being exactly the product that we wanted. Although we had a specification for

crushed value on the design, it seemed like after a couple of years that more and more of our “unique” sand was showing up in our mixes. We had given contractor crushed values for their aggregates which we thought were reasonable. For example, crushed ledge rock, was given a value of 100%. Crushed gravel was given 80% crushed value and plain river gravels and sands were 0%. If a design contained 25% crushed rock and 65% crushed gravel and 10% gravel its crushed value was 77% $((25 \times 100\%) + (65 \times 80\%) + (10 \times 0\%) = 77\%)$. If the design criteria for this mix had 60 % crushed value, it looked like a good design. Somehow though, more and more of our VMA building sands were entering the designs and our mixes ended up becoming very tender. The department ended up with designs that would rut or fail even before the job was finished. We had taken a big step with our specifications during this time even if the roads ended up not quite where we wanted them. The contractor was running their own samples with our verification. Field samples were now being controlled, not only density and binder content, but voids, VMA, minimum asphalt contents, gradations and dust to asphalt content. Even though some mix designs left a lot to be desired, some worked quite well and we had learned quite a bit that helped us get into the next phase of building better roadways.

In the late 80's the Strategic Highway Research Program (SHRP) developed the “Superpave” program. The program consisted of new ways to test asphalt cement (now called Performance Graded Binders) and to check the asphaltic concretes properties during design and field testing. Most testing at SHRP was finished by the early 90's and the Federal Government was looking for states to try the new test methods. In 1996 and 97 the Feds offered states money to buy new Superpave equipment and build roads to the new specifications. Superpave design methods are based on Equivalent Single Axle Loads (ESAL). This is a means of equating various axle loads and configurations to the damage done by a number of 18,000 pound single axles with dual tires, on pavement of specified strength, over the design life of the pavement. Originally 7 designs were created with SP-1 being the road with the lowest ESAL and SP-7 the highest.

Testing and equipment was quite different also, especially on the binder side. New equipment was purchased and new test methods were learned. The asphalt cements went from 85 -100 and AC-10 to PG 58 -28 which were climate and temperature graded binders. The numbers were based on records from the National Weather Service and several different weather stations around the United States from the last ten years. The first number (58°C) being the average high temperature of the roadway during the summer months and the last (-28°C) being the one time low during the winter. Higher grades of binder were also better suited for highways with more ESAL's such as PG 70 -28 (polymer modified) may be used on the Interstate system because of the higher tire pressures and larger trucks.

Binder testing changed with testing at high temperature, low temperature, before aging and after aging, checking phase angles and elastic properties. The Dynamic Shear Rheometer (DSR) was used to report phase angles and the dynamic shear of the binders. Phase angles indicated whether polymer modifications were present. Dynamic shear was an indication of the binder stiffness at the upper grade temperature and also indicates the “viscous behavior” at a lower temperature, after aging.

The Rolling Thin Film Oven (RTFO) simulated the aging of an original binder after going through the field hot mix plant during production. This material could be re-run through the DSR to measure aging occurs during production.

The Pressure Aging Vessel (PAV) took the RTFO material through a timed process of controlled heat and oxidation. The PAV simulated the long term aging of the binder before it was run through the DSR for the purpose of Dynamic Shear (lower temperature viscous behavior) testing again. The Bending Beam Rheometer (BBR) and Direct Tension (DT) gave test data at the lower temperatures. The BBR and DT were used to determine the low temperature stiffness and tensile properties of the binder. Stiffness correlates with brittleness at low temperatures and brittle materials are more likely to crack (BBR) or fracture (DT).

The Elastic Recovery Apparatus worked in conjunction with the DSR phase angle for modified binders. It indicated whether adequate polymer modification was present by measuring its “elastic” properties.

The changes on the mix design were not quite so drastic. In place of the Marshall which molded a 2 ½”x 4” specimen, was a Gyratory Compactor which molded a 4 ½” X 6” specimen. Instead of the slide hammer pounding the sample a certain number of times on each side, a plunger would be hydraulically inserted into the mold with 600Kps of pressure, an angle of 1.25° placed on the sample and a set number of gyrations would all be started and stopped automatically. Each time the mold rotated, a height was obtained and printed out. All the new designs were figured for N initial, N design and N maximum and density were figured at each height. From this puck a density was run and that density was N maximum or end of the life of the pavement. N design and N initial were back figured with a simple algebraic formula.

The Rice test (maximum gravity) was basically run the same way as always and with this number and the gyratory densities, air voids at each level were figured. N design should be between 3 & 5% air voids and N maximum should be somewhere around 2%.

Superpave design changed the way that the asphalt content was obtained. The use of toxic chemicals and centrifuges were eliminated. The new method involved an ignition oven where temperature was kept at 538°C and when the asphaltic concrete sample was weighed and placed into the ignition oven, the weight was entered on the oven. As the asphalt was burned off, the asphalt content was printed out and automatically shut off when burn off was complete. After cooling, this burned off sample could then be washed and a gradation obtained. Perhaps the greatest innovations that SHRP developed, was the technique for finding the angularity of the fine materials. The method obtained a void content and the device was very simple but effective, involving -8 /+100 material. A mason jar with no bottom was inverted and screwed to a calibrated funnel on a tripod. Below the funnel was a calibrated brass cylinder. A finger was then placed over the hole in the funnel and the sample was poured into the mason jar and leveled. The finger was removed and the sample free fell into the cylinder. The cylinder was carefully scraped off with a straightedge and weighed. After calculating, a person could tell how angular the fines were by the void content. The higher the number the more angular the fine material was. This test was very important to roadway longevity.

Other aggregate tests included the Coarse Aggregate Angularity which was a visual count of materials above the #4 sieve. Flat and Elongated which used a device at 5:1 ratio to determine the amount of flat pieces compared to normal crushed material. Too many flat pieces in a roadway surface can cause early failure. The last test, Sand Equivalent showed the relative proportions of fine dust or claylike material in graded aggregate.

LATE NINETIES TO MID 2000’S

The first 2 Superpave jobs were let in 1997. The contractors were just getting gyratory compactors, the design was ran with both gyratory compactor and Marshall hammers as a comparison. Both designs were called SP-97. The first project, let in February, was constructed by U.S. Asphalt from Omaha was RD-50-1(1006), In Tecumseh. It was an SP-4(3/4”) containing 28%-5/8” crushed rock, 32%- ¼” limestone chips, 15% limestone manufactured sand and 25%- crushed gravel. The binder used was PG 64 -22 and the percent added was 4.65% (by weight of mix). Superpave mix specifications used were: Gyratory % air voids @ Ndes = 4.0 ±1.0%, VMA = 13%, Void filled with Asphalt = 65 – 78 % and field Marshall air voids = 3.5 ±1.0% was subject to change based on the Gyratory results. The job was only ½ mile long and was produced during early to mid June. During the Test Strip, the voids barely reach 2.0% and VMA never got over 11.5%. Binder and aggregates were adjusted slightly to get the design into specification and production continued. The new result was fairly consistent but still had some highs and lows. The mix was quite open and in some spots was placed between curb and gutter.

The second project, let in May, was constructed by Henningsen Construction from Atlantic, IA was EACSTPD-STPP-50-2(120) Louisville to Springfield. It was an SP-5(1/2") containing 5%- 5/8" limestone chips, 25%- 1/4" limestone chips, 30%- crushed gravel, 20% limestone manufactured sand, 20%- 3/4" crushed gravel. The binder used was PG 64 -22 and the percent added to the design was 4.90%. Superpave mix specifications that were used were: VMA = 14%, Voids Filled with Asphalt = 65% to 75%, Gyratory air voids @ Ndes = 4.0±1.0 and initial field Marshall air voids of 4.0±1.0% subject to change based on gyratory results. The seven miles of construction took place the end of August and finished in early September. The production Gyratory pucks at Ndes ran very close to the specifications with the voids at about 4.0% and VMA running about 14.3%. Marshall results ran slightly lower on both. This project was built along a rock quarry with very large, heavy truck traffic and seemed to perform quite well.

In 1998, seven projects were Superpave. The department went from one end of the ESAL spectrum to the other. We made two SP-1's, two SP-2's, one SP-3, one SP-4 and one SP-5 on Interstate 680 in Omaha. All of the designs contained between 17 and 25% millings with the exception of the 680 project, where no millings was used at all. The department bought Gyrotories for all the branch labs and the contractors were gearing up with all the necessary Superpave equipment too. It was quite a costly project, but there was a significant increase in the performance of the asphaltic concrete over time.

By 1999, thirty-six Superpave projects were let and the Marshall equipment was being used less and less. The contractors were designing mixes using the gyratory compactor and using Superpave volumetric and consensus properties to control the mix in the field. Three 10,000 gram batches of their design were submitted to the NDOR lab for verification along with 6 gyratory pucks prepared for moisture susceptibility. The department was verifying all mix designs and correlating well with the contractor design and field samples.

In the 1960, 70 and 80's designs were controlled with field density, asphalt content and gradation. In the 1990's, design controls were added for Voids, VMA, minimum asphalt content and a certain percent of crushed materials. Superpave added even more control. By 1999, the department was looking at plant produced gradations, binder content, air voids, VMA, VFA, FAA, CAA, dust to asphalt and even whether the design had a tendency to strip or not. Better grades of binder were used for higher traffic roadways. At least one QC sample was tested for each 750 ton of mix produced. That random sample was split by the contractor and half was sent to the NDOR lab for correlation. During construction, if two consecutive points were outside the Specification limits, production was stopped until the problem was fixed.

By the end of 1999, it was decided that certification of the contractors test technicians, was necessary and another consultant was hired for technician training, mix design and certification. This consultant also trained NDOR personnel in the new methods of testing and ways to help control mixes during production. The end result was the contractor's responsibility and generally produced better roadways.

By the year 2000, Superpave was the only mix type specified for asphalt surfacing, including rebuilds and overlays. In May of 2000, three tied project were started using an SP-2(0.5) mix design. The three tied projects were EACSTPD-43-2(106) Adams to Bennet, RD-S55G (1007) Hickman Spur and RD-S34B (1002) Firth Spur with the Adams job starting first. The project was started using a PG 58 -28 binder from Koch Material at 5.00% (by weight of mix). The roadway surface was milled and the new asphalt was to be laid in 2 lifts of 2" each. The first and second lifts went down smoothly with air voids between 3.2 to 4.0% and VMA of about 14.4 to 15.0%. FAA on the original design was 43.5 and during construction, using the burn-off, it still ran in the 42's. Just after July 4, 2000 the Firth Spur was started, using the same design. During this time period we had very hot and humid weather and things began to change. The Adams project started flushing and by the 8th of July the Firth project had been stopped to see what the problem was so it didn't continue. Cores were taken, evaluated and

NDOR could find nothing out of the ordinary except that now, where the top lift had originally been about 5.00% binder, it was now between 6.50 and 10.00%. After splitting the cores on the lift line, the bottom still contained about 5.00%. When looking at some places on the project, a person could take a spade and scrape off about 1/8" to 1/4" of pure binder for thirty or forty feet at a time. In other spots no flushing was noted. A letter was sent to the contractor to ask what course of action he was going to take to alleviate the problem. An upgrade in PG binder was suggested and the job was switched to PG 64 -22 from Trifinery. The project resumed August 22nd with the new binder and shut down again with the same problem on the Firth job August 24th. The mix was now totally redesigned, pulling the limestone screenings and replacing with millings from the project. The project resumed September 8 and no further flushing was found on the rest of that project, nor the Hickman Spur project.

Over the next couple of years, more projects with SP-2 designs were found to be flushing. During the Bennet project several cores were taken and kept in storage. Since the department had done all the testing it could do and really found nothing, some of the cores went to Western Research Institute in Laramie, WY. and some to the North Central Superpave Center at Purdue University in West Lafayette, IN. to see what they could find. Nobody could come up with anything conclusive as to why our SP-2's were flushing. In 2003, the department decided that the flushing possibly was result of our fine sands. Since the SP-2's FAA was only 40, the specification was changed to 43 and seemed to alleviate some of the problems with these mix designs. In 2003, a new mix was tried and later used exclusively, for all low volume roadways. It had all the properties of an SP-4 with the exception of the gyrations which were like our SP-2 at 117. It was called an SP-4 Special, tried on a few projects in 2003 and from then on has taken the place of our SP-1's, 2's and 3's. During 2002 the University of Nebraska (UNL) was developing an asphalt research program in conjunction with the Department of Roads and their first project was the SP-2 flushing project. The UNL project was finished in the year 2005 and their conclusions were about like everyone else's. There was not a clear cut answer as to why the SP-2 mixes flushed.

Over time, Superpave mixes started to show stripping problems. A liquid anti-strip was added to the mix but the quality and variability between producers was great. Contractors had been adding their own anti-strip at about 0.5% to percent total binder (The quality of the anti-strip varied.) About 2002, the department found that some anti-strips were not compatible with the binders being used. At that time, we made it the responsibility of the binder producer to add and certify that the correct amount was added before the contractor received the binder for a project.

The department also found that binder producers were using polyphosphoric acid to modify the upper temperature of their PG binders, to reduce the cost of real polymers. The acid was a lot less expensive and the upper temperature specifications could be met using the acid. The problem was, they didn't produce the highly modified binders were specified. The other concern, was that acid modification would react with limestone and increase stripping over time. The modified binder specification was changed and producers could only incorporate a blend of base asphalt and elastomer modifiers of styrene-butadiene (SB), styrene-butadiene-styrene (SBS) or styrene-butadiene-rubber (SBR). No acid could be used.

In 2004, the department decided that liquid anti-strips did not meet moisture sensitivity requirements. The industry had been using hydrated lime, as an anti-stripping agent, for quite a while. Nebraska had done some experimentation with hydrated lime and type 2 cement on a couple of earlier projects and it seemed to perform well. In late 2004, several projects were let with the option of using 1% hydrated lime in their mix designs as an anti-stripping agent and a specification was written. Originally the virgin aggregate was moistened and the hydrated lime was pug milled onto the aggregate, mixed thoroughly and dried, and then the % binder was added. By 2005, all mainline surface designs contained at least 1% hydrated lime and could be added by pug mill, lime slurry or premixed and stockpiled for use during the project.

Also in 2005, some contractors asked the department if they could verify their designs during the construction process instead of submitting verification samples to the Lincoln Lab. After some discussion it was decided that it would be tried on a few project and the mix design would be verified in the 1000 ton test strip by the NDOR Branch Lab closest to the project. By 2006 all project were handled in this way and it seemed to work well.

Chapter 12: Project Numbering

Date: 1- 2018

Source: <https://dotspot.nebraska.gov/media/1136/60-all.pdf>

Nebraska Department of Transportation
Operating Instruction 60-04
January 16, 2018

PROJECT NUMBERING

- ***
1. **Purpose:** To provide policy for numbering highway construction projects. The office of primary responsibility is the Program Management Division. This DOT-OI supersedes DOT-OI 60-04 dated January 10, 2018.
 2. All project numbers consist of three major parts:
 - A. In part one, the **Prefix** indicates the appropriation type of the highway system. See attachment #1.
 - B. The second part is the **Route Number/Zone** field, consisting of not more than four characters. For projects on the state highway system, the first three characters are the state highway **route number**. The final character is the **zone** of the route in which the project begins. Zones are established for the state from west to east and from south to north. Each state highway is assigned a direction for zoning purposes. Zones for the interstate system differ from those on the rest of the highway system. See attachments #3 and #4. Projects off the highway system, but on a federal-aid route, use the four-character federal-aid route number as the second part of the project number. For projects off the state highway system, all four characters are in a single entity and have no relationship to highway route numbers or zones. They instead reference the county or indicate that the project is statewide.
 - C. Part three is the **Unit** number consisting of not more than four characters. Numbering is sequential within each zone by highway route number. Projects not on the highway system and federal-aid interstate projects begin their sequential series with number 1. Other federal-aid projects on the highway system begin their series with number 101. Highway system projects not using federal funds (including interstate) begin their series with 1001. Projects that contain four characters in part three of their project number *do not* involve federal funds.

When inputting project numbers into the PPM computer system, an eight-character standard is used, consisting of the 4-character Route/Zone field and the 4-character Unit field. Prefixes, dashes and parenthesis are omitted and preceding zeros are used as placeholders, e.g.: NH-80-4(110) is coded as 08040110.

Prefix	Route Number	Zone	Unit	Written On Plans and Other Documents	Input into PPM
STP	84	6	106	STP-84-6(106)	08460106
BRO	7084		5	BRO-7084(5)	70840005
HSIP	STWD*		30	HSIP-STWD(30)	STWD0030

*Note that the STWD references the location of the project (statewide) and is not part of the prefix.

12.1 Project Prefixes

Project Prefixes

Federal-Aid Project Prefixes

Prefix	Description	Federal Participation Rate
<i>Federal Program Categories</i>		
NH	<i>National Highway Performance Program: Resurfacing, rehabilitation or reconstruction of highways designated as part of the National Highway System, including the Interstate.</i>	80% (90% on the Interstate if not used to add capacity)
BR / BH	<i>Federal-Aid Bridge - On System: Replacement (BR) or rehabilitation (BH) of bridges on the federal-aid highway system.</i>	80%
BRO / BHO	<i>Federal-Aid Bridge - Off System: Replacement (BRO) or rehabilitation (BHO) of bridges not on the federal-aid highway system.</i>	80%
STP	<i>Surface Transportation Program - Any Area: Construction, reconstruction, rehabilitation, resurfacing, restoration of federal-aid highways. These funds are generally used on non-NHS highways.</i>	80% (90% on the Interstate if not used to add capacity)
LCLC/ MAPA	<i>Surface Transportation Program - Urban Attributable: STP funds set aside for use in Nebraska's two metropolitan areas with a population over 200,000, Lincoln (LCLC) and Omaha (MAPA). These funds can be used for any of the purposes outlined under STP funds above.</i>	80%
URB	<i>Surface Transportation Program - Urban: STP funds set aside for use in Nebraska's first class cities (population between 5,000 and 50,000) These funds can be used for any of the purposes outlined under STP funds above.</i>	80%
TAP	<i>Transportation Alternatives Program: Used for various activities such as: bicycle/ pedestrian trails, landscaping, rehabilitation of historic structures and environmental mitigation.</i>	80%
HSIP	<i>Highway Safety Improvement Program: Used to carry out safety improvements on any public road or publicly owned bicycle or pedestrian trail.</i>	90%
RRZ	<i>Rail Highway Hazard Elimination Program: Used to construct new grade separation structures.</i>	90%
HRRR	<i>High Risk Rural Road Program: Used to carry out construction on roadways functionally classified as rural collectors and local roads.</i>	90%
RRX	<i>Rail Crossing Protection: Used to improve rail highway crossings</i>	90%
SRTS	<i>Safe Routes to School Program: used for projects to improve the ability of students to walk or bike to school.</i>	100%
SPR	<i>State Planning and Research: Used by NDOR for planning and research activities</i>	80%
PL	<i>Metropolitan Planning: Allocated to metropolitan areas to carry out transportation planning processes required by federal law</i>	80%
PLH/ FLH	<i>Public Lands Highways / Forest Lands Highways: projects within, adjacent to or providing access to public lands or forest highways.</i>	100%
DPS/ DPU/ EM	<i>Earmarks: Used for specific projects designated in federal legislation</i>	Varies
ER	<i>Emergency Relief: Emergency repairs and restoration of federal aid highways damaged by natural disasters or catastrophic failures.</i>	80% - 100%

Attachment #1

Project Prefixes

State Funded Project Prefixes

Prefix	Description	Comments
S	Resurfacing, rehabilitation or reconstruction of state highways	100% State Highway Cash Fund
SRR	Resurfacing, rehabilitation or reconstruction of roads into or within state parks and recreational areas	100% SRR funds for roads within parks, 90% SRR, 10% local for exterior roads
NFG	State grade crossing funds used for rail crossing protective devices and closures	100% NFG funds
TMT	Train Mile Tax: State tax on rail traffic used for constructing, rehabilitating, relocating or modifying railroad grade separation structures.	Up to 100% TMT funds
RD	Restoration and rehab projects such as armor coat, fog seal, joint and crack seal, asphalt and concrete patching	100% State Highway Cash Fund
STR	Minor structure work such as bridge or box culvert repair	100% State Highway Cash Fund
MISC	Minor projects such as culvert repair, landscaping or minor grading	100% State Highway Cash Fund
ELEC	Minor electrical projects such as lighting and traffic signals	100% State Highway Cash Fund

Attachment #1

12.2 Highway Numbers by Direction

Highway Numbers by Direction

Hwy. No.	Direction	Hwy. No.	Direction	Hwy. No.	Direction
1	West-East	38	West-East	83	South-North
2	West-East	39	South-North	84	West-East
4	West-East	40	West-East	85	South-North
5	South-North	41	West-East	87	South-North
6	West-East	43	South-North	88	West-East
7	South-North	44	South-North	89	West-East
8	West-East	45	South-North	91	West-East
9	South-North	46	South-North	92	West-East
10	South-North	47	South-North	94	West-East
11	South-North	50	South-North	95	West-East
12	West-East	51	West-East	97	South-North
13	South-North	52	South-North	98	West-East
14	South-North	53	South-North	99	South-North
15	South-North	56	West-East	103	South-North
16	South-North	57	South-North	105	South-North
17	South-North	58	South-North	109	South-North
18	West-East	59	West-East	110	South-North
19	South-North	61	South-North	112	South-North
20	West-East	62	West-East	116	South-North
21	South-North	63	South-North	121	South-North
22	West-East	64	West-East	128	West-East
23	West-East	65	South-North	131	South-North
24	West-East	66	West-East	133	South-North
25	South-North	67	South-North	136	West-East
25A	South-North	68	South-North	137	South-North
26	West-East	69	South-North	138	South-North
27	South-North	70	West-East	159	West-East
29	South-North	71	South-North	183	South-North
30	West-East	73	South-North	250	South-North
31	South-North	74	West-East	275	West-East
32	West-East	75	South-North	275B	West-East
33	West-East	77	South-North	281	South-North
34	West-East	78	South-North	283	South-North
35	South-North	79	South-North	370	West-East
36	West-East	81	South-North	385	South-North

Attachment #2

12.3 Non-Interstate Zone Map

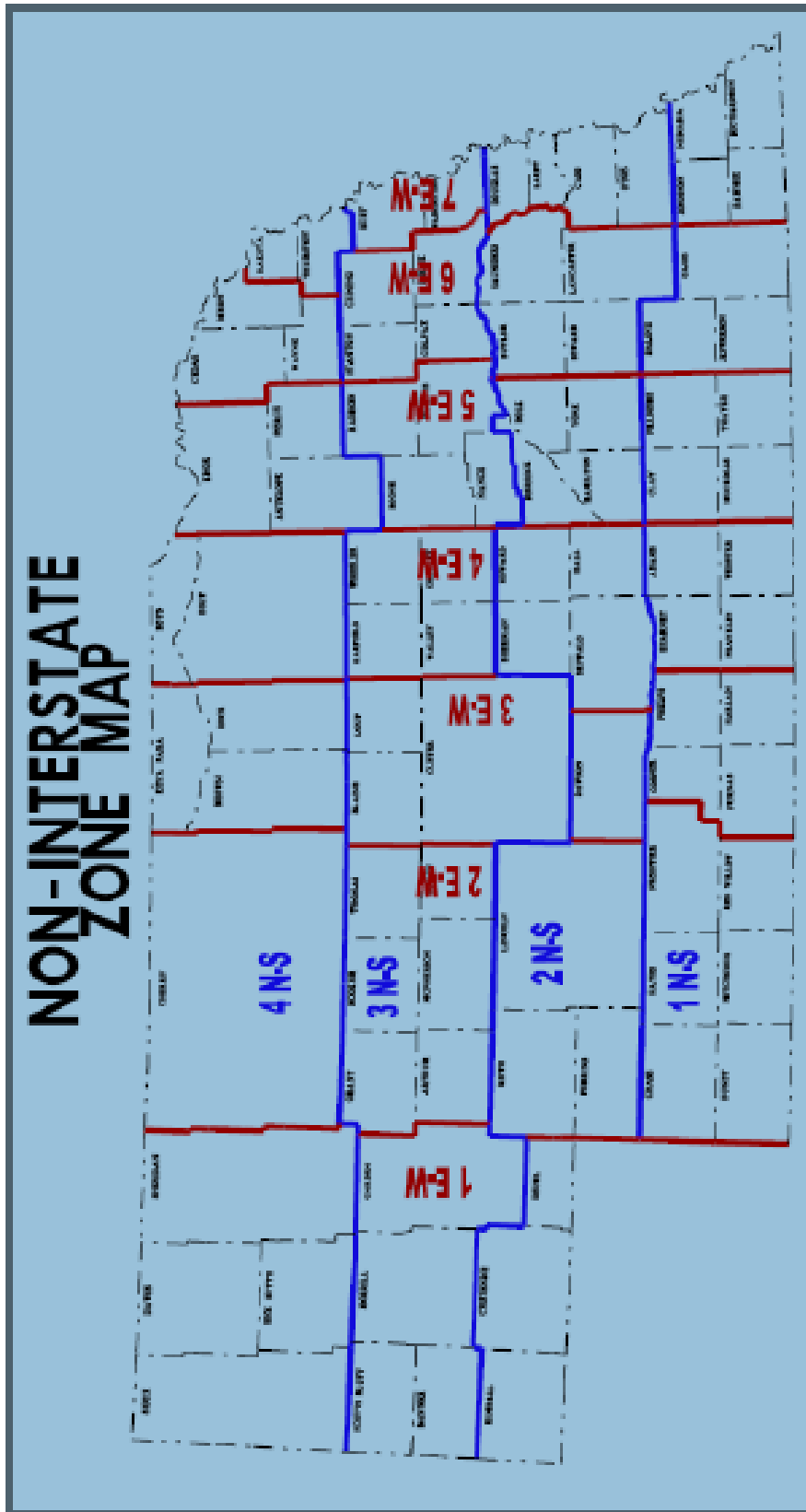

Attachment #3

12.4 Interstate Zones

Interstate Zones

Zone No.	Location	Interstate Route
1	Wyoming Line – Sidney	80
2	Sidney – I-76	80
3	I-76 – North Platte	76, 80
4	North Platte – Lexington	80
5	Lexington – Keamey	80
6	Keamey – Grand Island	80
7	Grand Island – York	80
8	York – West Lincoln	80
9	West Lincoln – Omaha	80, 180, 480, 680
1	South Sioux City Spur – Iowa Line	129

Attachment #4

12.5 Interstate Zone Map

INTERSTATE ZONE MAP

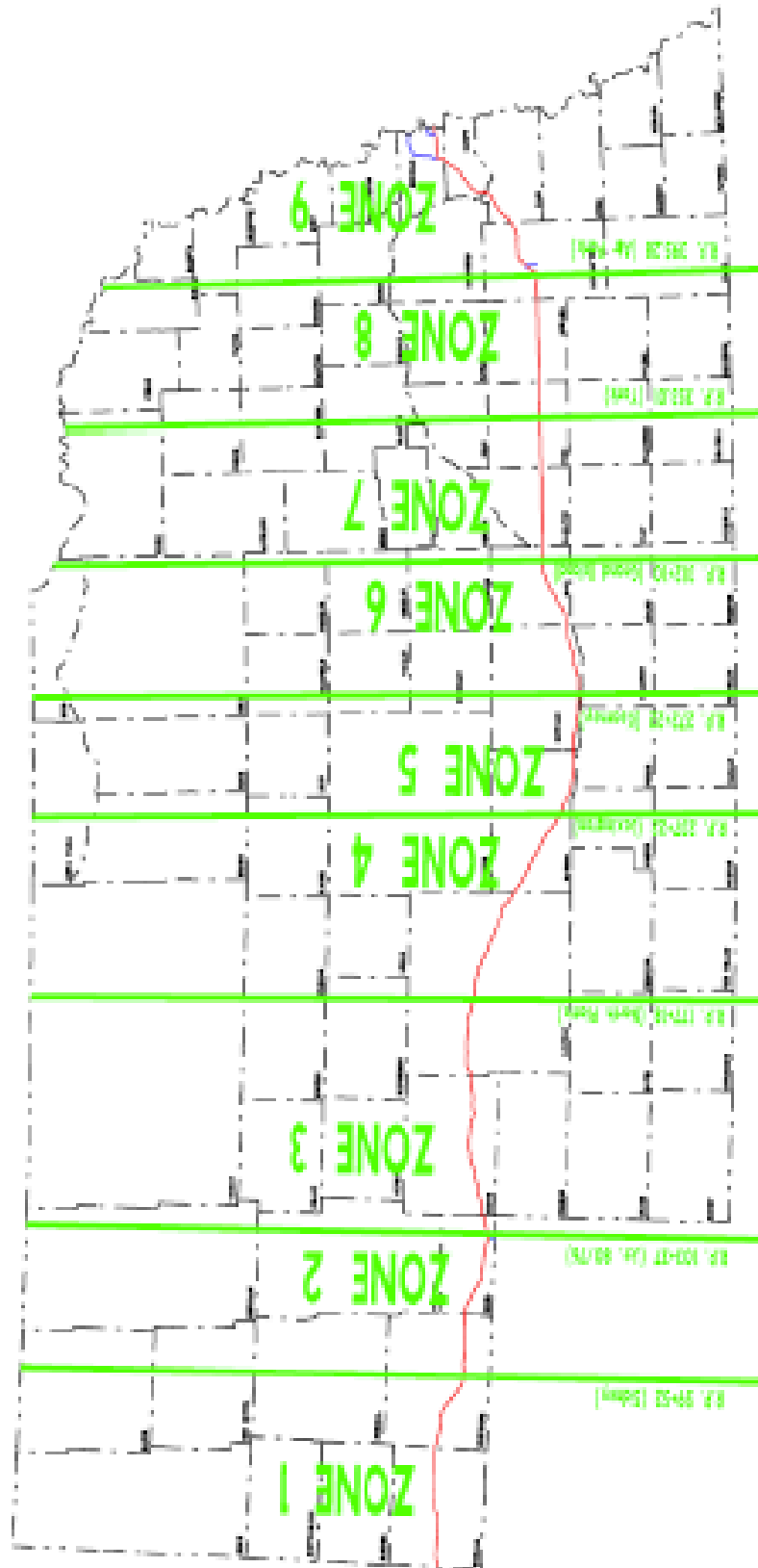

Attachment #5

Chapter 13: 28 Ft Surfaced Top

28 Ft Surfaced Top - Alternate Route System

Sandhills

Two 12' wide lanes, four feet wide shoulders of which two feet are surfaced.

US-30 - RP 0.00 to RP114.31 I-80 Parallel Alternate Route System

Two 12' wide lanes, four feet wide shoulders of which two feet are surfaced.

L50A - RP 0.00 to RP 7.00 I-80 Parallel Alternate Route System

Two 12' wide lanes, four feet wide shoulders of which two feet are surfaced.

Connecting Links on the Alternate Route System between I-80 and the Parallel Alternate Route System

Two 12' wide lanes, four feet wide shoulders of which two feet are surfaced.

The links affected are those listed below. These are the links that are on the Alternate Route System and do not meet any other Need Criteria for a 28' top.

Highway Number	Length	Location
L10B	1.98	Odessa
L10C	2.5	Gibbon
L10D	3.99	Shelton
L40C	5.83	Alda
S41B	3.31	Giltner
S93A	4.39	Henderson

The approved Needs Criteria are applied to the statewide system to determine the geometric needs. These are not design standards and should not be used as such.

Approved this 21st day of January, 2010



Randall D. Peters
Deputy Director – Engineering Services

Discussion on Warrants for 28 ft Surfaced Top for a Specific Roadway Segment

Source: Excerpt of email from Jim Knott dated 12/14/2012

When I receive these requests I review five things.

- 1) **The existing shoulder condition.** This evaluation is subjective and based upon a visual review from Pathweb Roadviewer. The roadway shoulders on N-71 between MM 81 and 90 appear to be in good condition with no apparent drop-offs except through some of the sharper horizontal curves.
- 2) **The costs to maintain the shoulders over the past five years.** This evaluation is objective and based upon a review of the maintenance costs in the Integrated Highway Inventory. This measure indicates two things. One, is the amount effort the District has had to spend to maintain the shoulders over the past five years. Two, the priority the district has placed upon the shoulders on this segment of highway. Over the past five years, the district has spent approximately \$2,500 over a period of two years for approximately 18 miles or 36 shoulder miles for an average of \$34 per shoulder mile per year. Based upon the current condition of the shoulders I would say that they do not experience much annual deterioration. The last information I have on costs indicates it costs about \$50,000/mile to add the additional 4' of widening. At that rate it would take approximately 715 years to recoup the costs based upon annual shoulder maintenance costs.
- 3) **Traffic Volumes.** This evaluation is objective and is based upon the information in the Pavement Optimization Program (POP). The warrant for 28' top is a roadway that exceeds 2,000 vehicles per day on average. Sometimes, while the roadway may not warrant a 28' top it will be close and a large volume of trucks may create a situation where a 28' top can be appropriate. The current traffic is 780 vpd and the 20 year projected traffic is 1,092 vpd with approximately 13% trucks. Since this would be a 3R project we would use a 10 year traffic which would be approximately 910 VPD. This is not very close to the warrant.
- 4) **Adjacent land use.** This is an objective review based upon a review of Google Earth and Pathweb Roadviewer. In general, farm equipment that serves row crops is wider and have greater impact upon the turf shoulders than equipment used in ranching and pasture maintenance. In reviewing this segment of roadway and adjacent segments there is one center pivot at the north end where row crops are being raised. The remainder is ranch land.
- 5) **Crash history.** This is an objective evaluation based upon a review of the crashes recorded in NECTAR. I note crashes over the past six years that could be attributed to a shoulder drop off. In general, I look for roll over or overturning crashes. This segment of roadway recorded two crashes in the past six years that were recorded as rollover crashes.

As Brandie indicated in her email, continuity is not considered in the evaluation. Since the pavement determinations vary segment to segment there is no 28' top system and the 28' top occurs randomly across the state on unwarranted roadways based upon whether a particular roadway segment required a recycling strategy or not.

NDOT Pavement Design Manual