



No.	Location	Project	ROW	AFE	GR.	CONST. SEP.	PAV.	VIA.
1	State line — 5 1/2 mi. East	I-80-1(3)		493	(4)	(4)	(4)	
2	5 1/2 mi. East — Bushnell	I-80-1(5)		580	(21)	(22)	(23)	
3	Bushnell — Kimball	I-80-1(6)		636	(25)	(26)	(27)	
3a	Kimball — Kimball S.E.	I-80-1(7)			(30)	(31)	(32)	
4	Kimball S.E. — Dix	I-80-1(8)			(33)	(34)	(35)	
5	Dix — Potter	I-80-1(9)			(36)	(37)	(38)	
6	Potter — Brownson	I-80-1(10)			(46)	(47)	(48)	
7	Brownson — Sidney West	I-80-1(11)			(43)	(44)	(45)	
7a	Sidney W. — Sidney Airport	I-80-1(12)			(39)	(40)	(41)	(42)
8	Sidney Airport — Sunol	I-80-2(6)			(28)	(29)	(30)	
9	Sunol — Lodgepole	I-80-2(5)			(25)	(26)	(27)	
10	Lodgepole — Chappell	I-80-2(4)	675		(22)	(23)	(24)	
11	Chappell — Oshkosh	I-80-2(3)	625		(18)	(19)	(20)	(21)
12	Oshkosh — I-80S	I-80-2(2)	601		(15)	(13)	(16)	(14)
13	Colorado Line — I-80S	I-80S-3(46)	564		(32)	(33)	(34)	
14	I-80S — Big Springs	I-80-3(42)	562		(28)	(29)	(30)	
15	Big Springs — Brule	I-80-3(41)	531		(25)	(26)	(27)	
16	Brule — Ogallala	I-80-3(4)	439		(22)	(23)	(24)	
17	Ogallala — Roscoe	I-80-3(37)	537		(19)	(20)	(21)	
18	Roscoe — Paxton	I-80-3(36)	571		(16)	(17)	(18)	
19	Paxton — Sutherland	I-80-3(3)	438		(13)	(14)	(15)	
20	Sutherland — No. Platte	I-80-3(2)	437		(10)	(7)	(11)	(8)
21	No. Platte — Diversion	I-80-4(3)	355		(25)	(21)	(24)	(23)
22	Diversion — Cozad	I-80-4(8)(12)	247b,167b		(15)	(17)	(18)	(14)

No.	Location	Project	ROW	AFE	GR.	CONST. SEP.	PAV.	VIA.
23	Cozad — Lexington	I-80-4(3)(12)	246b,167b		(4)	(5)	(6)	(7)
24	Lexington — Kearney	I-80-5(2)(11)	144b,168b		(7)	(3)	(10)	(9)
25	Kearney — Wood River	I-80-6(7)(9)	70b,169b		(13)	(12)	(15)	(14)
26	Wood River — Grand Island	I-80-6(3)(9)	31b,169b		(4)	(5)	(6)	
27	Grand Island Interchange	I-80-7(10)(4)	32b,170b		24	(25)	(26)	(29)
28	Grand Island — York	I-80-7(3)(4)	307b,170b		21	(17)	(14)	(22)
29	York — Milford	I-80-8(2)(13)	221b,171b		(10)	(8)	(12)	(11)
30	Milford — Pleasant Dale	I-80-8(9)(13)	33b,171b		(12)	(12)	(12)	
31	Pleasant Dale — LAFB	I-80-8(10)(13)	34b,171b		(11)	(11)	(11)	
32	LAFB — West Lincoln	I-80-9(24)(94)	831a,172b					
33	West Lincoln — I-80 West Hwy 77	I-80-9(25)(94)	814a,172b					
34	I-80 — Oak Creek	I-80-9(74)	986a					
35	Oak Creek — "R" Street	I-80-9(75)	986a					
36	1 mi. west Hwy 77 — Waverly	I-80-9(16)(94)	802a,172b					
37	Waverly — Greenwood	I-80-9(6)(94)	813a,172b					
38	Greenwood — Gretna	I-80-9(4)(94)	872a,172b					
39	Gretna — Hwy 370 Inter.	I-01-09(1)(94)	703a,172b					
40	Hwy 370 Inter. — Douglas Co. Line	I-01-09(20)(94)	715a,172b					
41	Douglas Co. Line — Tri Level	I-80-9(23)(94)	767a,172b					
42	Tri-Level — 96th Street	I-80-9(7)	797a					
43	96th Street — Mo Pac RR	I-80-9(10)	838a					
44	Mo Pac RR — Hactor Blvd	I-80-9(14)	895a					

No.	Location	Project	AFE
45	Hactor Blvd. — 20th Street	I-80-9(30)	541
46	20th Street — 15th Street	I-80-9(150)	598
47	15th Street — 10th Street	I-80-9(171)	611
48	10th Street — Riverview Blvd	I-80-9(172)	612
49	Riverview Blvd — Missouri River	I-80-9(179)	656
50	Frederick St. — Harney St.	I-480-9(26)	907a
51	Harney St. — 1/2 blk. no. Dodge St.	I-480-9(27)	80b
52	1/2 blk. no. Dodge — Davenport St.	I-480-9(66)	248b
53	No. pt 28th & Dodge Inter.	I-480-9(109)	249b
54	23rd Street — 20th Street	I-480-9(137)	504
55	20th Street — 17th Street	I-480-9(138)	505
56	17th Street — 14th Street	I-480-9(139)	514
57	14th Street — 11th Street	I-480-9(142)	520
58	11th Street — 9th Street	I-480-9(143)	529
59	Missouri River Bridge Approach	I-480-9(119)	362
60	Tri-Level — Dodge St.	I-880-9(28)	822a
61	Dodge Street Interchange	I-880-9(31)	857a
62	Dodge St. — Fort St.	I-280-9(32)	81b
63	Fort St. — Thomas Creek	I-680-9(77)	502
64	Thomas Creek — 35th St.	I-680-9(165)	645
65	35th St. — Missouri River	I-680-9(173)	637

Advertising unit has AFE's shown as second as in columns 3 & 4, where they differ from ROW unit no.

STATE OF NEBRASKA DEPARTMENT OF ROADS

RIGHT OF WAY DIVISION RIGHT OF WAY DESIGN

*Previous Right Of Way Projects
Shown In Each District*

*Right Of Way Engineer
Dan Foreman*

*Right Of Way Assistant Engineer
Andre Sahele*

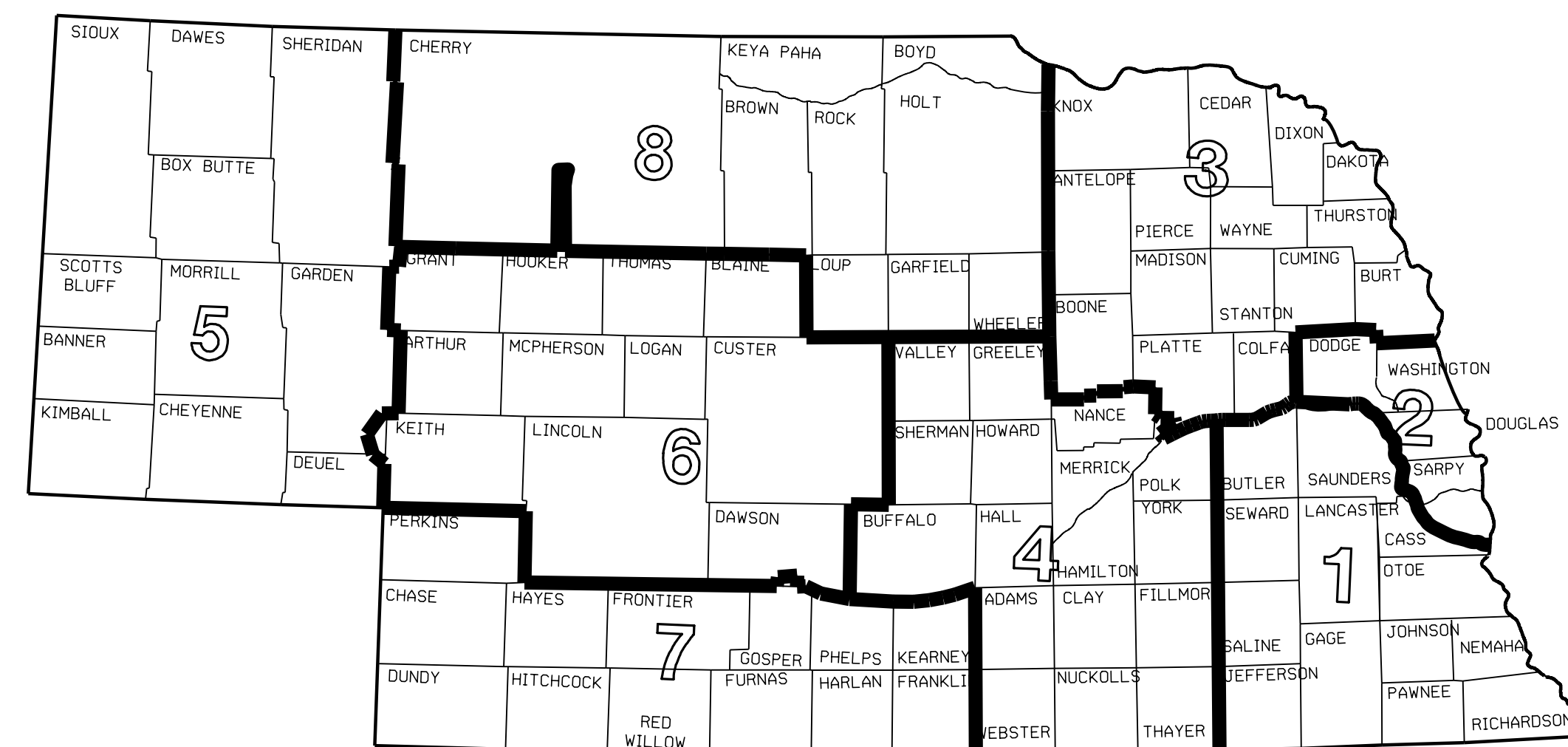

*Current as of June 23, 2026
by Jazmine Falls*

*can be viewed In OnBase under:
ROW Design > ROW Design Archive > ROW Design Archive Index*

PROJECT NO.	SHEET NO.
DISTRICT I	
EXISTING R.O.W. PROJECTS	
SOUTH HALF	
CONTROL NO.	ROW

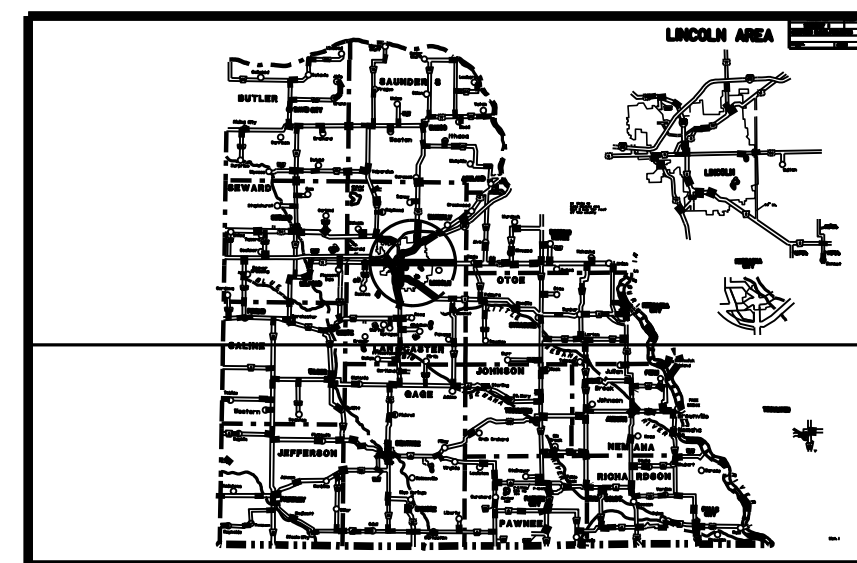

MAP DIVIDE KEY

TECUMSEH

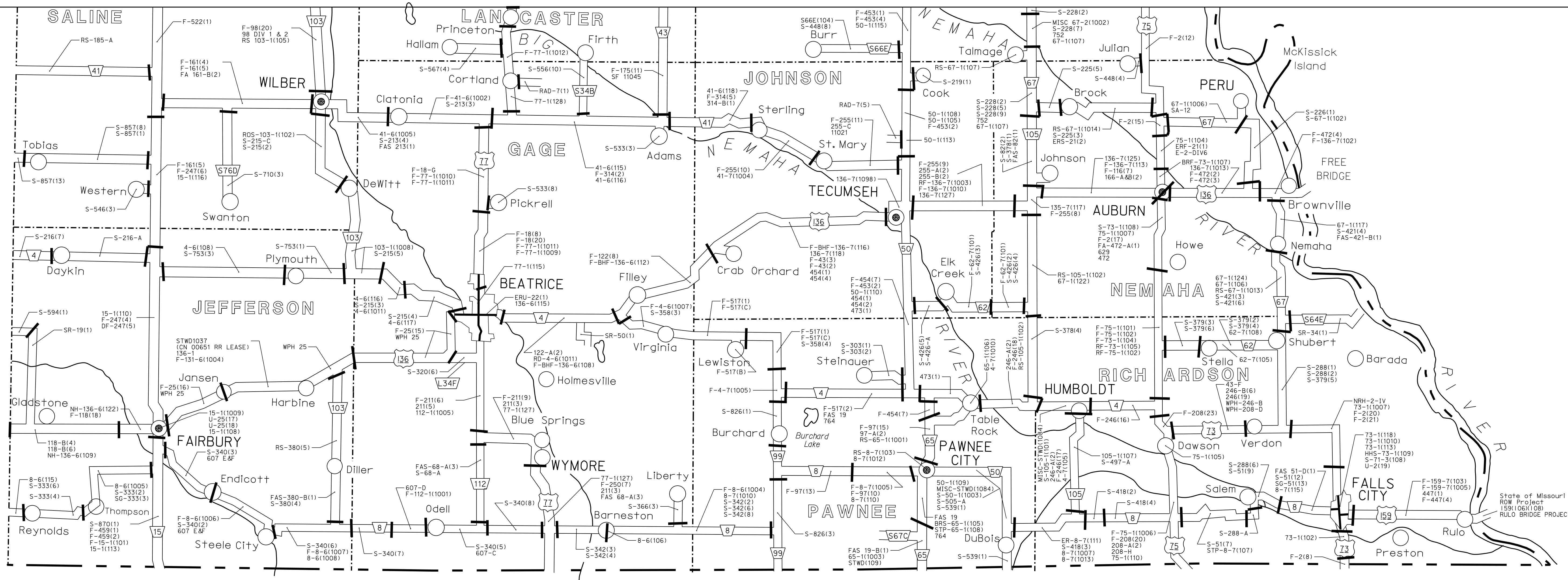
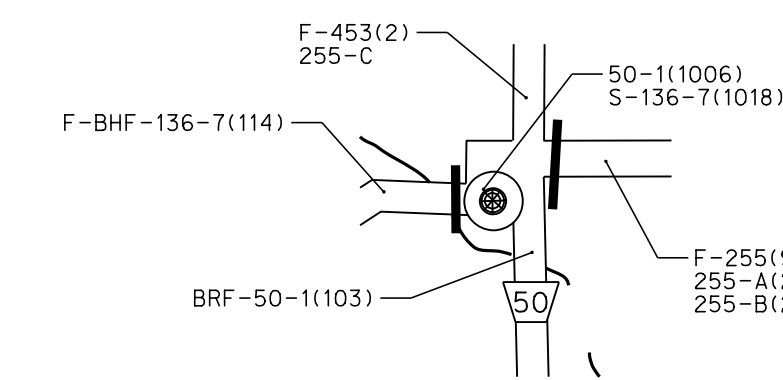

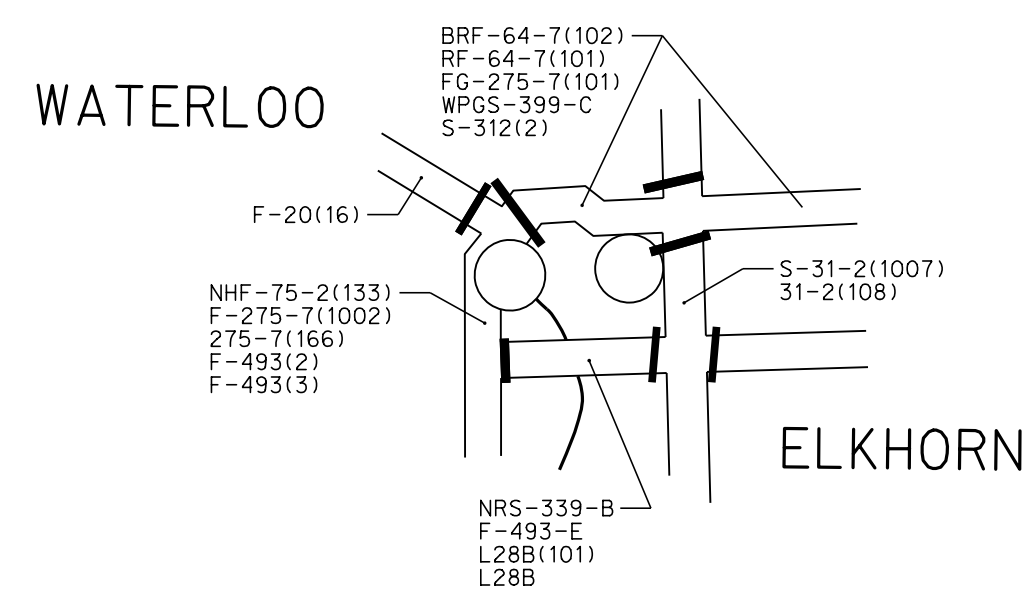
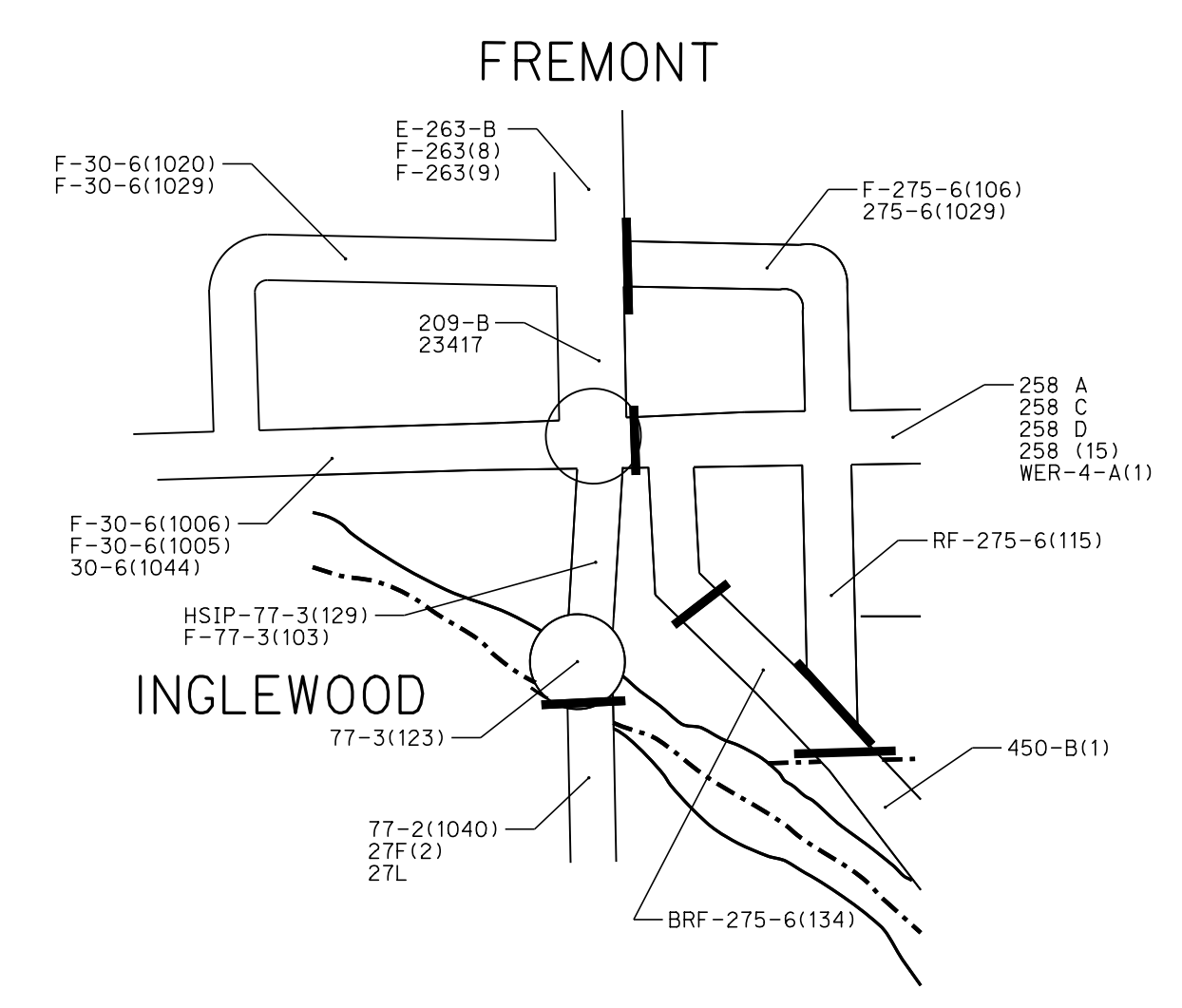
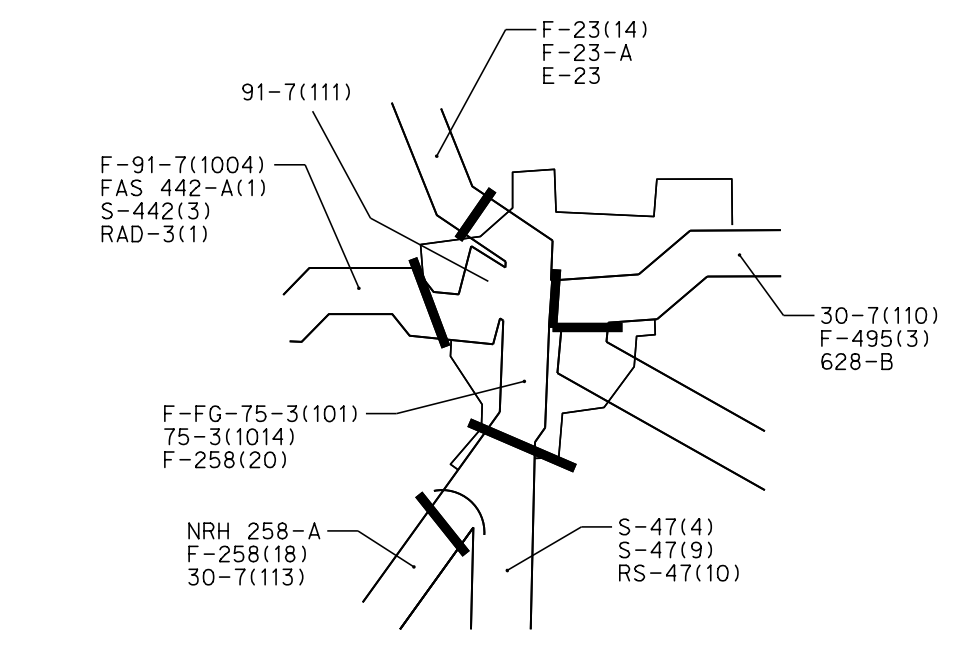
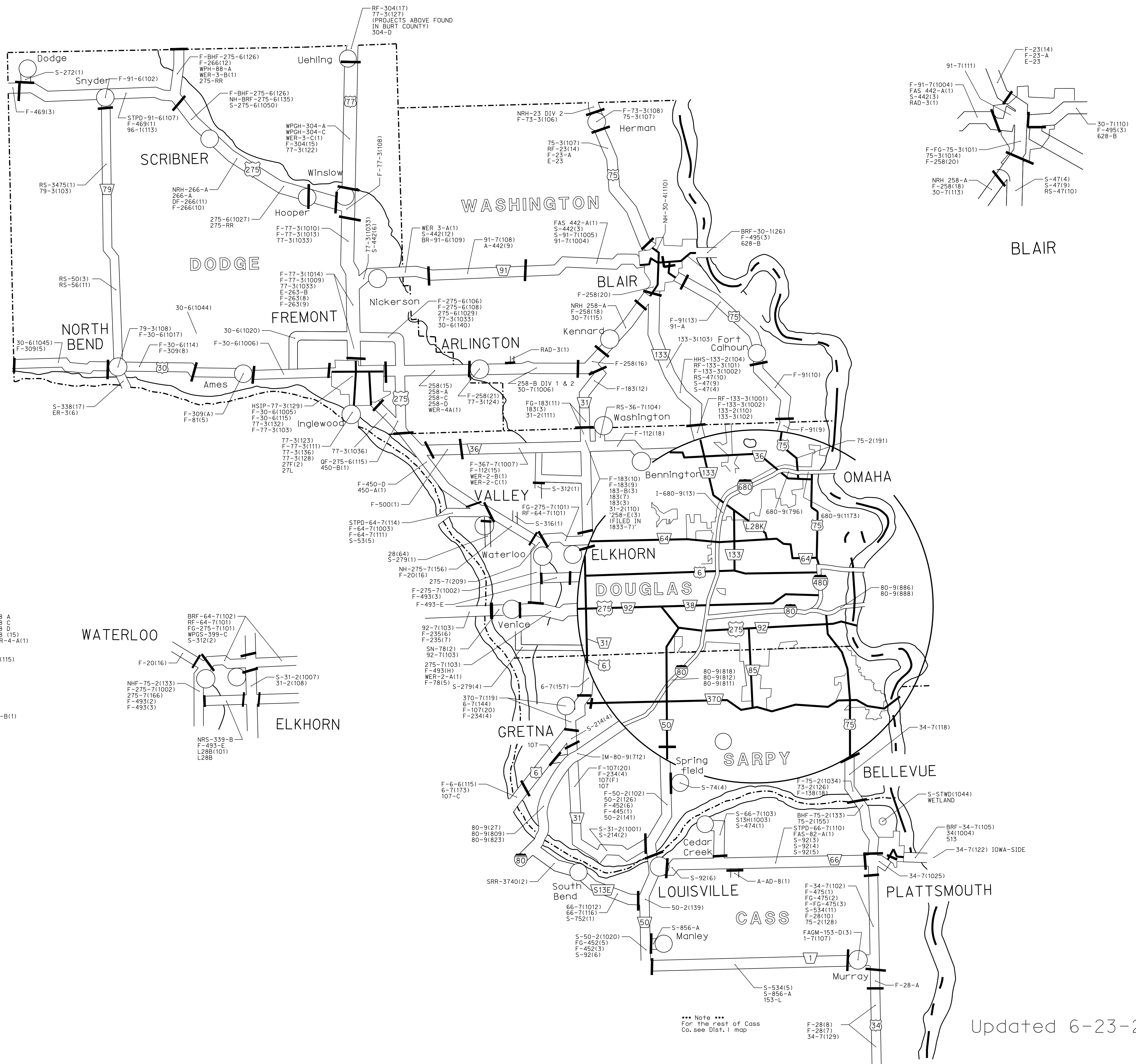

*** Note ***
For the rest of Cass
Co. see Dist. 1 map

Updated 6-23-2026

Dist. 2

PROJECT NO.	SHEET NO.
DISTRICT 2	
EXISTING R.O.W. PROJECTS	
CONTROL NO.	ROW

OMAHA AREA

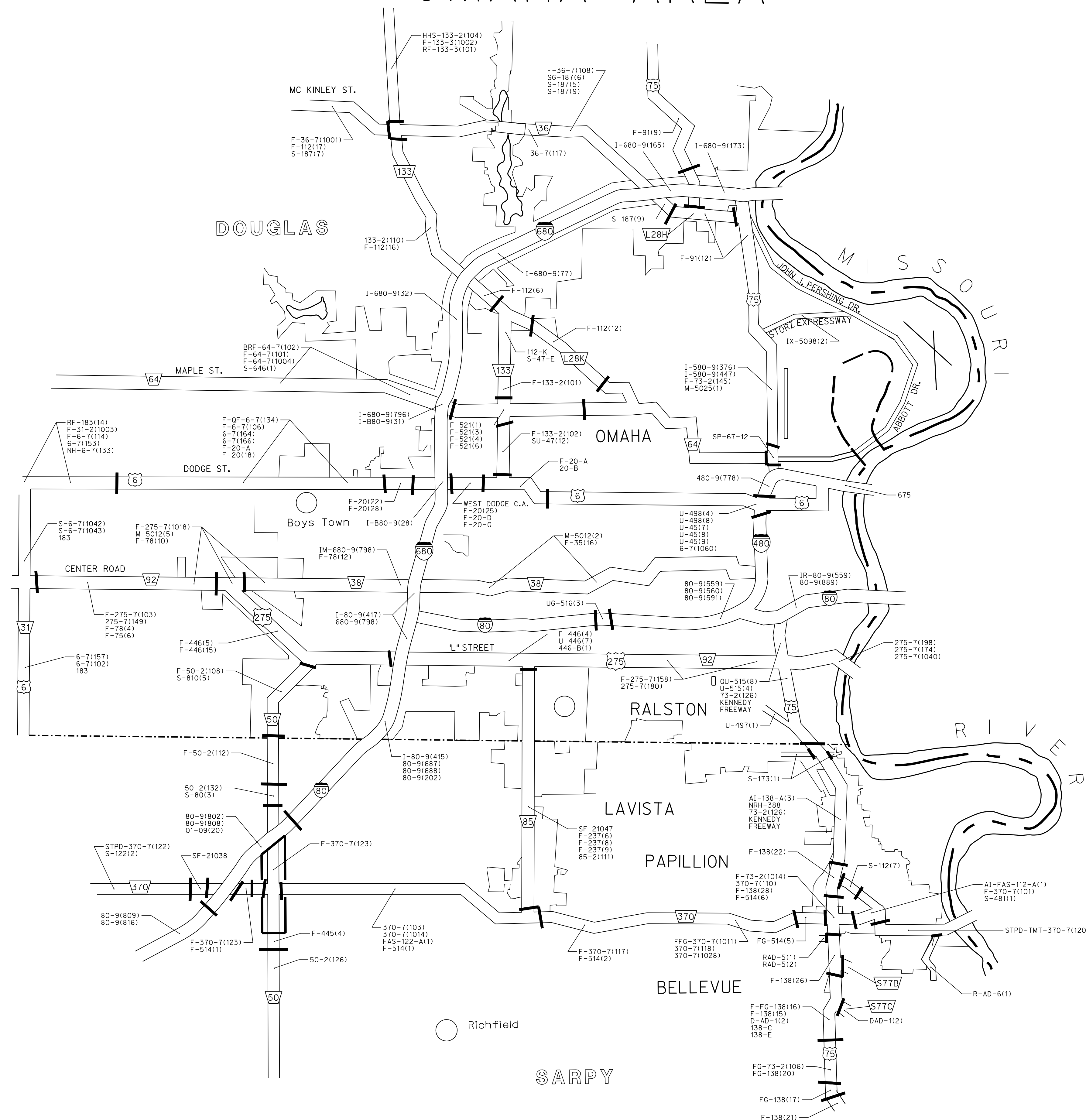

Updated 6-23-2026

Dist. 2

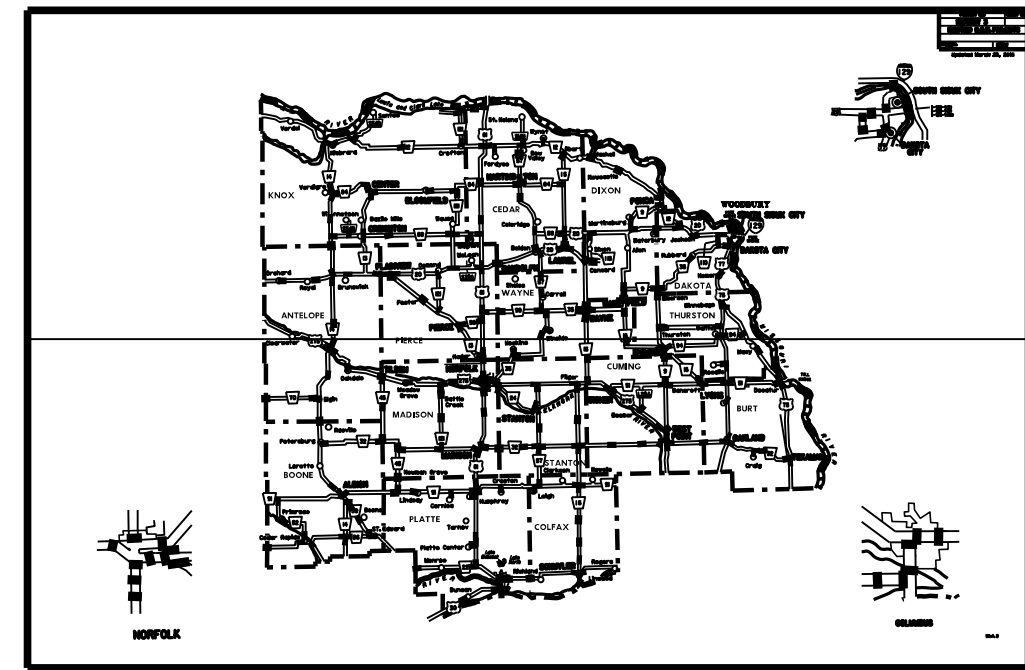

MAP DIVIDE KEY

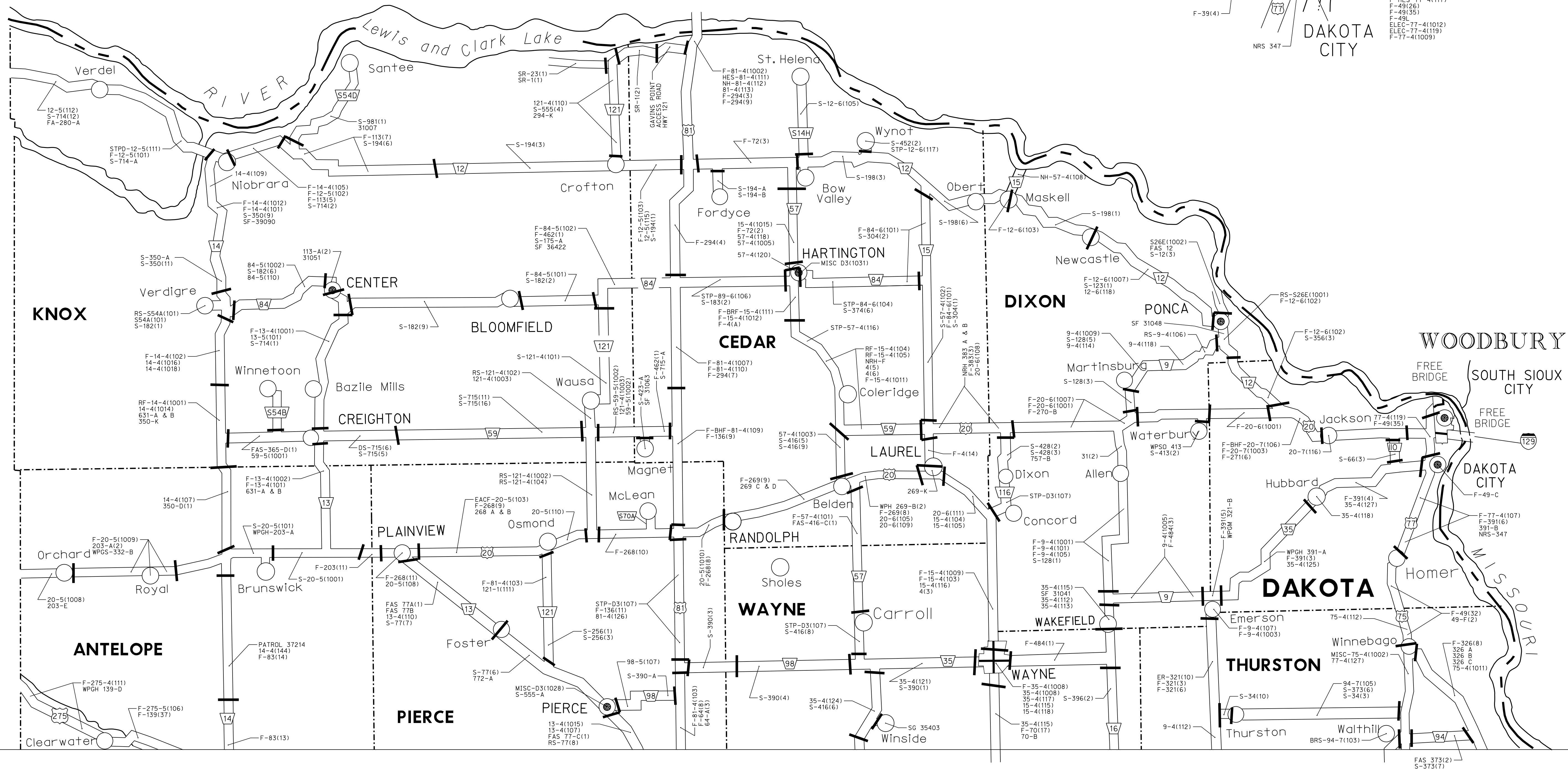
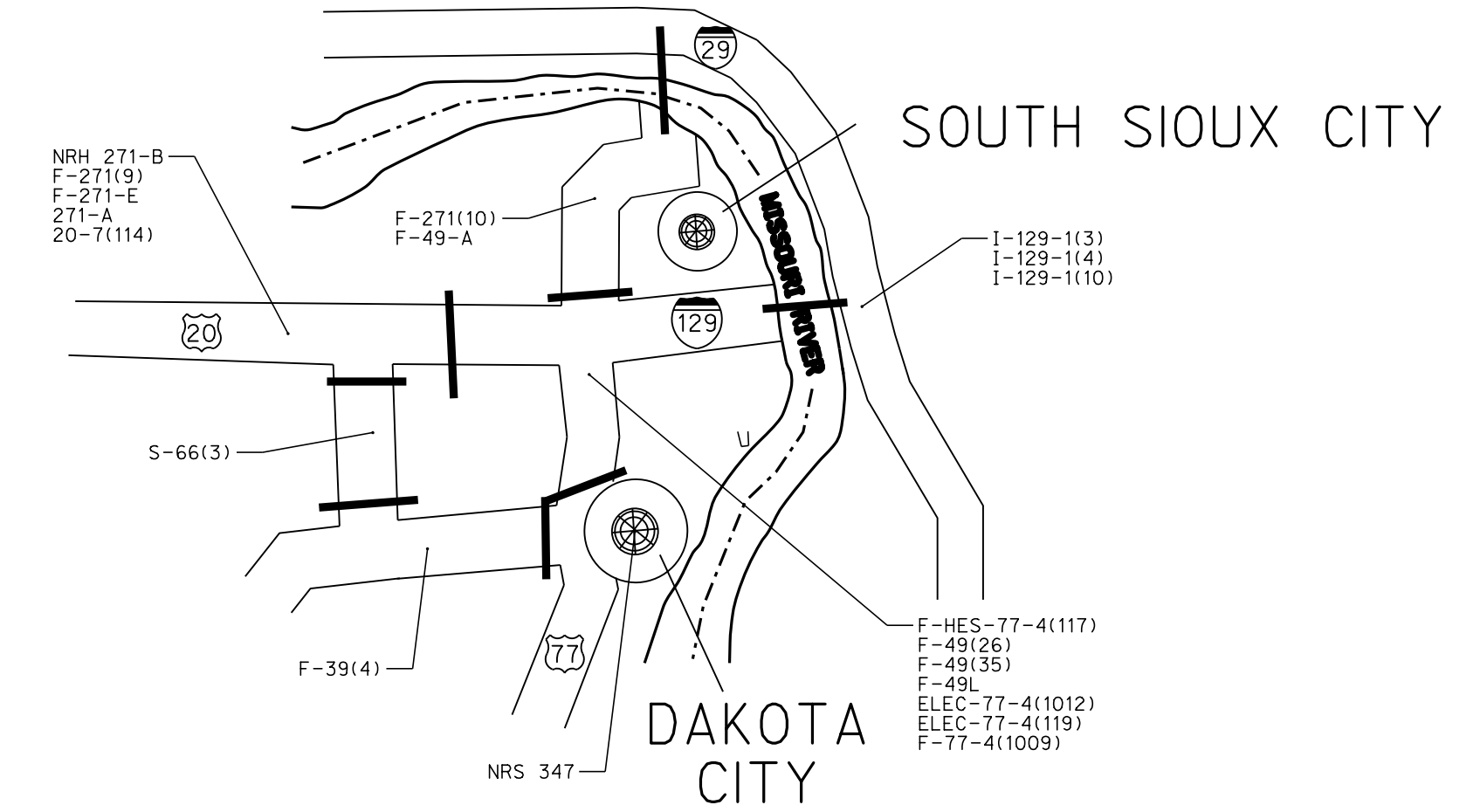

PROJECT NO.	SHEET NO.
DISTRICT 4	
EXISTING R.O.W. PROJECTS	
NORTH HALF	
CONTROL NO.	ROW

MAP DIVIDE KEY

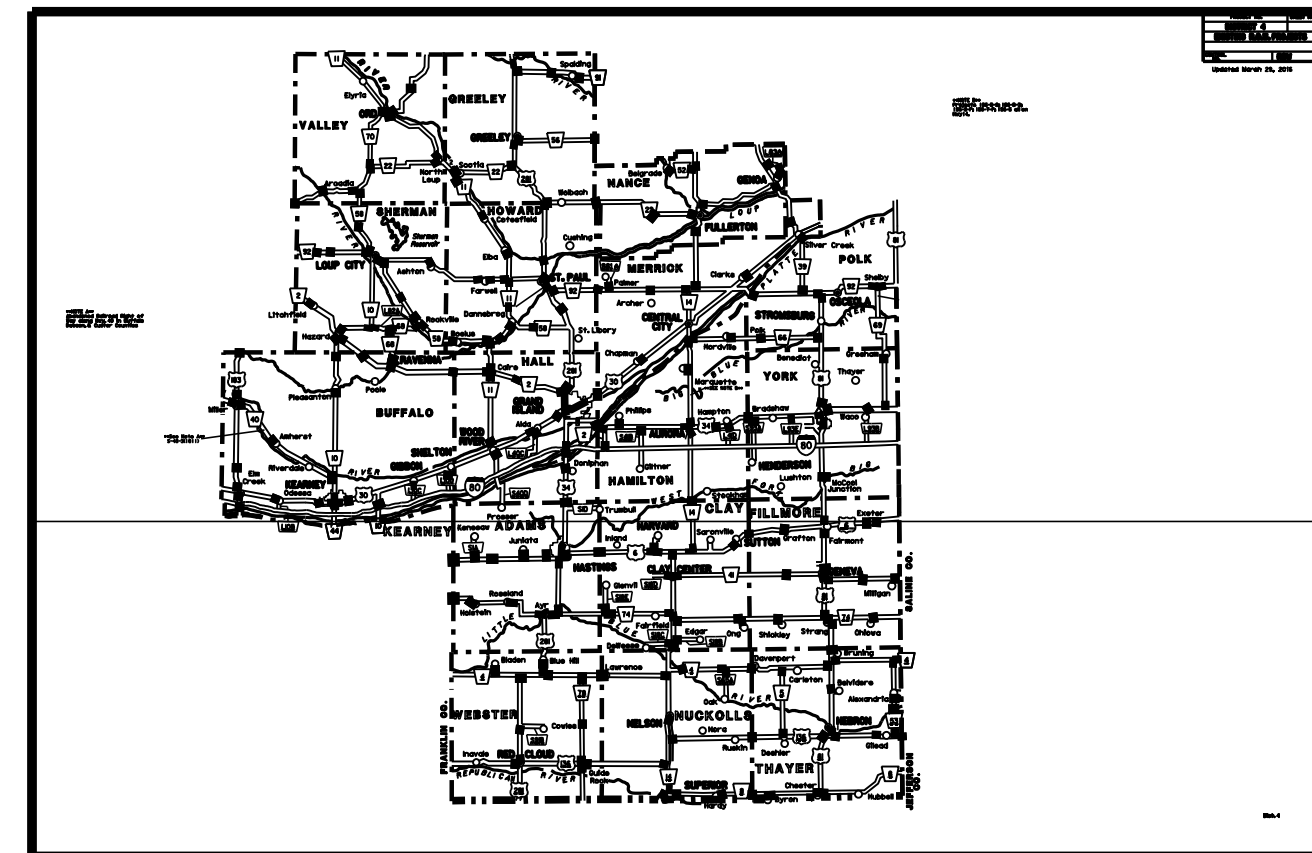

GRAND ISLAND

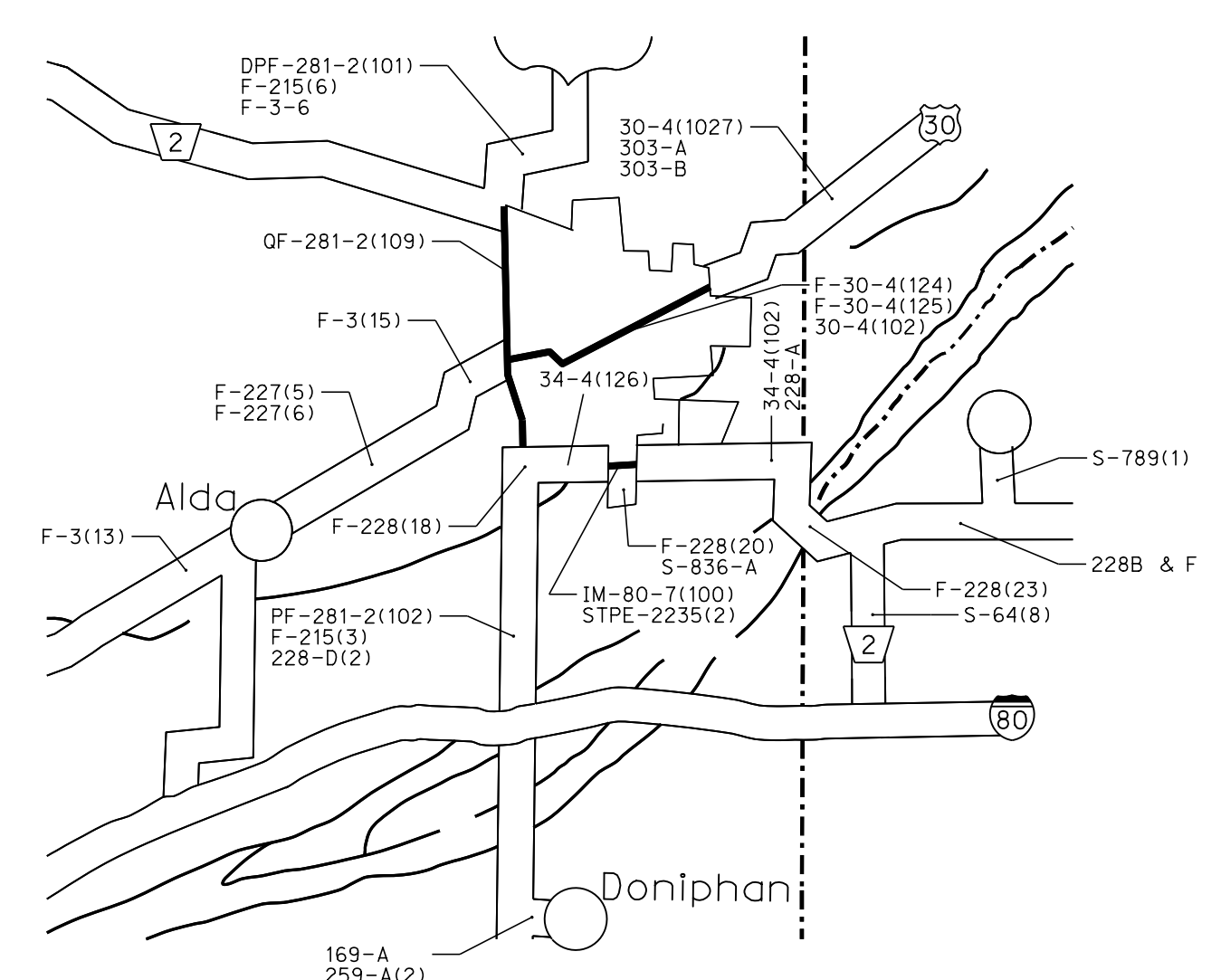

****NOTE A****
Abandoned Railroad Right of Way along Hwy. 40 in Buffalo Dawson & Custer Counties

****NOTE B****
Projects 156-B-2; 156-B-3; 156-2-F; 156-7-F; 156-5 all on Hwy 14.

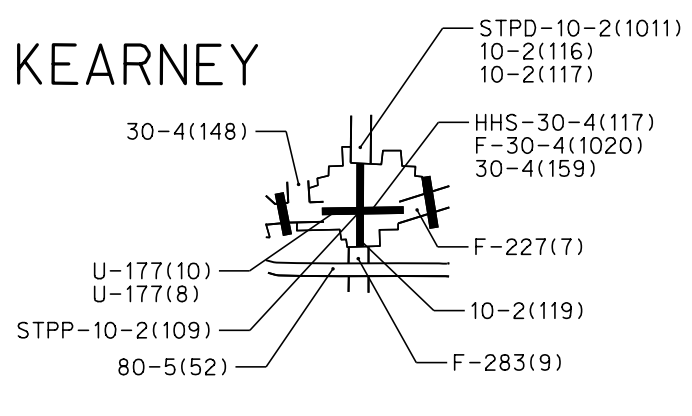
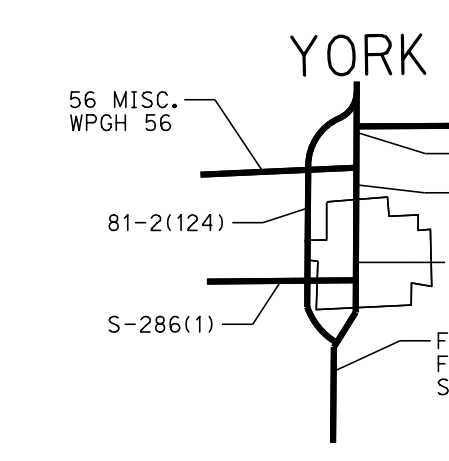
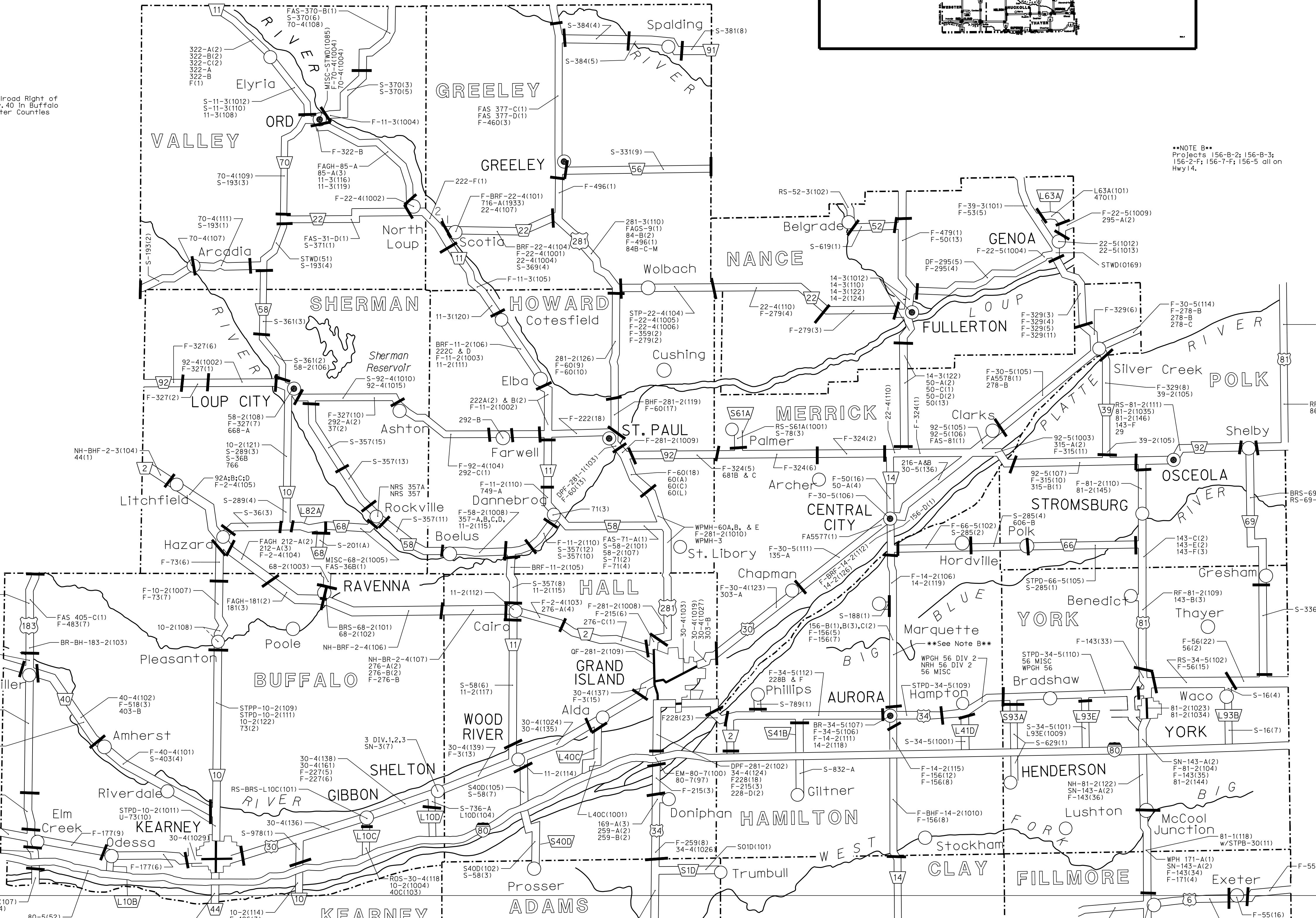

PROJECT NO.	SHEET NO.
DISTRICT #5	
EXISTING R.O.W. PROJECTS	
CONTROL NO.	ROW

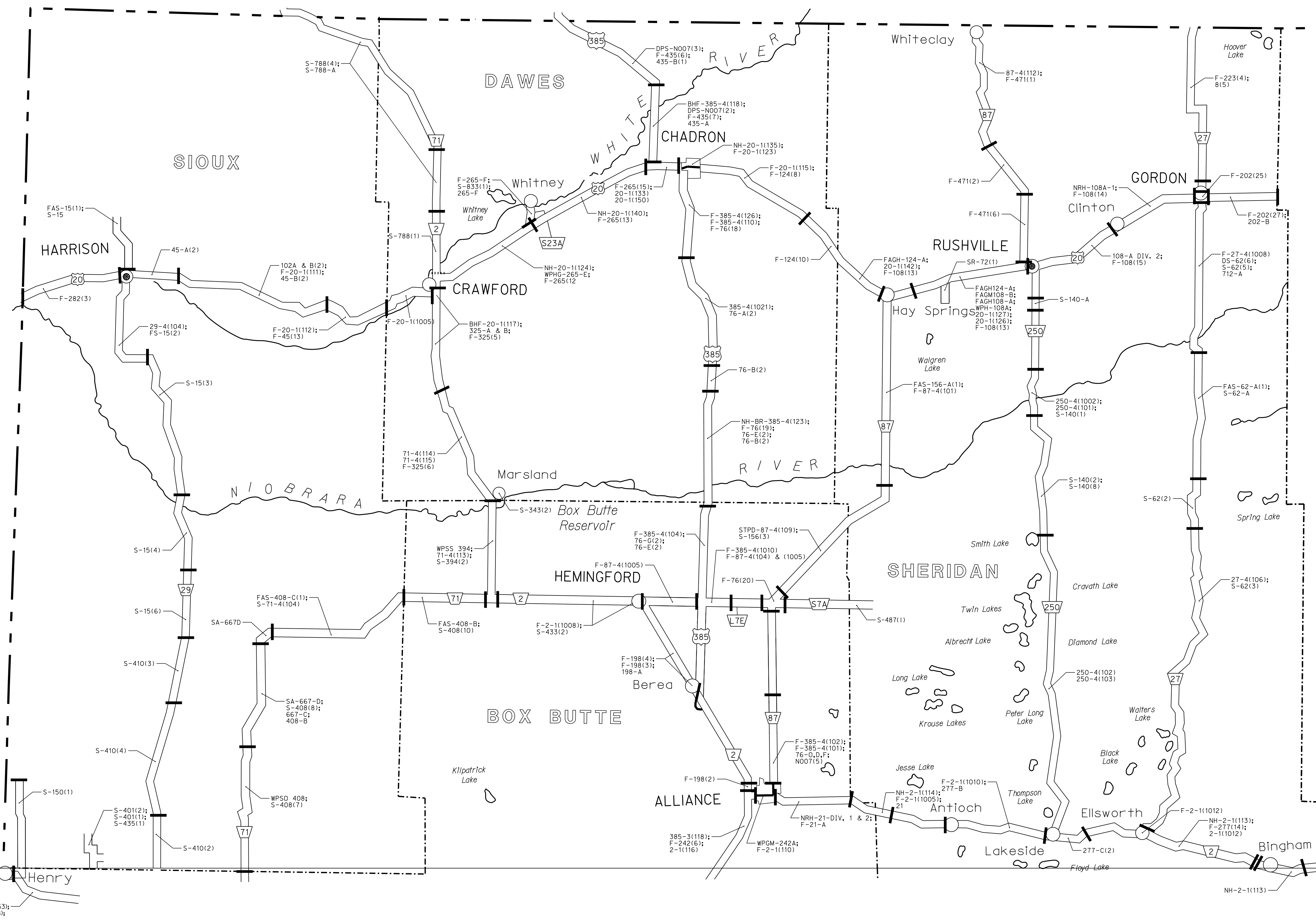

26-1(153);
F-300(B);
300-D

Updated 6-23-2026

Dist. 5

PROJECT NO.	SHEET NO.
DISTRICT #5	
EXISTING R.O.W. PROJECTS	
CONTROL NO.	ROW

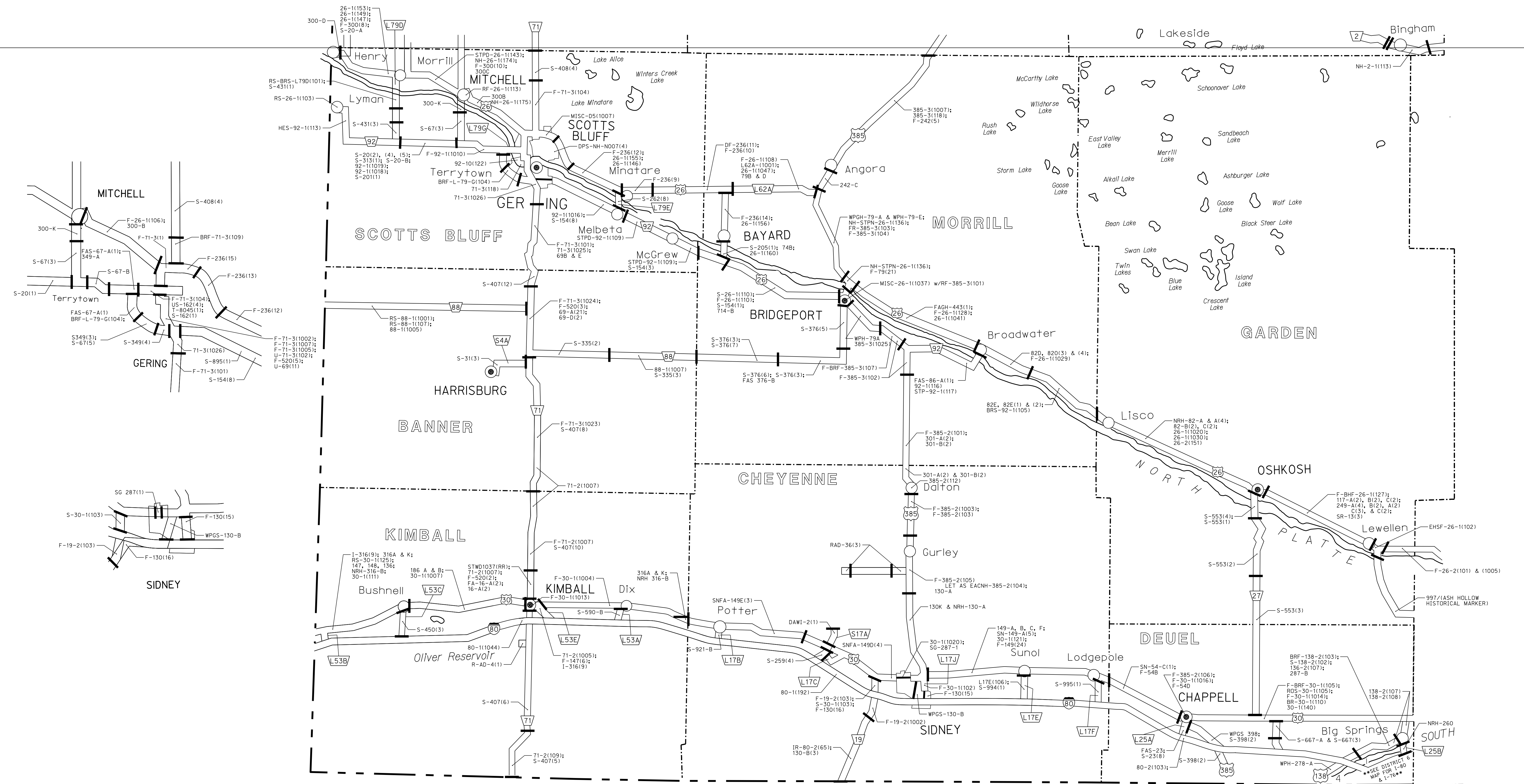

PROJECT NO.	SHEET NO.
DISTRICT 6	
EXISTING R.O.W. PROJECTS	
CONTROL NO.	ROW

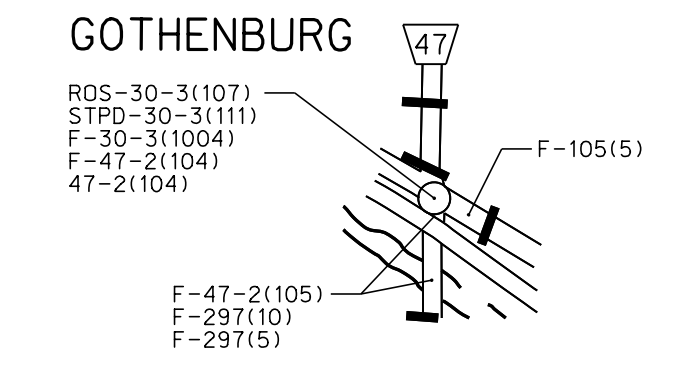
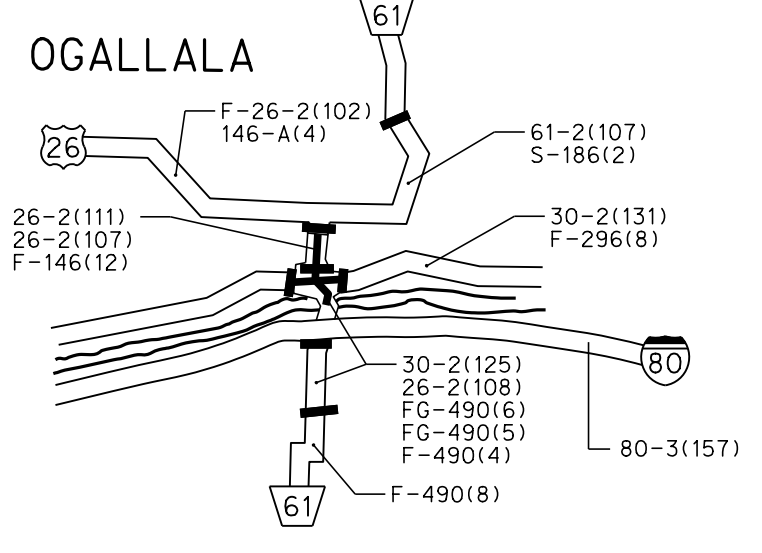
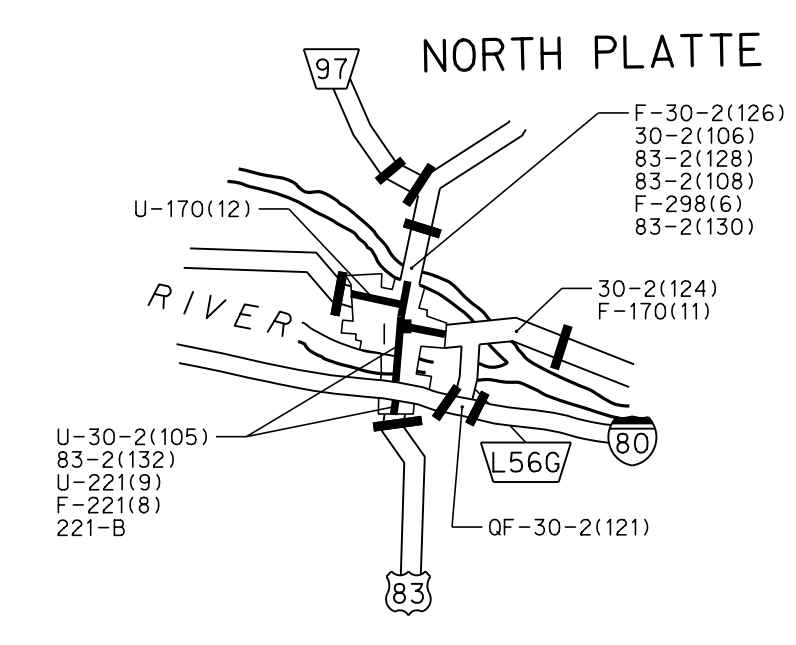
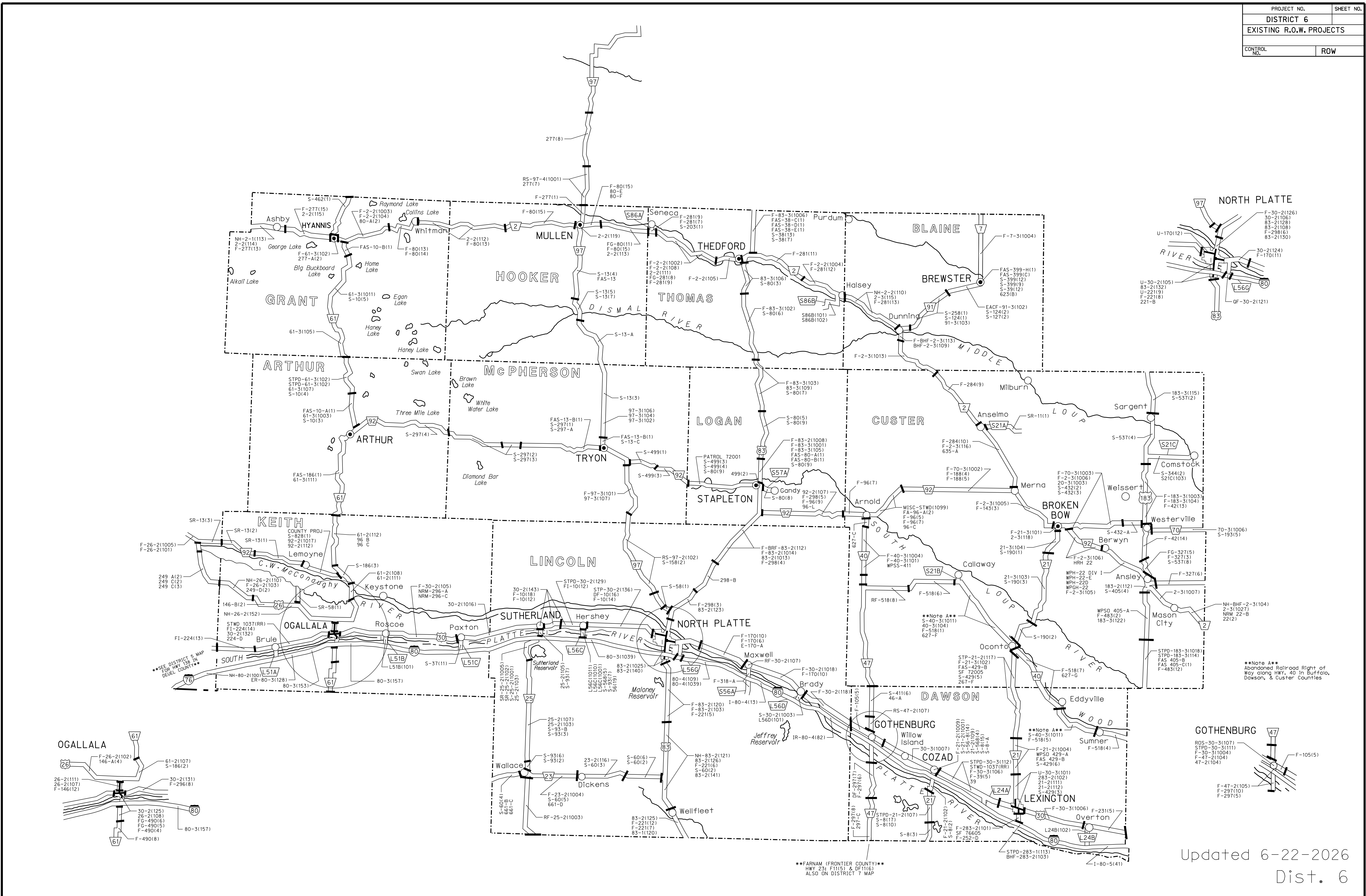

FARNAM (FRONTIER COUNTY)
 HWY 23: F11(5) & DF1(6)
 ALSO ON DISTRICT 7 MAP

Updated 6-22-2026
 Dist. 6

PROJECT NO.	SHEET NO.
DISTRICT 7	
EXISTING R.O.W. PROJECTS	
CONTROL NO.	ROW
Updated 6-23-2026	

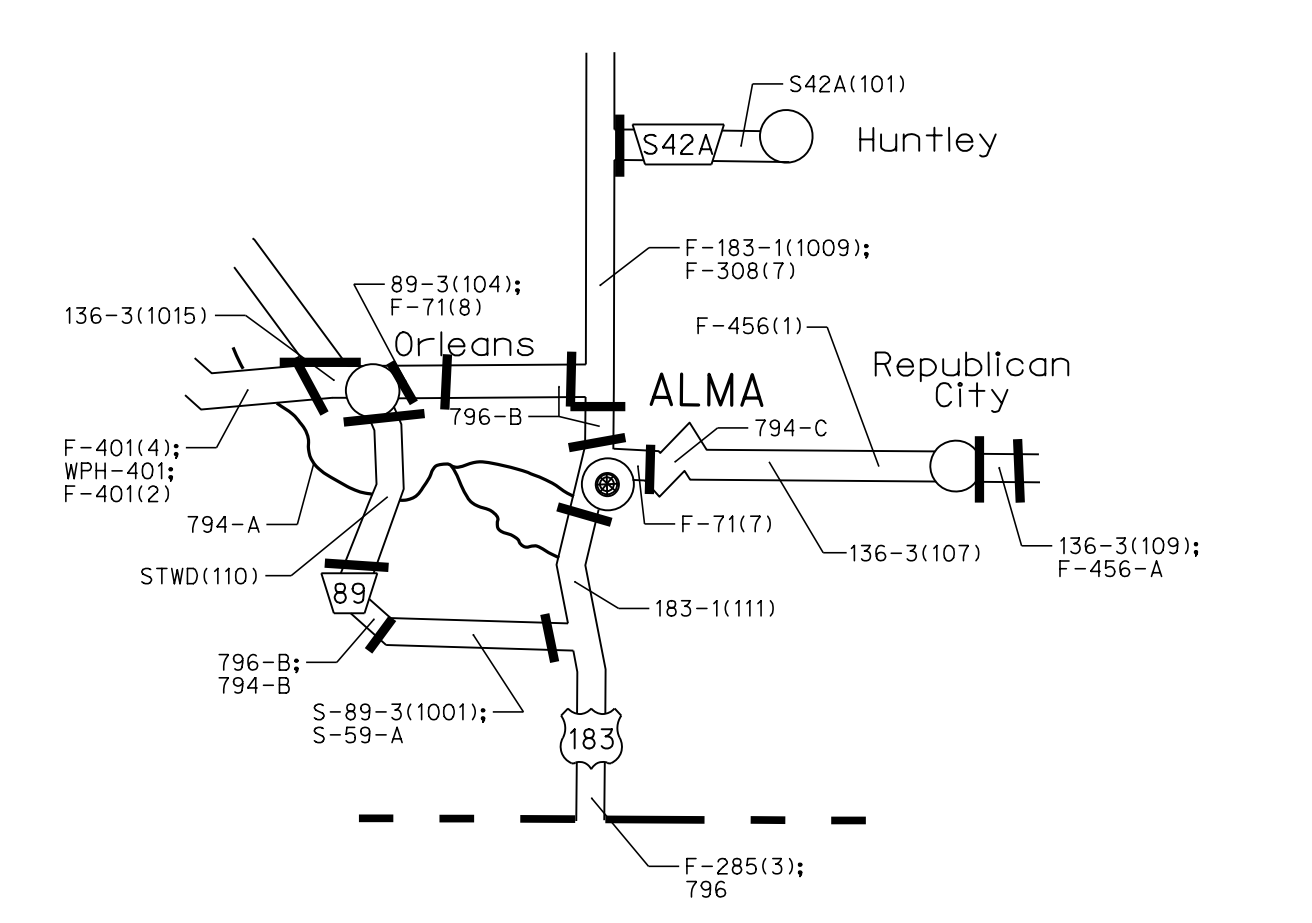
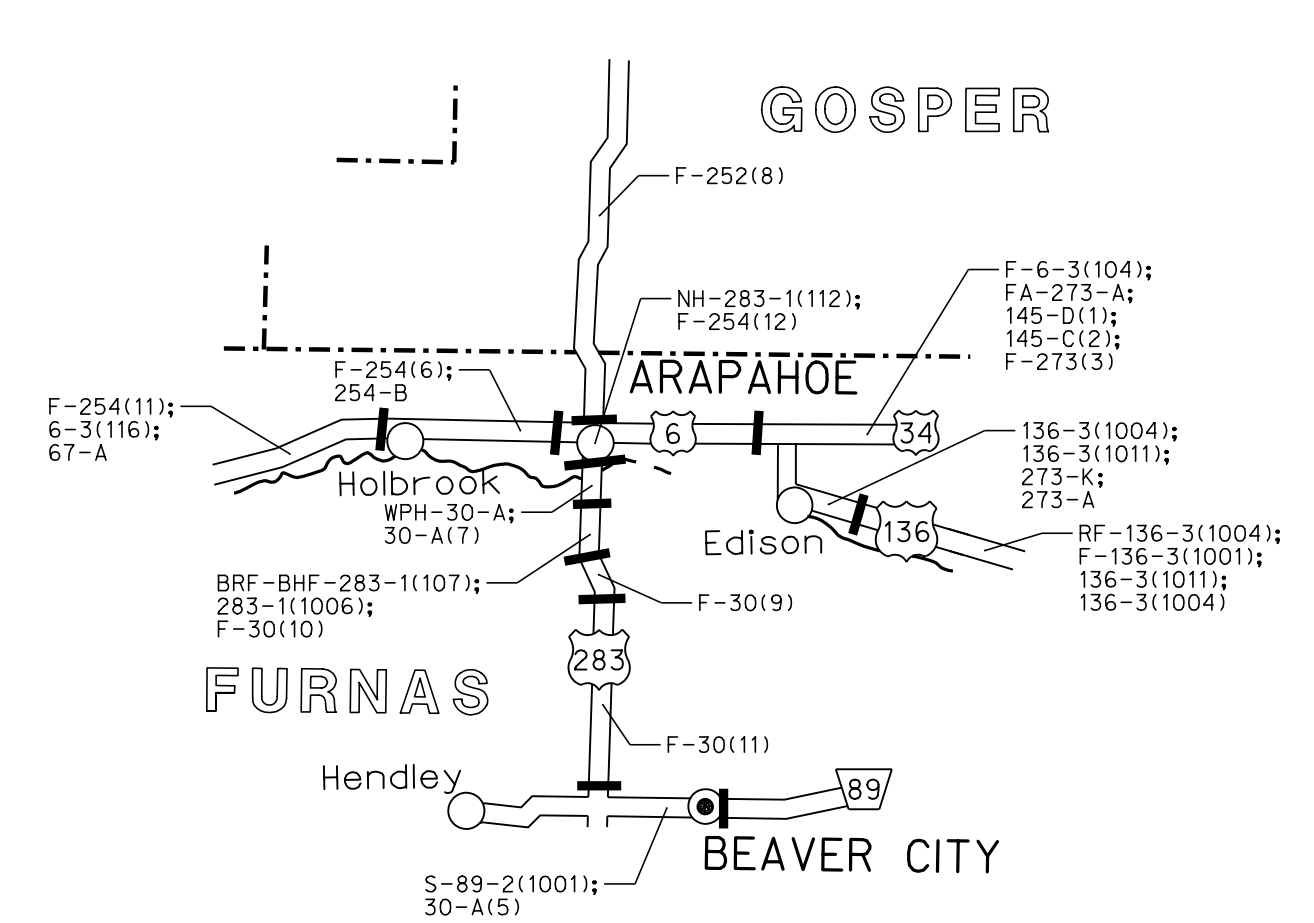
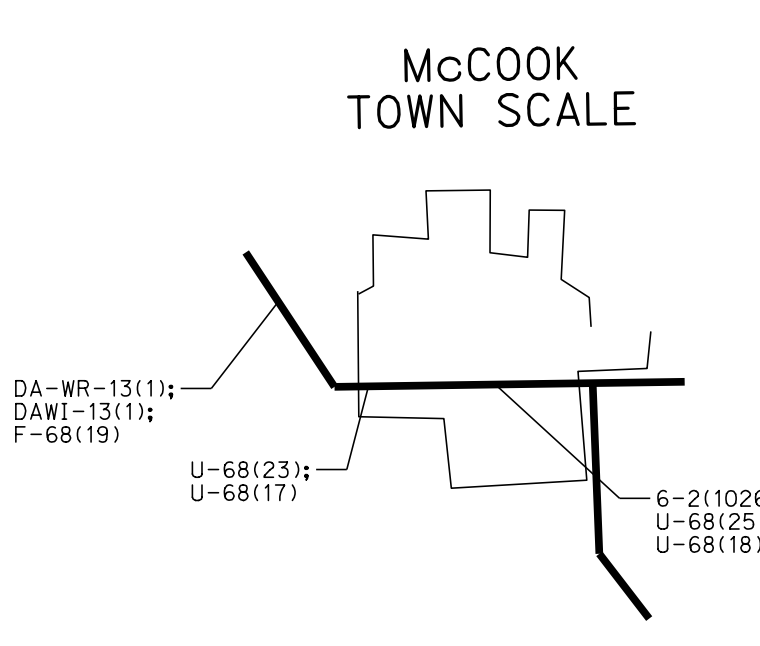
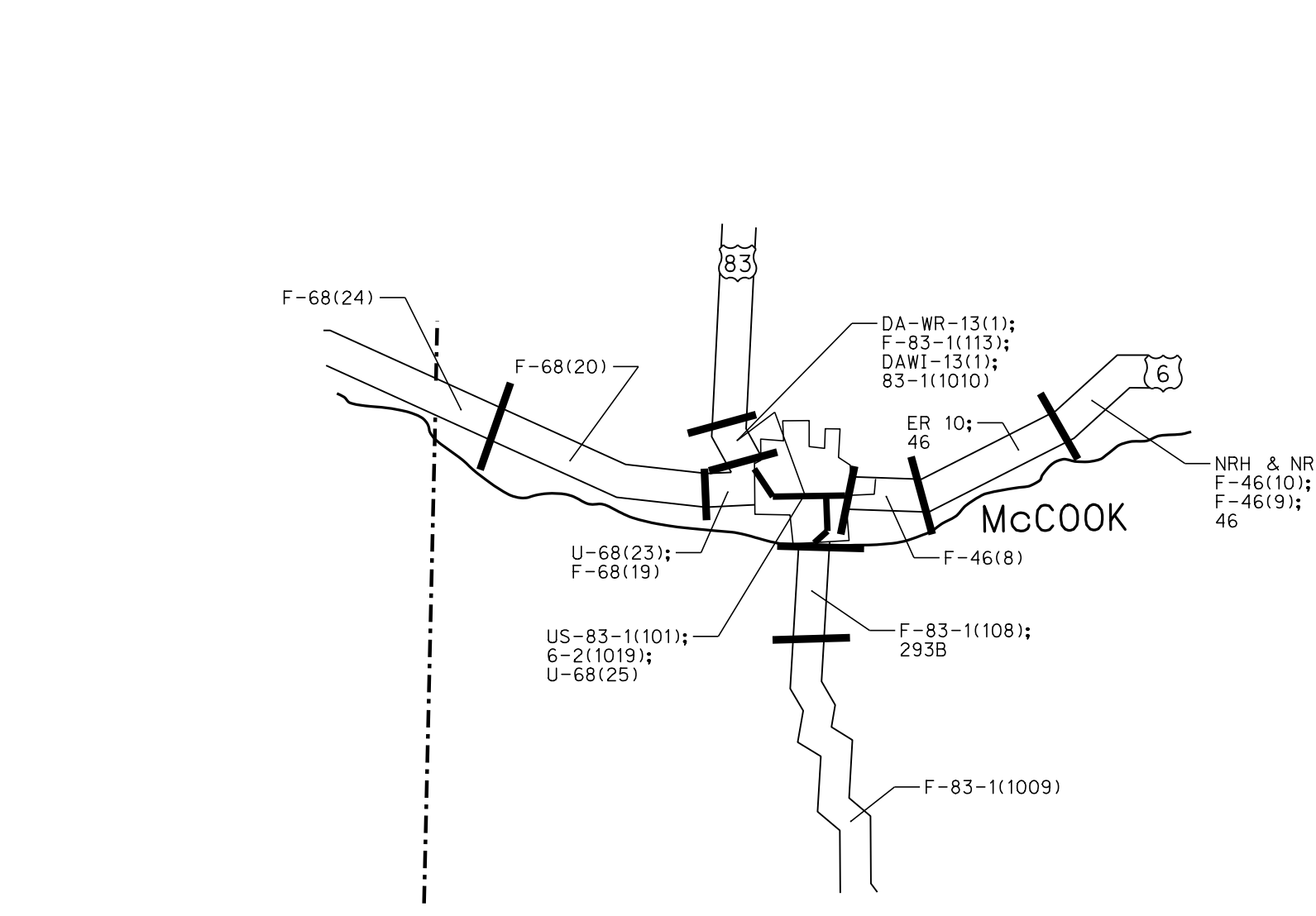
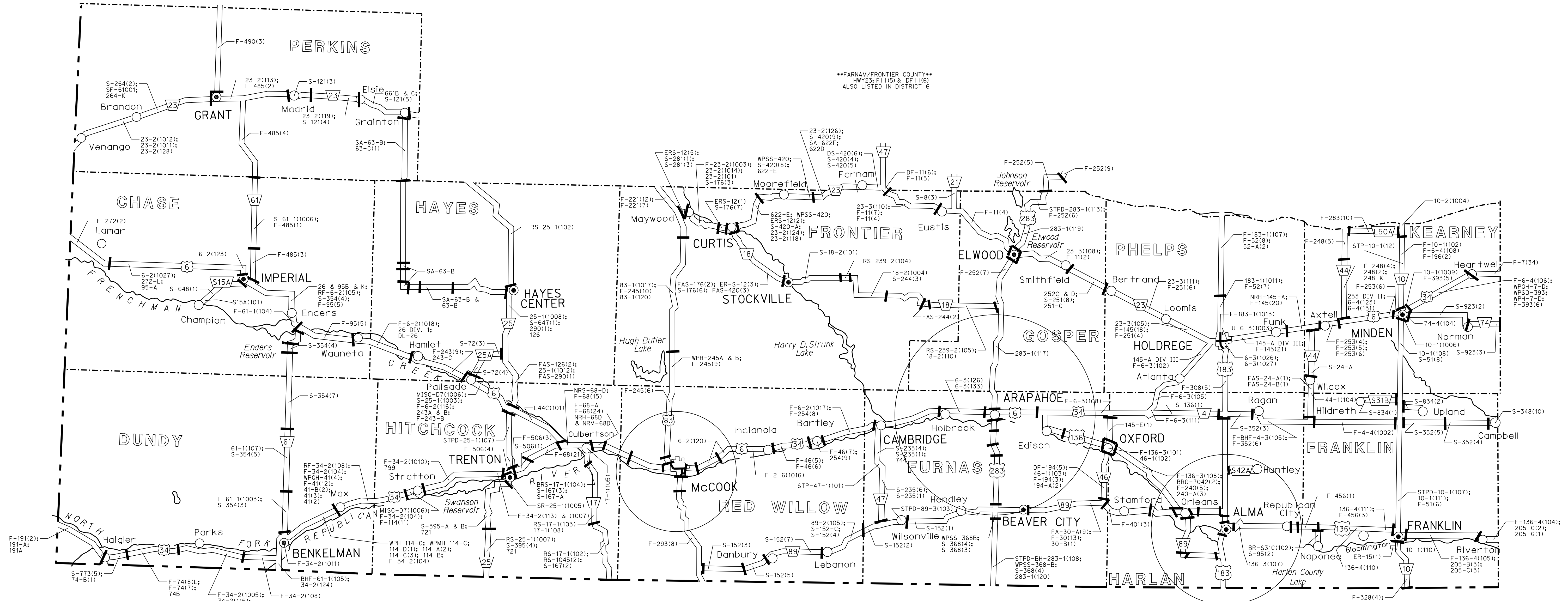

PROJECT NO.	SHEET NO.
DISTRICT #8	
EXISTING R.O.W. PROJECTS	
CONTROL NO.	ROW

Updated 6-22-2026

