

Chapter Four presents guidance for the design of New and Reconstructed projects; design guidance for 3R projects is provided in Chapter Seventeen.

Chapter Four

Intersections, Driveways and Channelization

1. INTERSECTIONS

Intersections are locations where two or more roadways or entrances cross and/ or meet each other at the same elevation. The design of an intersection will affect the operation and capacity of the approach roadways.

Intersection design should consider driver expectancy, vehicle operating characteristics, and the intersection environment. Intersection design elements should be standardized as much as possible to avoid presenting unexpected or confusing situations to roadway users. The intent of intersection design should be the efficient movement of vehicles through intersections by the proper use and placement of design elements.

The environment of an intersection includes:

- The surrounding land use and zoning
- Traffic composition
- Traffic flows
- Non-motorized usage
- Traffic control
- Provisions for parking
- Public transit
- Signing
- Utilities
- Lighting
- Traffic barriers
- Roadway surface conditions

For a detailed discussion of intersection/ driveway design see Chapter 4, Section 4.15.2 and Chapter 9, Section 9.11.6 of A Policy on Geometric Design of Highways and Streets (the *Green Book*) (Ref. 4.1), the **Federal Highway Administration's (FHWA's) Manual on Uniform Traffic Control Devices (MUTCD)** (Ref. 4.2) (<http://www.roads.nebraska.gov/business-center/contractor/mutcd/>), the State of Nebraska Supplement to the Manual on Uniform Traffic Control Devices (NE-MUTCD) (Ref. 4.3) (<http://www.roads.nebraska.gov/business-center/contractor/mutcd/>), and NCHRP Report 420, Impacts of Access Management Techniques (Ref. 4.5).

1.A Types Of Intersections

Intersections are usually either a three-leg or a four-leg design (See the *Green Book*, Ref. 4.1, FIGURES 9-5 through 9-10). Both three-leg and four-leg intersections may vary in size, shape, and channelization.

Intersections having five or more legs should be avoided. Measures to reduce vehicle collisions and improve the efficiency at these intersections include:

- Realignment of one or more of the intersecting legs
- Combining some of the traffic movements at adjacent intersections
- Making some legs one-way with the traffic direction away from the intersection
- Construct a roundabout

Many factors enter into the selection of intersection type, but the principal controls are:

- Design vehicle
- Design hour traffic volumes (DHV)
- Composition of traffic
- Design speed
- Type of traffic control
- Proximity of accesses

See Section 1.E of this chapter for additional information.

1.A.1 Unchannelized Intersections

The most common type of intersection is the unchannelized, consisting of the crossing of two roadways at the same elevation connected by radius returns to accommodate the wheel paths of turning vehicles. Typical characteristics of unchannelized intersections are low turning movements and low overall traffic volumes.

1.A.2 Channelized Intersections

Channelized intersections separate conflicting traffic movements into definite paths of travel by the use of pavement markings and/ or curbs. A primary purpose of channelization is to provide reference points to enable a driver to predict the path of intersecting vehicles. Channelization also serves to segregate, store, and protect turning and crossing vehicles. Median and island channelization also provides a location for the installation of traffic control devices. See Section 5 of this chapter for further discussion of channelization.

1.A.3 Roundabouts

Roundabouts are circular intersections in which the traffic flows around a central island. Entry and exit to/ from a roundabout is accomplished through a low speed right turn, yielding to the traffic already in the roundabout, which substantially reduces the number, type, and severity of traffic accidents in the intersection (See [EXHIBIT 4.1](#) and **FIGURES 9-12, 9-13, 9-14, 9-61, and 9-62** of the *Green Book*, Ref. 4.1).

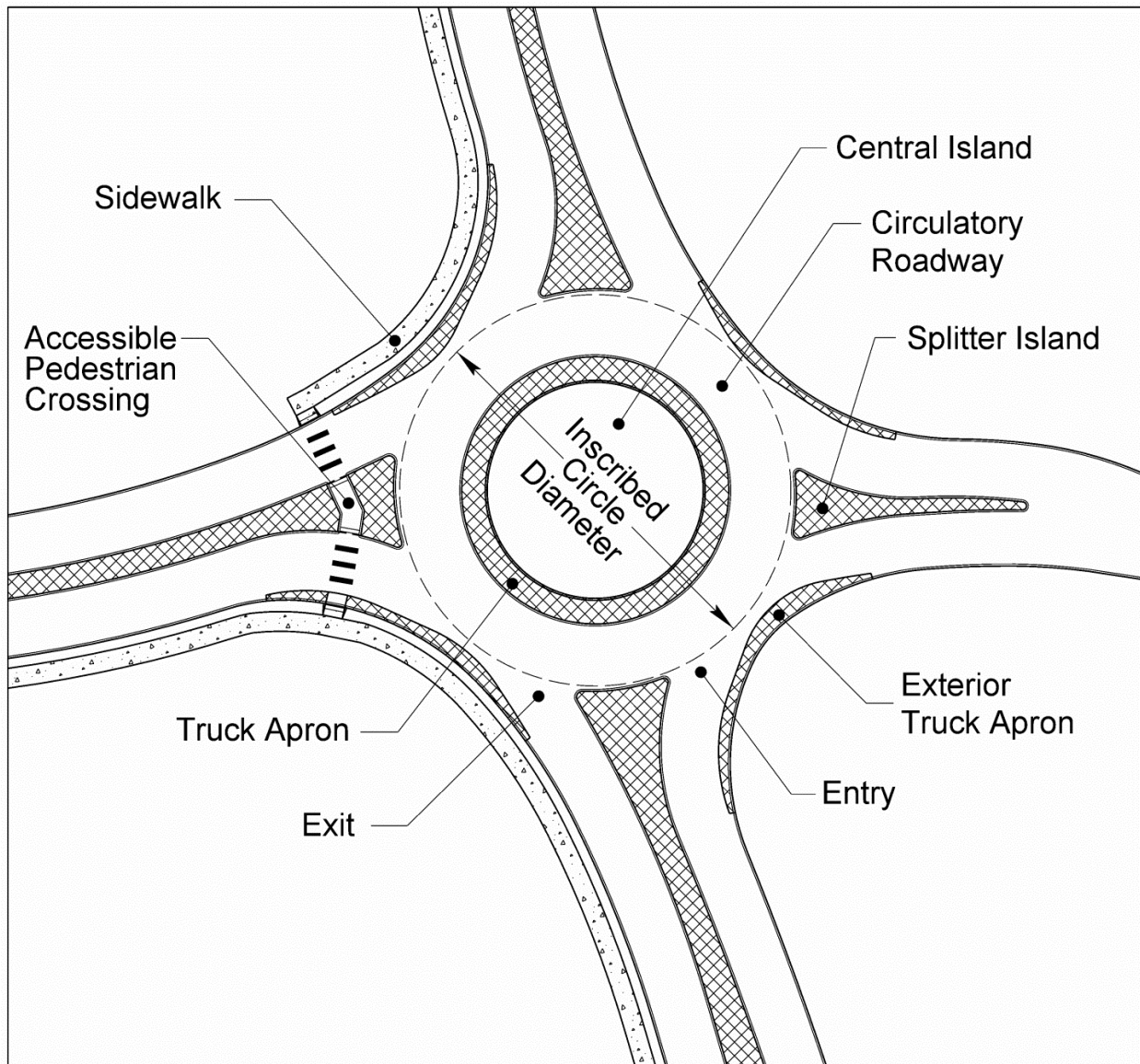
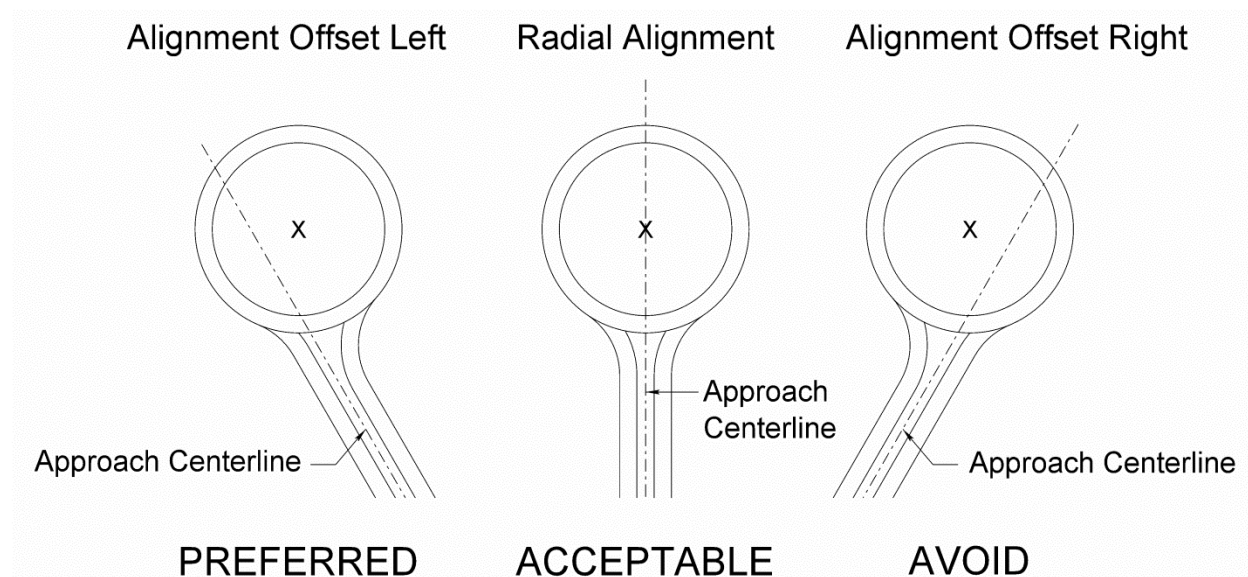

Exhibit 4.1 Typical Elements of a Roundabout Intersection

The Nebraska Department of Transportation (NDOT) will use the roundabout design guidance found in Chapter 6 of NCHRP Report 672, "Roundabouts: An Informational Guide", Second Edition (Ref. 4.18) (http://onlinepubs.trb.org/onlinepubs/nchrp/nchrp_rpt_672.pdf). Additional NDOT guidance includes:

- **Design Vehicle:**
 1. The design vehicle for the intersection of all State Highways, rural and urban, will be the WB-67
 2. The design vehicle for urban roundabouts which do not involve a state highway will be based on the traffic composition
- **Assumed Running Speed within 400 feet of the Intersection:** 45 mph (See "Appropriate Design Speed for Horizontal Curves Approaching a Stop", Ref. 4.4)
- **Lanes:** The **Traffic Engineering Division (Traffic Engineering)** will recommend the number of lanes for the roundabout, including any auxiliary or by-pass lanes.
- **Alignment:**



- **Vertical Approach Grade:** +2% entering the roundabout (at the edge of the inscribed circular roadway) and for approximately $\frac{1}{2}$ the length of the entry radius
- **Splitter Island:**
 1. **Splitter Island Length:** 200 feet minimum for rural high-speed roadways, 50 feet minimum for urban roadways
 2. **Roadway Taper Rate Approaching the Splitter Island:** 50:1 for rural high-speed roadways (design speed \geq 50 mph); the taper rate should equal the posted speed limit (at a minimum) for low-speed (design speed \leq 45 mph) roadways
 3. **Approach Roadway Width at the Splitter Island:** 16 feet to 18 feet back-of-curb to back-of curb
- **Splitter Island and Truck Apron:** Both the splitter island and the truck apron shall be textured and a different color than the pavement; exterior truck aprons will be flush with the adjacent lane

- **Curbs:**
 1. Beyond 400 feet of the inscribed circle, a 4-inch sloping curb will be used for the outer curb and for any medians
 2. Within 400 feet of the inscribed circle, a 6-inch integral curb will be used for the outer curb and for the splitter island (splitter islands on roundabouts **must** be raised)
 3. A 3-inch sloping truck apron curb will be used for the outer radius of the center island truck apron (See [EXHIBIT 4.2](#))
 4. When required (the central island slopes towards the truck apron) a 4-inch sloping curb will be used for the inner radius of the center island truck apron (See [EXHIBIT 4.2](#))
- **Curb Clearance:** A 3-foot minimum clear distance will be maintained between the outside tire edge of the design vehicle wheel path and the back of the outer curb
- **Curb Inlet Location:** Avoid placing in the right-turn path of a truck
- **Drives:** In rare instances when a driveway must have direct access onto or near the roundabout it will look like a driveway (e.g. appropriate drive radius, use of a 2-inch slope curb). All access, both on and near the roundabout, will be coordinated with **Traffic Engineering**
- **Lighting:** Lighting will be required on roundabouts

For additional information see Section 9.3.4, “Roundabouts” and Section 9.10, “Roundabout Design” in Chapter 9 of the *Green Book* (Ref. 4.1), [NCHRP Report 672](#) (Ref. 4.18), and Chapter Ten: [Miscellaneous Design Issues](#), Section 4.B.

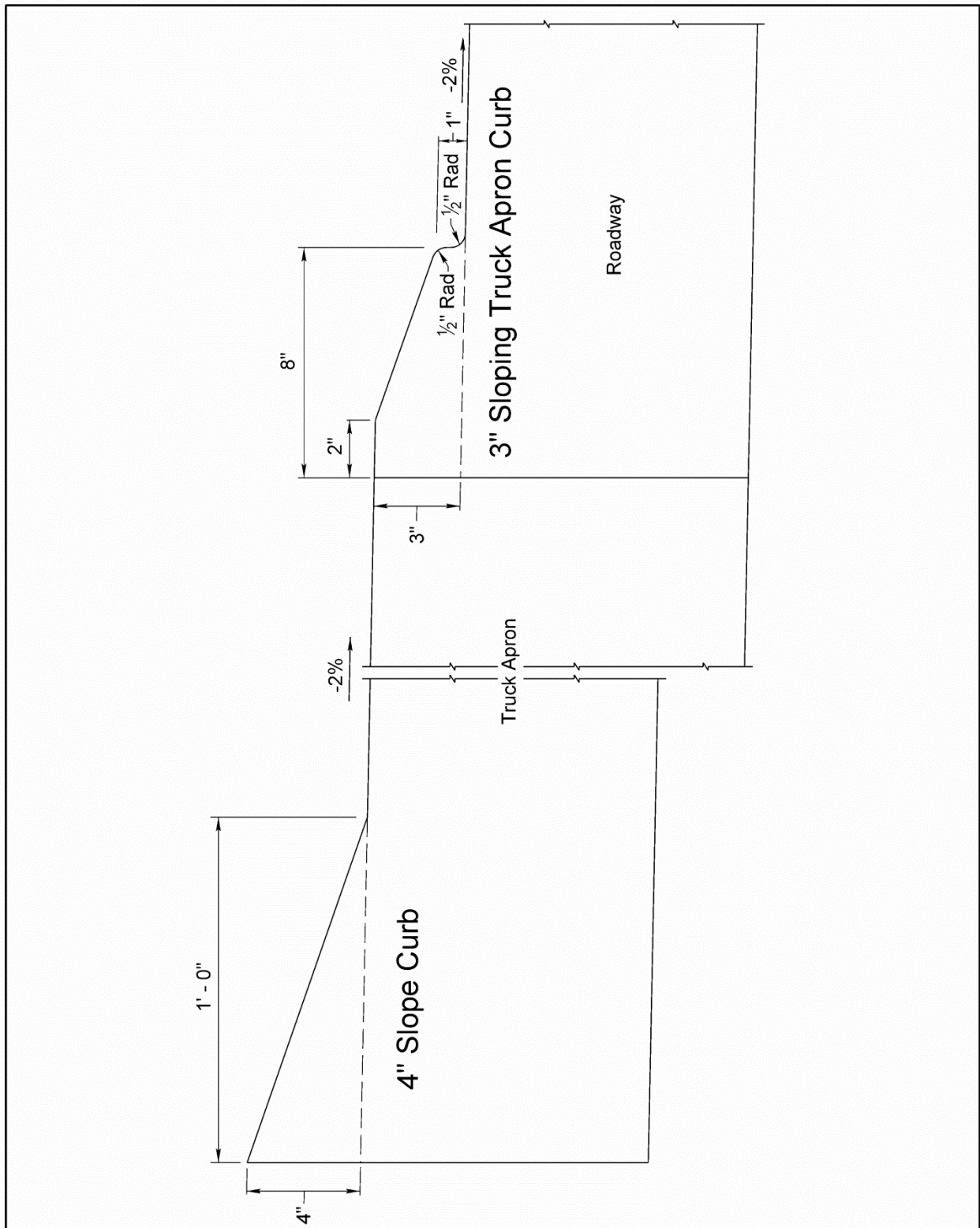

Exhibit 4.2 Roundabout Intersection – Typical Truck Apron Curb Arrangement

1.B Intersection Locations

1.B.1 The Intersection of Two State Highways

The design of an intersection of two state highways requires coordination and input from the roadway designer, **District**, and **Traffic Engineering**. This team will address aspects of the intersection as they relate to each other, including but not limited to:

- The crash history
- The horizontal and vertical alignments
- Intersection drainage
- Signage
- Driver expectation
- Driver perception
- Approach visibility
- Proximity of access

The designer will alert **Traffic Engineering** of any changes to the intersection environment (the existing conditions and/ or any changes throughout the design process). EXHIBIT 4.3 shows design guidance for the intersection geometry.

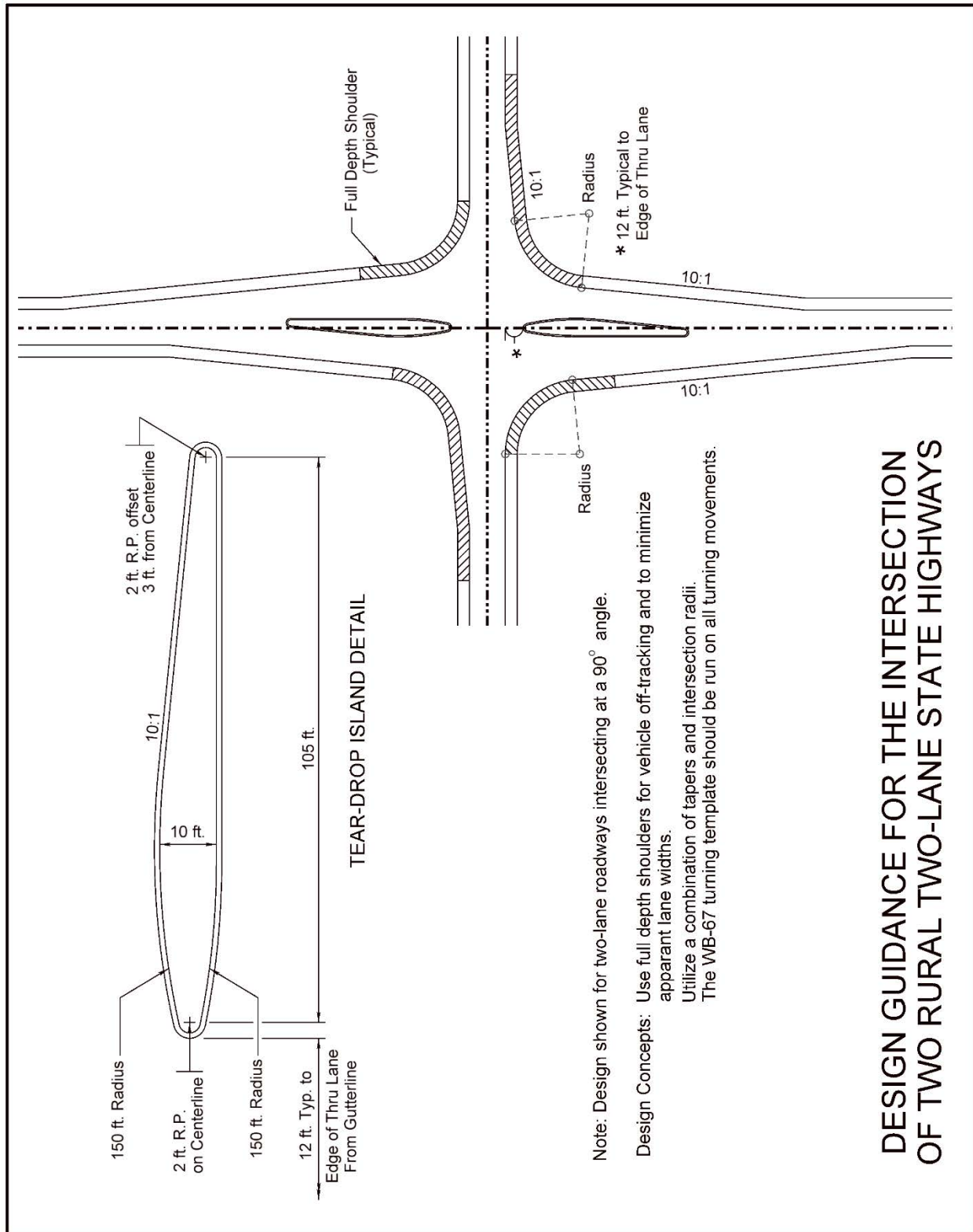

Exhibit 4.3 Design Guidance for the Intersection of Two Rural Two-Lane State Highways

1.B.2 Rural Intersections

A rural intersection often consists of the crossing of a low volume roadway with a higher type roadway. The low volume roadway may carry agricultural equipment or other slow-moving, heavily laden vehicles across or onto the main roadway.

Topography plays a major role in the design of a rural intersection. The placement of an intersection within a length of roadway where the driver's sight distance is impaired should be avoided. If indicated by the crash history, the vertical and/ or horizontal alignment should be investigated for the potential of increasing the intersection sight distance (See Section 1.C.2 of this chapter). When the location of an intersection is on a horizontal or vertical curve, **Traffic Engineering** may be consulted regarding the need to add auxiliary lanes to separate the through traffic from the turning traffic.

1.B.3 Urban Intersections

Due to existing development, there is limited opportunity for new intersection locations in urban areas; therefore, the design of most urban intersections must be coordinated with and tied to the geometry of the existing roadway system. Grades, lane widths, and intersection return radii should match those already present when no other options are available.

Urban intersection operation may be affected by:

- Traffic composition
- Significant directional traffic flow during peak periods
- Intersection spacing
- Adjacent intersection operation
- Mid-block traffic generators
- Pedestrian and/ or bicycle traffic
- On-street parking

Sight distance at urban intersections may be obstructed by:

- The vehicle stop-line setback for pedestrian crosswalks
- Trees
- Fencing
- Signing
- Traffic signal control boxes
- Other development

The design of urban intersection improvements should include field surveys to ascertain whether the desired intersection sight distance either currently exists or can be achieved (See Section 1.C.2 of this chapter).

1.B.4 Frontage Roads

The use of frontage roads allows the traffic capacity on the main roadway to remain at a higher level of service by combining driveway and/ or minor roadway access locations into one intersection with the main roadway. In areas experiencing a transition from rural to urban character or from agricultural to commercial use, designers should anticipate possible future congestion and consider the addition of frontage roads.

Frontage roads can be designed to accommodate parking, transit services, and bicycle traffic for a developed corridor. The flow chart in EXHIBIT 4.4 should be used to determine the roadway widths of frontage and access roads. EXHIBIT 4.5 shows a typical frontage road connection off of a major roadway.

If the frontage road intersects with a crossroad, the edge of the pavement of the frontage road should be a minimum distance of 220 feet from the edge of the through driving lane of the main roadway to provide sufficient distance for the development of left-turn lanes and for signing (See EXHIBIT 4.6). **Traffic Engineering** should be consulted to determine the actual distance required and to determine if traffic signals are warranted at the frontage road intersection based on the traffic volumes.

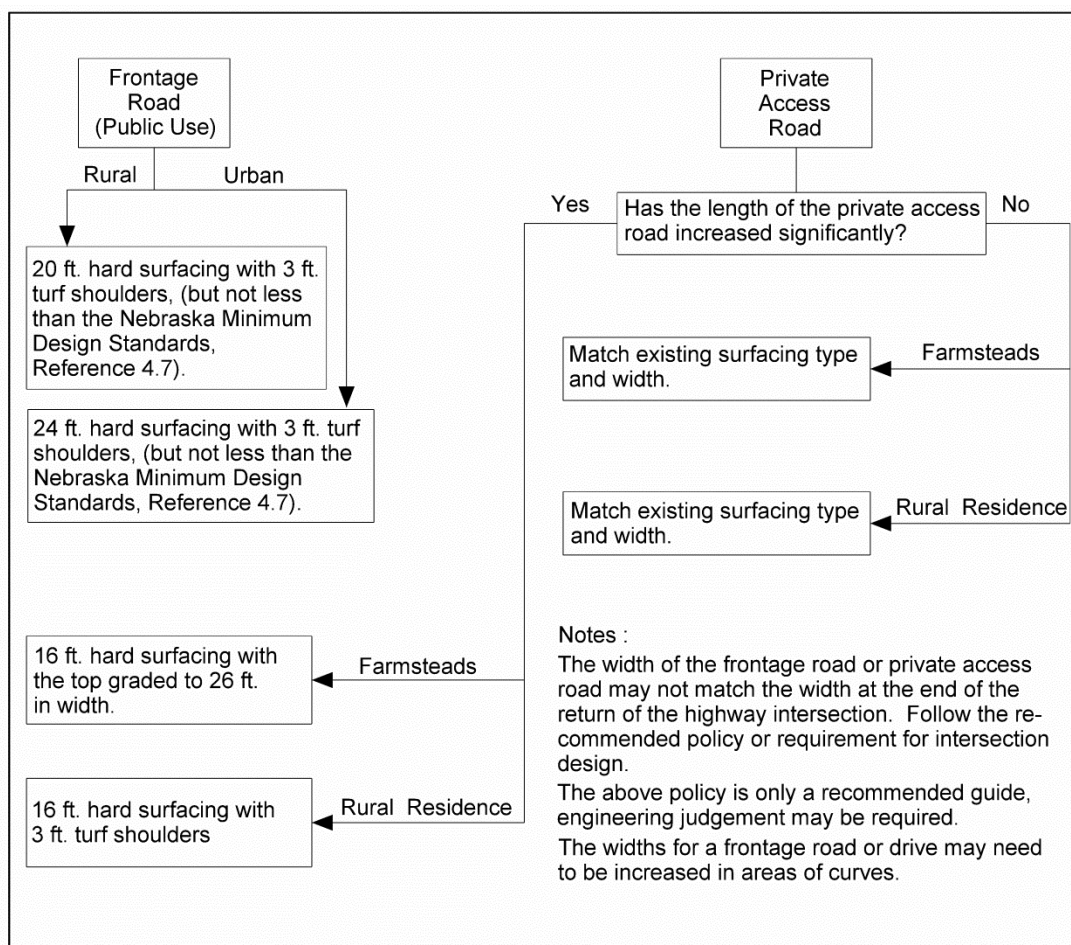

Exhibit 4.4 Flow Chart for Roadway Widths of Frontage Roads and Access Roads

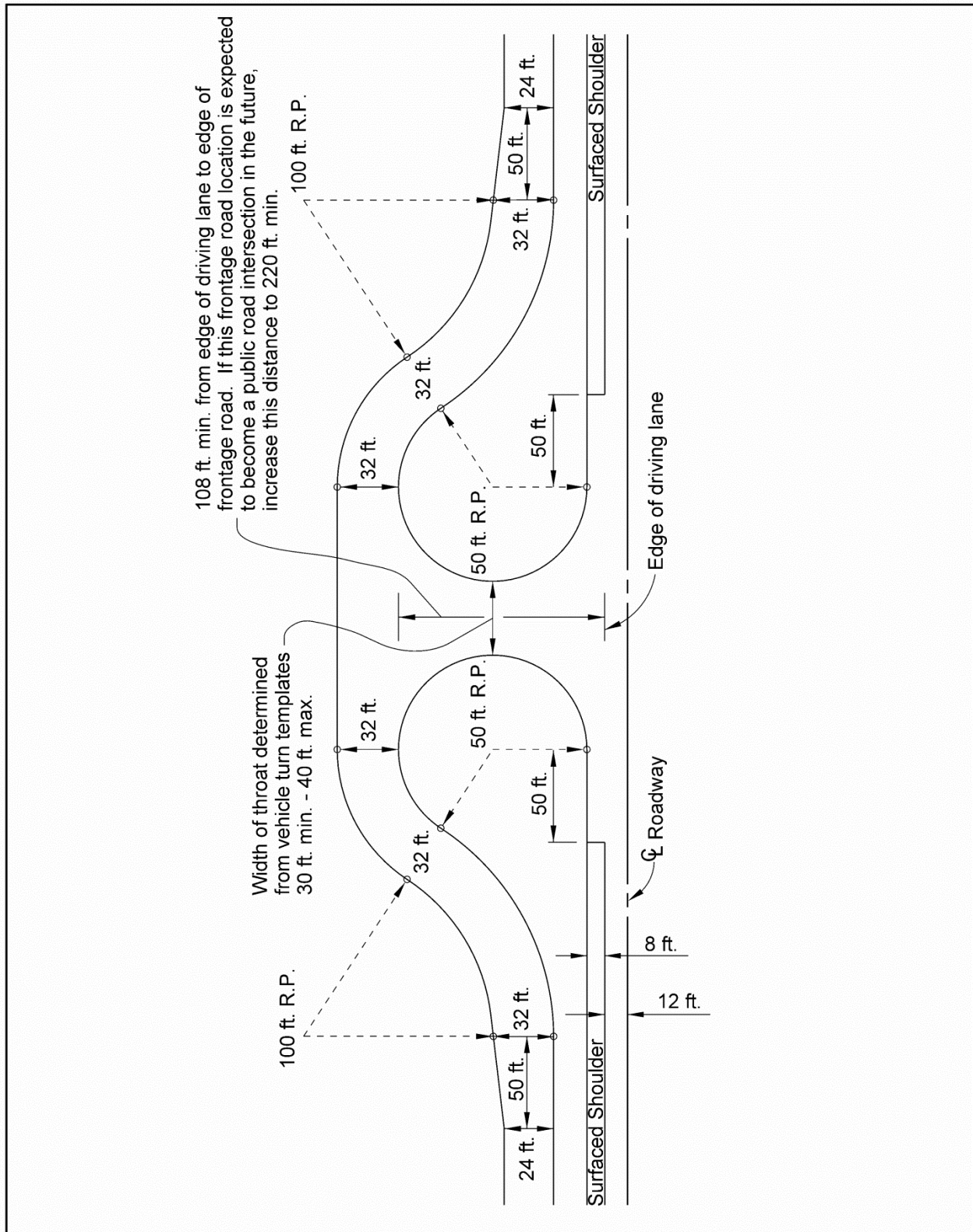

Exhibit 4.5 Typical Frontage Road Connection off of a Main Roadway

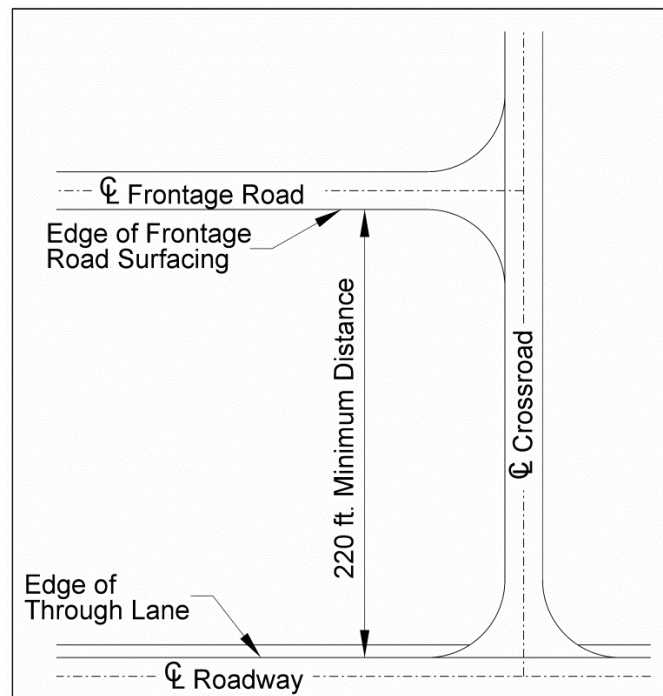

Exhibit 4.6 Typical Frontage Road Connection off of a Crossroad

1.C Intersection Design Considerations

1.C.1 Capacity and Level of Service

The capacity of an intersection and the performance of the traffic flow passing through it vary considerably depending on the traffic controls used. Capacity analysis and the design of the intersection geometry should go hand-in-hand. **Traffic Engineering** performs capacity analysis with input from **Roadway Design**; **Roadway Design** in turn utilizes the capacity analysis results for the design of the intersection geometry.

1.C.2 Intersection Sight Distance

Intersection sight distance consists of the provision of sight triangles along each leg of an intersection which are free of visual obstacles, giving a driver sufficient time and distance to avoid conflicts at the intersection (See **FIGURE 9-16** of the *Green Book*, Ref. 4.1). For New and Reconstructed projects, the minimum stopping sight distance shall be provided on each leg of an intersection consistent with its design speed; intersection sight distance should be provided at unsignalized intersections (See Chapter Three: Roadway Alignment, EXHIBITS 3.9 & 3.14, of this manual for desirable sight distances).

The location of each intersection should be reviewed to identify sight restrictions. Intersections on New and Reconstructed projects should be designed for intersection sight distance for left-turns from a major roadway based on a passenger car (Case F from Section 9.5.3, "Intersection Control" in Chapter 9 of the *Green Book*, Ref. 4.1); **Assistant Design Engineer (ADE)** approval is required if this condition cannot be met. For additional information see So You Want Access to the Highway? (Ref. 4.17) (<http://www.roads.nebraska.gov/media/3462/access-hwy.pdf>).

1.C.3 Horizontal Alignment

Desirably, all legs of an intersection will be on a tangent alignment; when roadways intersect on a horizontal curve, the design of the intersection geometry becomes significantly more complicated. Horizontal alignment at intersections requires special consideration of intersection sight distance, crash history, superelevation development, and other related factors. See Chapter Three: Roadway Alignment, Section 2, of this manual for additional information.

1.C.3.a Intersection Skew w/ Stop Control on Minor Roadway

Roadways should intersect at approximately 90°. A right angle intersection provides a driver with the best conditions for judging the lane orientation and speed of vehicles on other approaches, provides a minimum distance for vehicles crossing through the intersection, and equalizes the turning maneuvers in all four quadrants.

The intersection skew angle is defined as the degree of deviation from 90° (EXHIBIT 4.7). When designing New and Reconstructed projects, a skew of 15° or less is preferred. Use of a skew angle greater than 15° requires **Unit Head** approval, with input from **Traffic Engineering**. The allowable skew for 3R projects will be based on the recommendations from **Traffic Engineering** and on the crash history of the intersection.

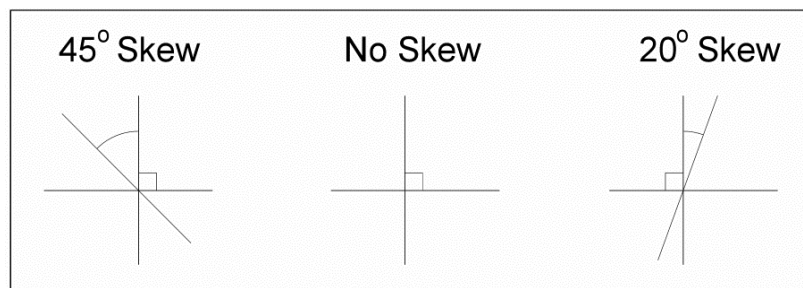
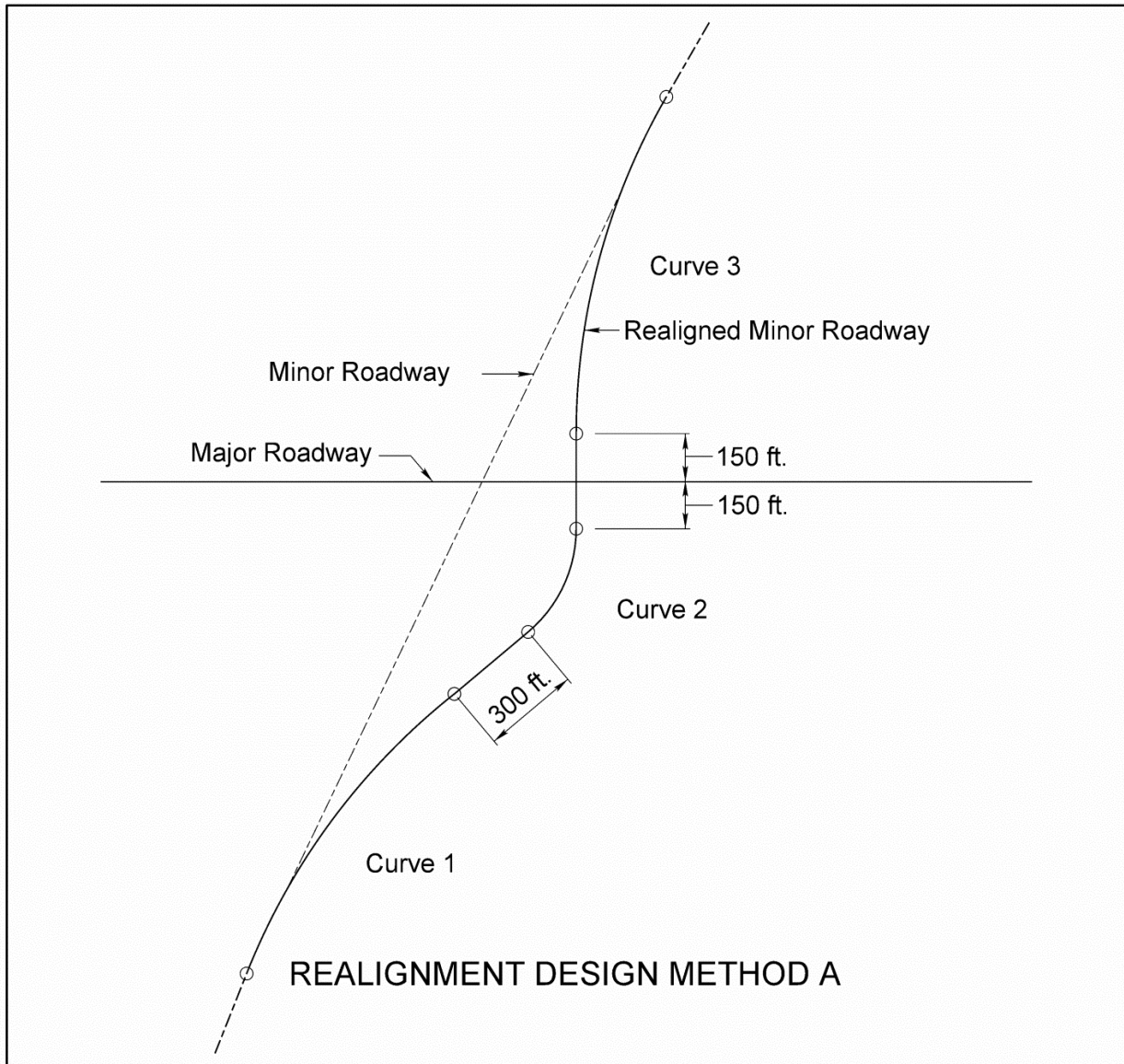

Exhibit 4.7 Skew Angle Definition

Method A (See EXHIBIT 4.8) is used when there are excessive impacts on one side of the roadway (e.g. wetlands, buildings, grain elevators), Method B is the preferred intersection realignment; Methods C and D should only be used under very low volume conditions or, if in urban areas, where a minimum distance is provided between the offset intersections (**Traffic Engineering** may analyze the intersection configuration for left turn conflicts, etc. and will determine the minimum required distance). The dimensions and curve values given in EXHIBIT 4.8 are suggested design values only. The final design of the realignment requires **Roadway Design Unit Head (Unit Head)** approval.

At intersection locations where the topography or where right-of-way impacts constrain intersection realignment, the designer should investigate the feasibility of realigning the intersection to the extent practicable.



Intersection Skew Angle	Curve 1			Curve 2			Curve 3		
	Radius Feet	Deflection Angle Δ	Curve Length Feet	Radius Feet	Deflection Angle Δ	Curve Length Feet	Radius Feet	Deflection Angle Δ	Curve Length Feet
20°	1910	20°	667	382	40°	267	1910	20°	667
30°	1910	30°	1000	382	60°	400	1910	30°	1000
45°	1910	45°	1500	382	90°	600	1910	45°	1500

Note: Dimensions and curve values shown above are suggested design values. The final design of the realignment requires **Unit Head** approval.

Exhibit 4.8a Intersection Realignment Design Method A

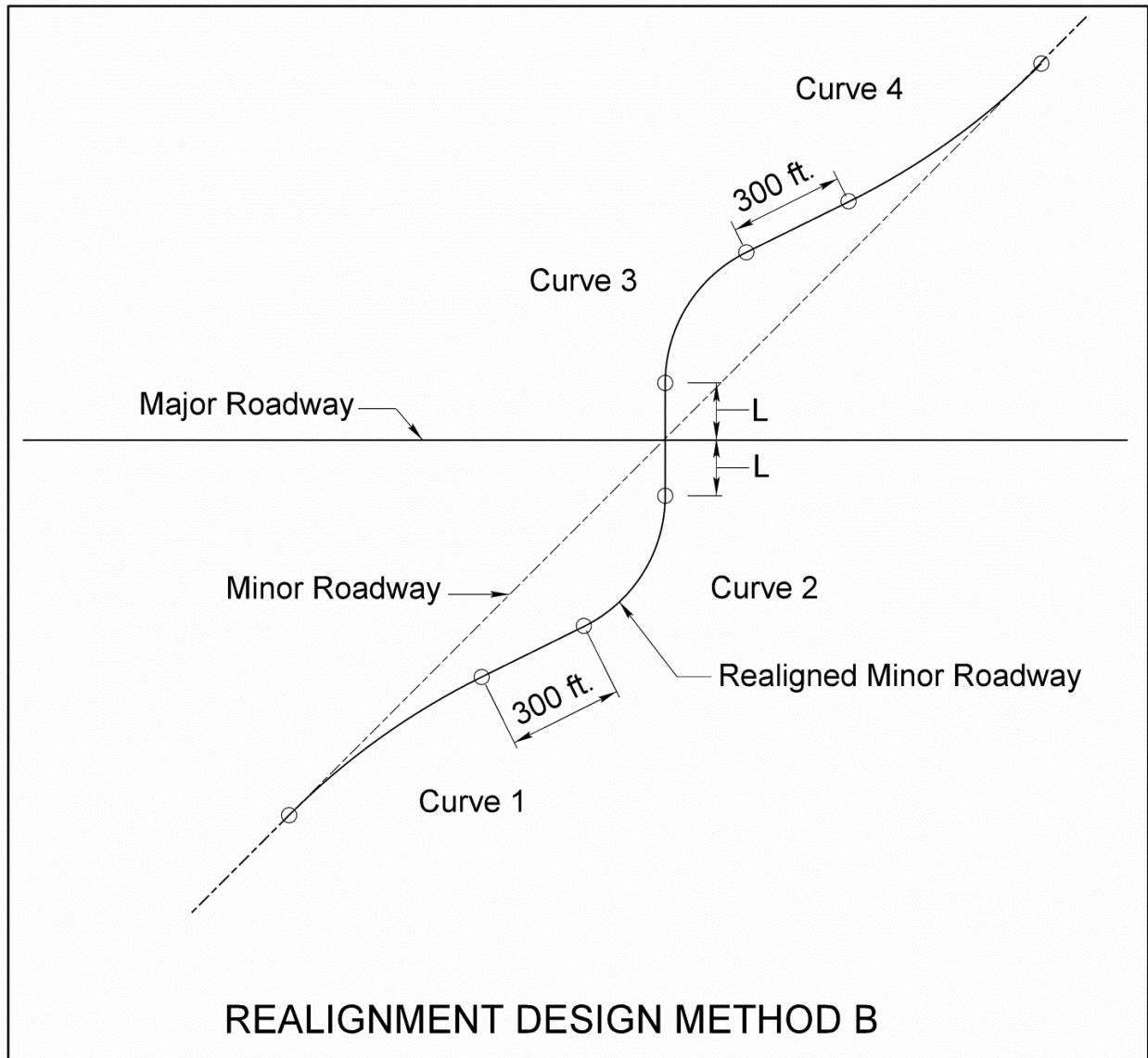

Intersection Skew Angle	L Feet	Curves 1 and 4			Curves 2 and 3		
		Radius Feet	Deflection Angle Δ	Curve Length Feet	Radius Feet	Deflection Angle Δ	Curve Length Feet
20°	150	1910	9°	300	382	29°	193
30°	150	1910	13°	433	382	43°	287
45°	150	1910	18.75°	625	382	63.75°	425
60°	155	1910	24.25°	808	382	84.25°	562

Note: Dimensions and curve values shown above are suggested design values. The final design of the realignment requires **Unit Head** approval.

Exhibit 4.8b Intersection Realignment Design Method B

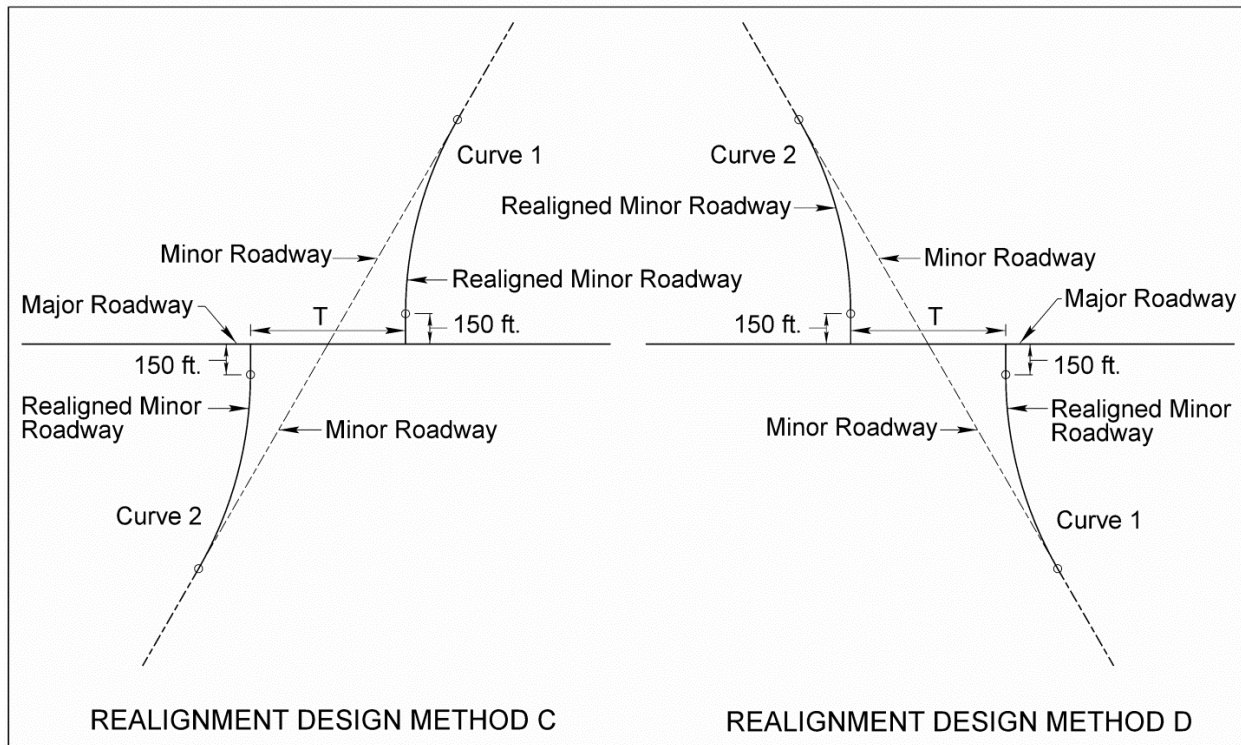

Intersection Skew Angle	T Feet	Curve 1			Curve 2		
		Radius Feet	Deflection Angle Δ	Curve Length Feet	Radius Feet	Deflection Angle Δ	Curve Length Feet
20°	354	1910	20°	667	1910	20°	667
30°	764	1910	30°	1000	1910	30°	1000
45°	1882	1910	45°	1500	1910	45°	1500
60°	4339	1910	60°	2000	1910	60°	2000

Note: Dimensions and curve values shown above are suggested design values. The final design of the realignment requires **Unit Head** approval.

**Exhibit 4.8c Intersection Realignment Design
 Methods C and D**

1.C.3.b Intersections on Curved Alignments

When a minor roadway intersects a mainline roadway which is on a horizontal curve, the minor roadway should be realigned to provide as close to a 90° intersection to the local tangent of the mainline curve as possible. Intersection sight distance should be investigated if the curve of the roadway may cause an unacceptable line of sight or cause the driver to have to look too far back over his/ her shoulder (especially the right shoulder) to see oncoming traffic.

An intersection on a curved roadway alignment requires additional design consideration. The superelevation rate for state highways at intersections with other public roads is desirably 4% or less.

Research by the University of Nebraska, “Appropriate Design Speed for Horizontal Curves Approaching a Stop” (Ref. 4.4), shows that the running speed on a curve approaching a stop sign decreases to 45 mph at approximately 400 feet from the stop sign. The superelevation of stop-controlled approaches on curved alignments within this distance should be transitioned from the full superelevation at the PC to the superelevation at the PT (based on the appropriate speed and curve radius) throughout the remainder of the curve to allow vehicles to retain control during slowing and stopping. A short tangent section should be provided on the approach to the intersection. For further information regarding horizontal alignment, see Chapter Three: Roadway Alignment, Section 2, of this manual. For further discussion of intersection realignment, see the “Guidelines for Realignment of Skewed Intersections” (Ref. 4.8).

1.C.4 Profile

The profile gradient through an intersection must reflect the practicalities of matching the basic profiles of the intersecting roadways. The gradients of intersecting highways should be as flat as possible, with a consistent gradient through the intersection to facilitate traffic turning movements and to minimize the chance of stopping vehicles from sliding onto the mainline roadway when the pavement is wet or icy.

Appreciable changes in the design roadway elevation at intersections with existing cross roads and driveways should take into consideration the extent of reconstruction that will be required along the cross road or driveway to match the elevation of the new alignment profile. A profile that results in excessive grades for side roads and driveways is not a desirable design. Adjustment to the profile of an existing cross road will meet either the published standards of the appropriate city/ county or the Nebraska Minimum Design Standards (MDS) (Ref. 4.7) (<http://www.roads.nebraska.gov/media/5593/nac-428-rules-regs-nbcs.pdf>), whichever is more stringent.

Consideration should be given to the placement of intersections and driveways with respect to vertical curves. When an intersection or a driveway must be placed on a crest vertical curve, it should be placed as near to the crest as possible. When an intersection or driveway is located slightly past the crest, inadequate sight distance may be a problem for both the motorist approaching on the minor roadway or driveway who cannot see oncoming mainline traffic and for motorists on the major roadway who cannot see the intersection or driveway. Where practicable, the PI's of crest vertical curves should be located at or near the intersection of the roadway centerlines. Chapter Three: Roadway Alignment, Section 3.C, discusses design controls for crest vertical curves.

1.C.5 Design Vehicle

A design vehicle is defined by the **Institute of Transportation Engineers** as “the vehicle that must regularly be accommodated on a thoroughfare without encroachment into other travel lanes”. The dimensions and operating characteristics of the design vehicle are used to establish highway design controls, such as the intersection or driveway radius. Selection of a design vehicle is influenced by the roadway type and the traffic composition. In selecting the appropriate design vehicle, the designer should keep in mind periodic usage of the intersection or driveway, such as the prevalence of large trucks at a grain elevator during harvest. EXHIBIT 4.9 gives the **NDOT** minimum design vehicle to be used under various intersection conditions. For additional information see the *Green Book* (Ref. 4.1), Section 2.8, “Design Vehicles” in Chapter 2. Examples of minimum path turning templates are shown in **FIGURES 2-10** through **2-32** of the *Green Book* (Ref. 4.1).

INTERSECTING HIGHWAY OR ROADWAY	MINIMUM DESIGN VEHICLE *
INTERSTATE / RAMP TERMINALS	WB-67
EXPRESSWAY / MAJOR ARTERIALS	WB-67
LOCAL ROADS / COUNTY ROADS / FRONTAGE ROADS	S-BUS 36
RESIDENTIAL / LOCAL STREETS	SU OR P
COMMERCIAL DRIVE / FARM EQUIPMENT DRIVE	SU
PRIVATE ROAD / FARM DRIVE / RESIDENTIAL DRIVE	P

* Use for design of intersection/ drive geometry only, not to be used in the calculation of intersection sight distance. The use of a design vehicle smaller than the minimum listed in the table requires **Unit Head** approval.

Exhibit 4.9 Guidelines for the Selection of Intersection/ Driveway Design Vehicles

1.C.6 Intersection Radius

- Urban intersections should have a minimum radius of 30 feet for 90° intersections.
- Rural intersections should have a minimum radius of 50 feet for 90° intersections.

The design of an intersection radius should be based on turning path templates of the selected design vehicle. These templates indicate wheel paths under ideal conditions; allowances should be made to provide a margin of error on the part of the driver.

A computer turning template program, such as *AutoTURN*[®], may be used to determine the intersection geometry. A graphical procedure may also be used to determine the minimum intersection radius by placing the selected vehicle turning template on the intersection plan. To fit the WB-67 turning template, a combination of circular arc and short tapers may be the best solution (See EXHIBIT 4.3).

The minimum allowable distance between the edge of the full depth pavement and the outside edge of the tires of the turning design vehicle is 2 feet; the desirable distance is 3 feet.

1.C.6.a Left Turn Radii

A typical at-grade intersection does not have a continuous edge of pavement delineating the left turning path; the motorist has a guide at the beginning and at the end of the left turn movement provided by pavement markings or channelization. In some instances, pavement markings are provided to guide turns through wider intersections.

The design values for left turn radii are a function of the:

- Design vehicle
- Angle of intersection
- Number of lanes
- Median width

Left turn radii should be larger than required by the minimum design vehicle since the turning radius is based on a 10 mph operating speed and this speed can often be exceeded in actual operations. For roadways intersecting at right angles, left turn radii that range between 60 feet and 75 feet will normally satisfy all of the controlling factors. For dual turning movements a minimum radius of 90 feet should be applied to retain a satisfactory capacity in the outer lane.

1.C.7 On-Street Parking

On-street parking in the immediate vicinity of an intersection may obstruct the driver's line of sight, impede traffic flow, and contribute to the crash potential. Parking should not be placed within 20 feet of the intersection crosswalk of any unsignalized intersection (See **Figure 3B-21** of the *MUTCD*, Ref. 4.2); parking near signalized intersections will be controlled by the requirements for dedicated turn lanes. See Chapter Ten: Miscellaneous Design Issues, Section 13, of this manual for additional information.

1.C.8 Transit Services

Urban intersections which are on bus routes should be designed to coordinate the operation of bus turnouts with the movement of through traffic. The designer will consult with **Traffic Engineering** regarding the location and length of the bus turnout, which may be placed on the near side or far side of the intersection. **NDOT** prefers the far side for signalized intersections. In either case, bus service may interfere with the intended operation of an intersection. Bus turnouts, merging tapers, and/ or passenger loading space of sufficient length to accommodate the maximum number of buses anticipated at any given time should be provided, if practicable, to minimize interference with intersection operation. For additional information see Section 4.19, "Transit Facilities", in Chapter 4 of the *Green Book* (Ref. 4.1).

1.C.9 Signs

The placement of signs at or near an intersection shall be in accordance with the *MUTCD* (Ref. 4.2) and with the *NE-MUTCD* (Ref. 4.3). The designer will coordinate the design of the typical section and the geometry of the approach roadway with **Traffic Engineering** to allow for proper sign placement. The designer should also verify that intersection sight distance is not compromised either by the nature or the number of signs to be installed (or already in place).

1.C.10 Pedestrian Crosswalks

Curb ramps shall be constructed or reconstructed to meet the guidance found in the Proposed Guidelines for Pedestrian Facilities in the Public Right-of-Way (With 2013 Supplement) (*Proposed Guidelines (2013)*) (Ref. 4.9) (<http://www.access-board.gov/guidelines-and-standards/streets-sidewalks/public-rights-of-way/proposed-rights-of-way-guidelines>) on all projects, as required. For further information, see Chapter Sixteen: Pedestrian and Bicycle Facilities, Section 7; Chapter Seventeen: Resurfacing, Restoration and Rehabilitation (3R) Projects, Section 16; and Chapter Fourteen: Traffic, Sections 1.H and 4.A, of this manual. For pedestrian design at roundabouts, see Chapter 6 of NCHRP Report 672, "Roundabouts: An Informational Guide", Second Edition (Ref. 4.18).

1.C.11 Bike Lane - Highway Intersections

Bike lane design at intersections should allow both motorists and bicyclists to operate following normal rules of the road with a minimum of confusion. Intersections without bike lanes but with significant bicycle traffic may require additional traffic control study. Refer to Chapter Sixteen: Pedestrian and Bicycle Facilities, Section 4, and the Guide for Development of Bicycle Facilities (Ref. 4.10), (http://safety.fhwa.dot.gov/ped_bike/docs/b_aashtobik.pdf) for additional information. For bike lane design at roundabout intersections, see Chapter 6 of NCHRP Report 672, "Roundabouts: An Informational Guide", Second Edition (Ref. 4.18).

1.C.12 Railroad Crossings

Railroad crossing design must consider approach grades, sight distance, drainage, highway traffic volumes, and the frequency of train movements. See Section 3.A of this chapter and Chapter Ten: Miscellaneous Design Issues, Section 1, for information regarding railroad-highway grade crossings.

1.D Turn Lanes

When **Traffic Engineering** has determined that specific turning movements should be separated from through movements they will recommend that a turn lane be added to the project. While the use of a turn lane may increase the capacity of an intersection, roadway widening for turn lanes may require additional right-of-way and could impact adjacent properties, drainage patterns, and driveway operations in the vicinity of the intersection.

Traffic Engineering may recommend right turn lanes, offset right turn lanes, free flow right turn lanes, or left turn lanes as warranted (See EXHIBITS 4.10 & 4.12). See Chapter 9 of the *Green Book* (Ref. 4.1) for additional discussion.

A right turn lane may be recommended for the following reasons:

1. To serve right turn vehicles which are required to slow for the turn movement, alleviating delays to arterial traffic and reducing the potential for rear-end crashes.
2. To move the stop bar position back on the minor approach, widening the throat entry for left turning vehicles from the arterial roadway. This serves to provide better visual “targeting” for the driver, aid larger vehicles to avoid edge drop-off, and reduce turning time which reduces the through lane clearance time requirements.

Right-turn lanes on rural, high-speed (≥ 50 mph), non-signalized roadways should be offset (See Section 1.D.3 of this chapter).

Shoulders adjacent to 12 foot wide right turn lanes should be 4 feet in width when surfaced, with an additional 2 foot turf transition, and 2 feet in width when turf.

Left turn lanes should be provided on the mainline at signalized intersections, if warranted. The following situations may necessitate the addition of an exclusive left turn lane:

- Where fully protected left turn signal phasing is to be provided
- Where left turn volumes exceed 100 vph and space is available
- Where left turn volumes exceed 300 vph, dual left turn lanes should be considered

Left turn lanes may be necessary on two-lane highways where traffic volumes are high.

Left turn lanes should be provided on divided arterial routes at intersections and at other median breaks where left turn volumes and/ or vehicle speeds are high. To reduce the obstruction of the line of sight by opposing traffic, the left turn lanes in 18 feet wide raised medians should be designed with a 1 foot offset. Wide striping on the right side of the left turn lane should be used to encourage traffic to move closer to the median (See [EXHIBIT 4.11](#)).

Two-way left turn lanes (TWLTL) have been constructed in urban areas in lieu of raised medians. **Traffic Engineering** will determine when TWLTL treatment is appropriate. TWLTL treatments provide the advantages of:

- Reduced travel time
- Improved capacity
- Ability to use the TWLTL as a travel lane during closure of a through lane
- Wide acceptance from abutting property owners

Providing a TWLTL may be preferable to having vehicles make U-turns at intersections or traveling around the block to reach a destination. Median widths of 12 feet to 16 feet wide are most adaptable to TWLTL conversion.

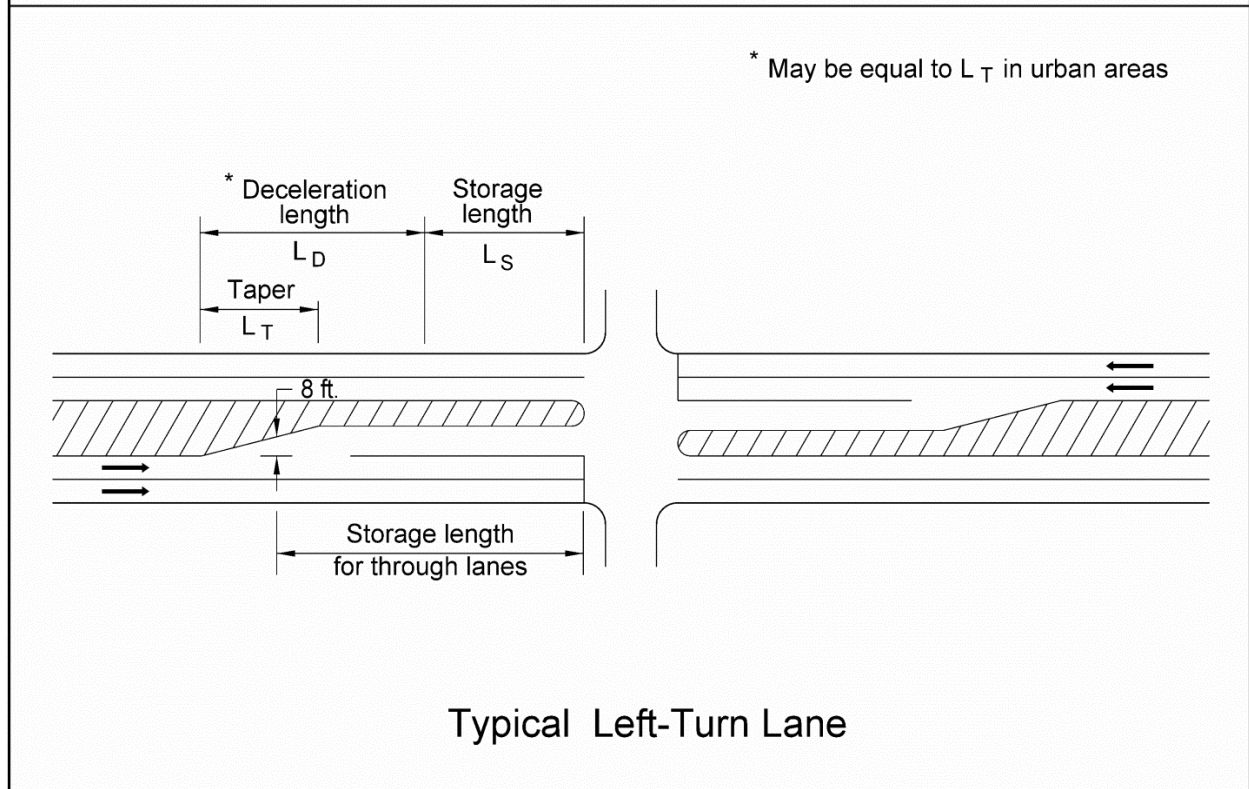
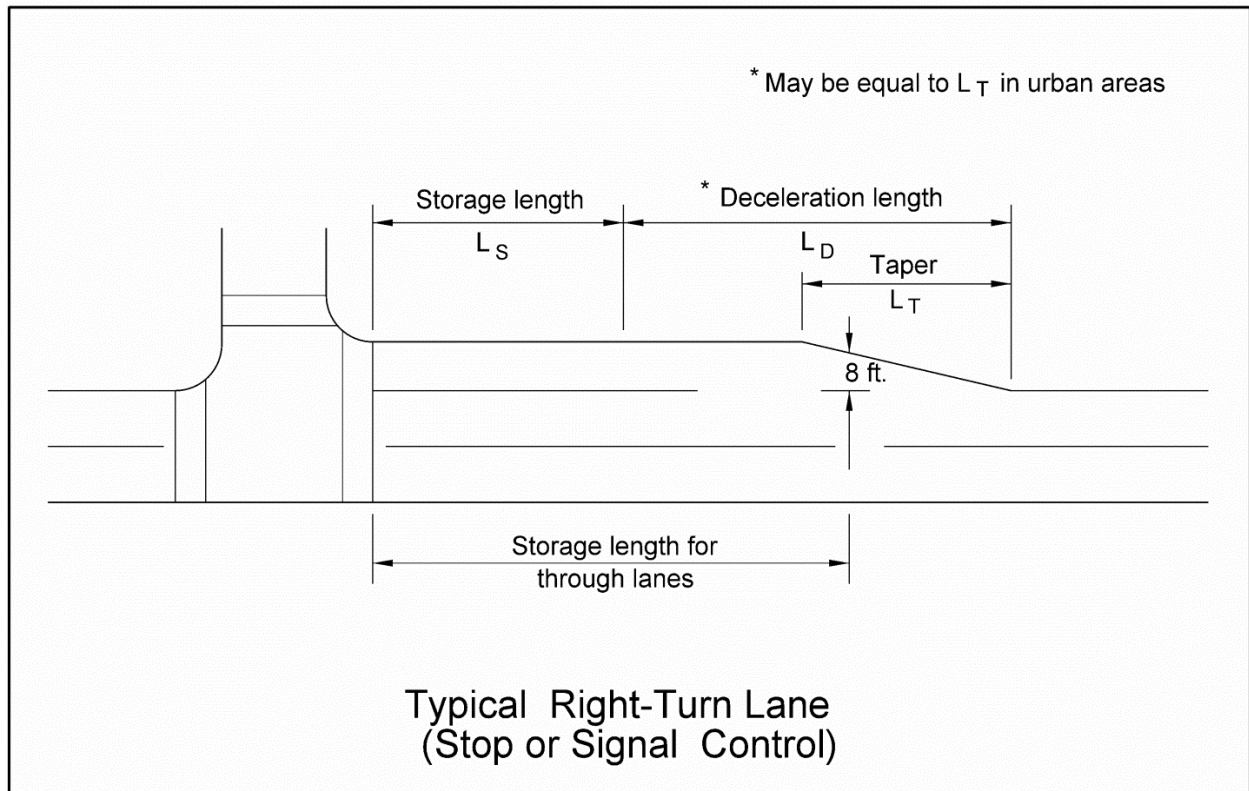

Exhibit 4.10 Typical Auxiliary Lanes

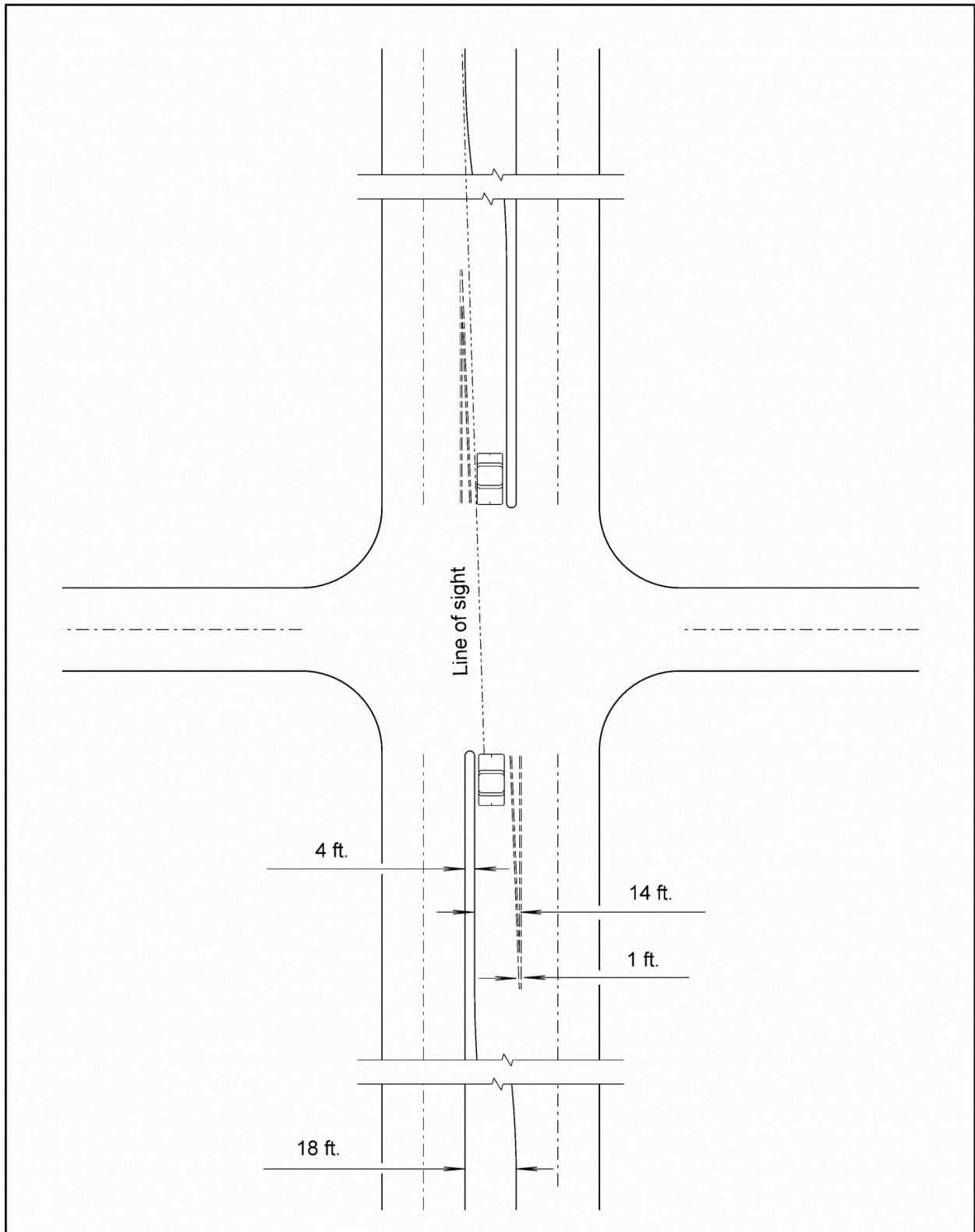

Exhibit 4.11 18 Foot Median, Left-Turn Lane

1.D.1 Turn Lane Length

Turn lane length is a function of the:

- Through traffic volumes
- Turning traffic volume
- Required storage length
- Approach design speed
- Length required to decelerate from the approach design speed to a stop
And
- Type of intersection control

Turn lane length has three components:

- Entering taper
- Deceleration length
- Storage length

Sufficient deceleration length should be provided to allow motorists to slow from the highway design speed to a comfortable stop, based on a comfortable deceleration rate of 6.5 ft./ sec.² (See [EXHIBIT 4.24](#)). In urban areas with lower design speeds and more closely spaced intersections, it may not be feasible to provide the entire deceleration length. In these locations some deceleration may occur prior to entering the auxiliary lane.

The storage length should provide sufficient space so that neither turning nor through traffic blocks the other. A minimum length of 50 feet (storage space for two passenger cars) should be provided for speeds < 40 mph. A minimum 100 ft. of storage should be provided for high-speed and rural roadways. The roadway designer will consult with **Traffic Engineering** to determine the recommended storage length at an intersection.

For additional information, see Chapter 9, Section 9.7.2, “Deceleration Lanes” and **Tables 9-21** and **9-22** in the *Green Book* (Ref. 4.1).

1.D.2 Turn Lane Bay Taper Rate

The entering turn lane bay taper rate should be 15:1 for rural high-speed roadways (design speed ≥ 50 mph) (See [EXHIBITS 4.9, 4.10, AND 4.25 THROUGH 4.39](#)); the turn lane bay taper length should equal the posted speed limit (at a minimum) for low-speed roadways (design speed ≤ 45 mph).

1.D.3 Offset Right-Turn Lanes

An offset right-turn lane is intended to provide an unobstructed sight triangle for the driver stopped on the minor road by providing a raised or painted island between the mainline roadway and the right-turn lane. An offset right-turn lane is generally used when recommended by **Traffic Engineering** or at the discretion of the **ADE**.

NDOT prefers the use of the tapered offset right-turn lane at unsignalized intersections on high-speed roadways (See [EXHIBIT 4.12](#)). A parallel type offset should be used when spillback off of the crossroad is anticipated (e.g. a train track runs parallel to the mainline, a congested driveway is downstream of the intersection on the crossroad). **ADE** approval is required to design a parallel offset right-turn lane. The design guidance for an offset right-turn lane (2-lane and 4-lane roadways) includes:

1. The median island on the minor road should be 10 feet from the edge of the through lane (face of curb to the edge of the traveled way), regardless of shoulder width.
2. Assume that the driver's eye is 21 feet from the edge of the nearest through lane.
 - a. Per Section 9.5.3 of the *Green Book* (Ref. 4.1), the 7.5 second $t(g)$ is for the driver's eye at 14.5 feet from the edge of the nearest through lane.
 - b. Add 0.27 sec to $t(g)$ to adjust for the additional 6.5 feet of travel.
3. Design the Intersection Sight Distance (ISD) for 5 mph over the posted or anticipated speed limit.
4. Design the intersection sight line to the left for the vehicle crossing the nearest lane, including 4-lane roadways. On 4-lane roadways double check that a vehicle in the near lane at the required ISD does not block a vehicle in the second lane over (far lane) at the required ISD.
 - a. The near lane $ISD = 1.47 \times V \text{ mph} \times 7.77 \text{ sec}$.
 - b. Far lane $ISD = 1.47 \times V \text{ mph} \times 8.27 \text{ sec}$.
5. Assume that the sight line is from the driver's eye to the middle of the nearest lane at the required ISD.
6. Place the outside of the tapered right-turn lane 12 feet outside of and parallel to this line.
7. Design a 2-foot lugout from where the outside edge of the right-turn lane is 2 feet from the edge of the nearest driving lane.

For further information, see "Offset Right-Turn Lanes for Improved Intersection Sight Distance" (Ref. 4.19).

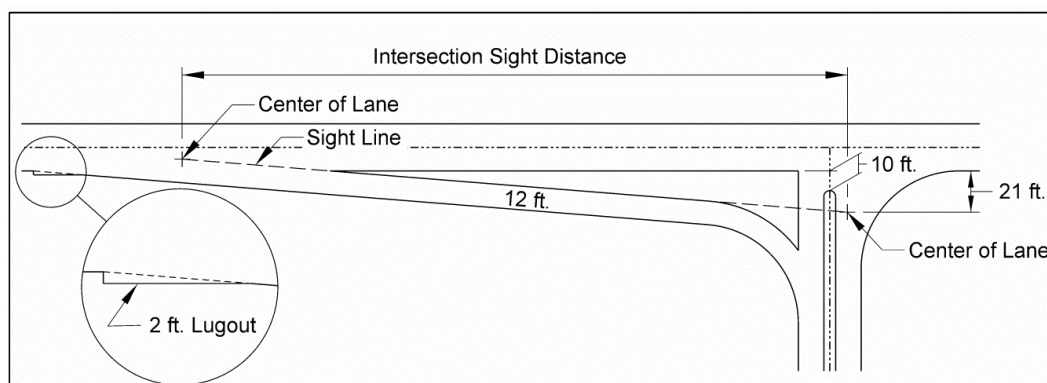

Exhibit 4.12 Tapered Offset Right-Turn Lane

1.D.4 Turning Roadways at Intersections (Free-Flow Right Turn Lanes)

Based on the traffic counts and composition, **Traffic Engineering** may recommend the design of a turning roadway. Turning roadways are channelized right-turn lanes at intersections, providing free flow turn movements. The design of a turning roadway usually consists of a deceleration lane leading to a horizontal curve, providing a gradual speed reduction and a more natural turning path for the driver. For additional information see Section 3.3.11, “Widths for Turning Roadways at Intersections”, in Chapter 3 of the *Green Book* (Ref. 4.1).

1.E Traffic Control

The purpose of traffic control is to regulate, warn, and guide traffic efficiently through intersections. Traffic control design is governed by warrants discussed in *MUTCD* (Ref. 4.2) and the *NE-MUTCD* (Ref. 4.3). Traffic control is the responsibility of **Traffic Engineering**.

There are four types of traffic control:

1. No control, where motorists must be able to see and evaluate the intersection and traffic situation in sufficient time to stop.
2. Yield control, where vehicles on the minor approach yield to vehicles on the major route; all vehicles yield to vehicles in a roundabout.
3. Stop control, where vehicles on either the minor or all approaches must stop prior to entering the intersection.
4. Signal control, where the approach legs of the intersection are controlled by a traffic signal.

Traffic Engineering conducts an engineering study to evaluate the operation of an intersection and to determine the appropriate traffic control to be provided. It is essential that the roadway designer coordinate with **Traffic Engineering** regarding roadway geometry, intersection capacity, and traffic operations (See Chapter Fourteen: Traffic of this manual).

Coordination with the **Rail Unit** in the **Local Assistance Division** is required where highway intersection signals are interconnected with rail-highway crossing signals (See Chapter Ten: Miscellaneous Design Issues, Section 1, of this manual).

See Section 9.11.2, “Traffic Control Devices” in Chapter 9 of the *Green Book* (Ref. 4.1), Part IV of the *MUTCD* (Ref. 4.2), and the *NE-MUTCD* (Ref. 4.3) for further discussion.

1.E.1 Unsignalized Intersections

The simplest form of installed traffic control at an intersection is the use of a yield sign for the roadway having the lower traffic volume. As the traffic volume increases the minor street can be controlled by a stop sign. All roadway approaches at an intersection may be controlled with a four-way stop.

An unsignalized intersection does not normally require auxiliary lanes. The time required for each vehicle to accelerate and pass through an average intersection, after stopping or slowing to yield, is typically 3-4 seconds. When this delay increases (e.g. when truck traffic has limited opportunity to clear the intersection), as queues become commonplace for the minor roadway, and/ or when a crash history is established as drivers take more risks to enter perceived gaps in traffic, the level of service of the intersection degrades. In these situations, **Traffic Engineering** may recommend the addition of auxiliary lanes to the intersection.

1.E.2 Signalized Intersections

Traffic signals usually provide more efficient traffic operation where large volumes of traffic must be accommodated by allocating time to specific traffic movements. Essentially, signalization moves vehicles in groupings or "platoons" in order to reduce delays caused by the starting and stopping of individual vehicles.

In urban areas with multiple signalized intersections, the designer must consider the progressive nature of traffic signal system coordination, where it is desirable to move vehicle platoons from one intersection to the next. Each succeeding intersection must be configured to handle the approach volumes and to store or channelize the required turning movements. The designer must coordinate with **Traffic Engineering** to verify that the proposed approach lanes and intersection design is capable of accommodating the design year traffic volumes.

2. DRIVEWAYS

Access will be provided to all properties but it may be from joint access locations, from side roads, or from frontage roads. When access locations are consolidated in rural areas, driveways on one side of the highway should be located opposite driveways on the other side of the highway. Access will conform to the Access Control Policy to the State Highway System (Ref. 4.12) (<http://www.roads.nebraska.gov/media/3460/access-control-policy.pdf>).

The designer should avoid an excessive number of entrances. Keep in mind that:

- Approaches are expensive
- Some existing field entrances may no longer be required
- Each driveway presents a potential conflict with highway traffic
- Each driveway could represent an obstruction in the recovery area

Recommendations for access locations should be made during the plan-in-hand inspection. If there is any question about the need for access, the situation should be investigated during the plan-in-hand or other field inspection.

Any proposed change of a field entrance or driveway location in a rural area will be coordinated with the **Right-of-Way Division (ROW)** and with the **Utilities Unit in Roadway Design (Utilities)** to verify that there are no utility conflicts. Location changes of urban driveways will be coordinated with **ROW, Utilities, the Lighting Unit, and Traffic Engineering**. Driveway locations should not change after the design plans have been submitted to **PS&E**.

For additional information see An Informational Guide for Preparing Private Driveway Regulations for Major Highways (Ref. 4.13), the Access Control Policy to the State Highway System (Ref. 4.12), and Chapter Fifteen: Right-of-Way, Section 3.

2.A Rural Driveways

The following guidelines should be referred to when designing field entrances and driveways in rural locations:

1. Check the project file and/ or consult with the **Unit Head** for the requirements regarding access control on the project prior to locating or designing driveways.
2. To discourage wrong-way movement, rural access openings and driveways should not be located within 300 feet of a median opening unless the access opening or driveway is directly opposite the median opening.
3. Joint access to adjoining properties should be provided where practicable, the access opening should be centered on the property line. Joint access will usually require the purchase of permanent right-of-way easements.
4. Driveways should be located at or near the crest of vertical curves. Driveways located past the crest of a vertical curve may not be visible to approaching traffic.
5. The maximum desirable grade for rural access openings is $\pm 8\%$. In a high cut or deep fill situation, a maximum grade of $\pm 15\%$ is allowable.
6. The grade of the shoulder slope or flatter should be continued along the driveway for a minimum of 20 feet beyond the edge of the shoulder before breaking to a steeper slope.
7. On a project where the earthwork is measured in embankment, the earthwork required for the construction of the driveways and field entrances must be included in the earthwork totals (See Chapter Seven: Earthwork, Section 4.B.1, of this manual).
8. The provision of adequate driveway length to allow agricultural equipment to pull completely off of the roadway should be considered.
9. Inform the **Pavement Design Engineer** in **M&R** of any drives on a project which are expected to carry farm equipment; these drives may require thicker surfacing to support the heavier loads being supported.

Depending on the traffic volume and composition, driveways in rural locations may be considered to be minor intersections and may include provisions for deceleration, turning movements, and acceleration.

EXHIBITS 4.14 & 4.15 show typical rural driveway designs. See EXHIBIT 4.13 for rural driveway design criteria. For additional information see Chapter Ten: Miscellaneous Design Issues, Section 10 “Mailbox Turnouts and Supports”, of this manual.

Driveway Type	Rural Driveway Width *		
	Residential Drive	Commercial Drive	Field Entrances
Single	Grade 26 feet Surface 24 feet R = 25 feet	Grade 42 feet Surface 40 feet R = 40 feet	Grade 26 feet R = 25 feet
Joint Use (Driveway on property line)	Grade 26 feet Surface 24 feet R = 25 feet	Grade 42 feet Surface 40 feet R = 40 feet	Grade 42 feet R = 25 feet

Notes: The width of the surfaced shoulder will not be subtracted from the driveway radius.

* Measured at the throat of the driveway

Exhibit 4.13 Rural Driveway Width Criteria

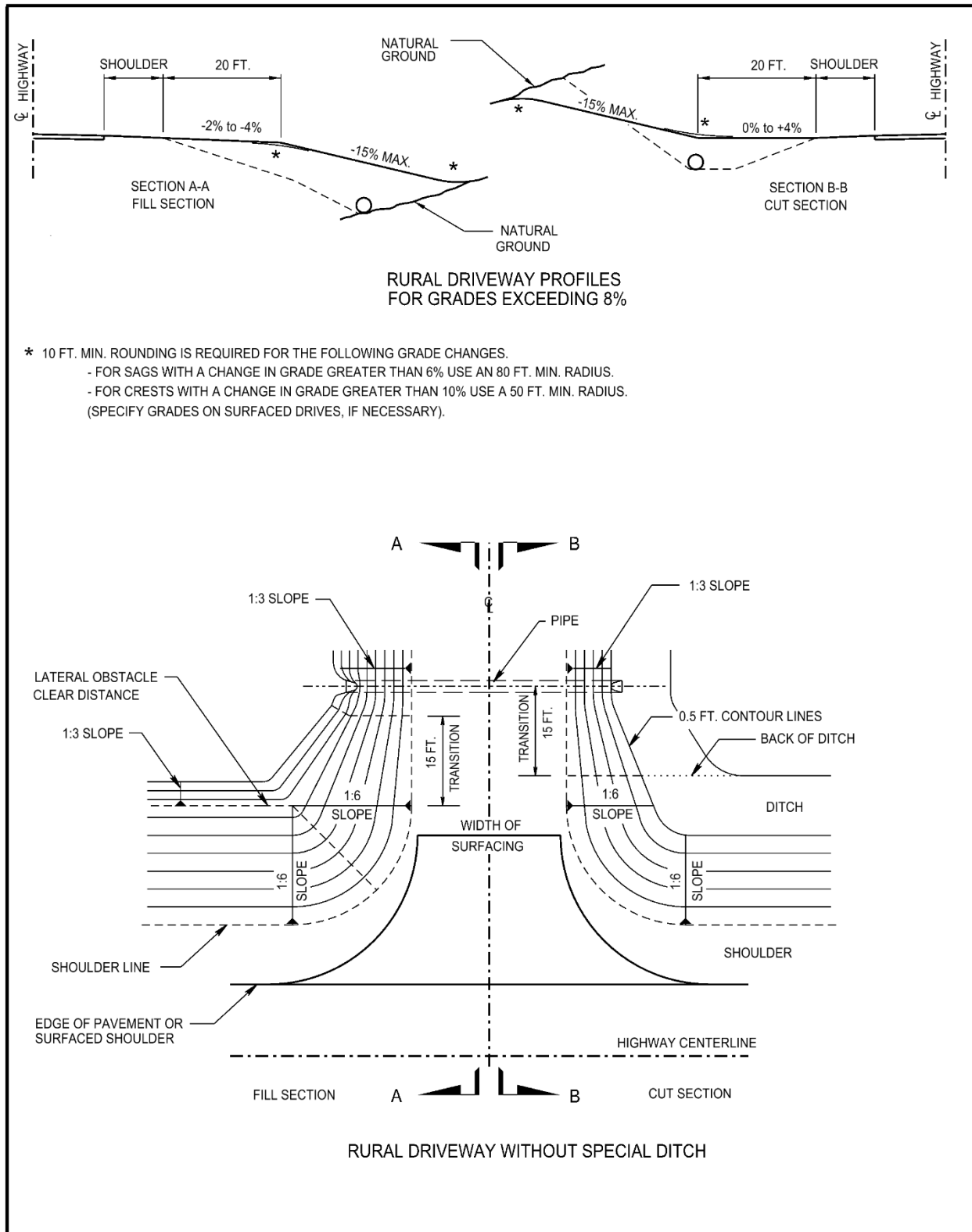

Exhibit 4.14 Rural Driveway Without a Special Ditch

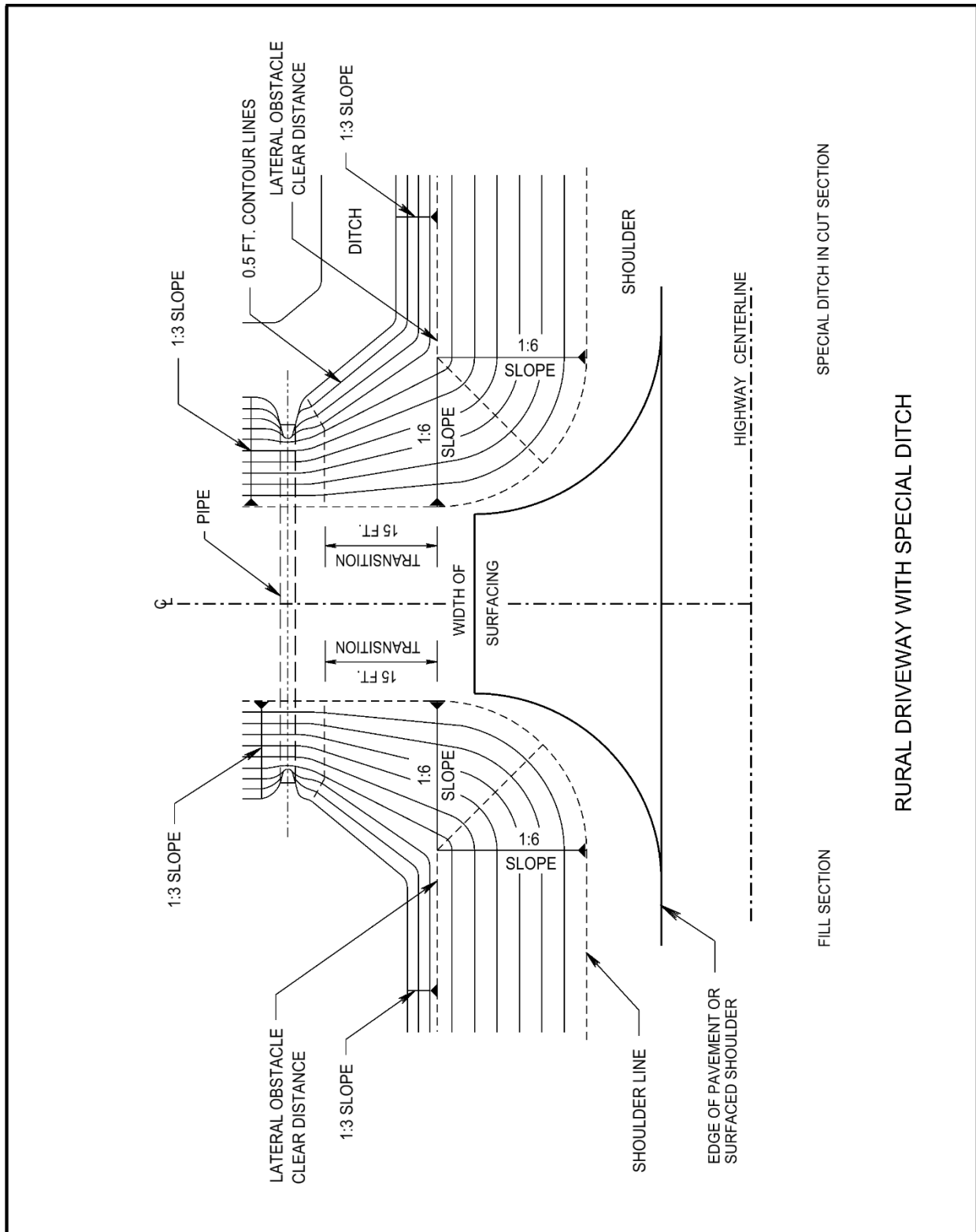

Exhibit 4.15 Rural Driveway With a Special Ditch

2.A.1 Rural Driveway Culvert Pipes

Driveway culvert pipes will be provided, where required, as a grading item. The following items should be considered in the design of rural driveway culvert pipes:

1. Driveway culvert pipe locations should be noted on the plan-in-hand field inspection.
2. The preferred location for a driveway culvert pipe is at the back of the ditch bottom, outside of the lateral clear zone (See [EXHIBITS 4.14 & 4.15](#)).
3. A minimum of 1 foot of cover should be provided over the culvert at the driveway shoulder break point (See [EXHIBIT 4.16](#)).
4. The minimum driveway culvert pipe diameter is 18 inches (24-inch diameter pipes are normally used). Larger culvert pipe diameters may be required based on the ditch hydraulics (See the [Drainage Design and Erosion Control Manual \(Drainage Manual\)](#), Chapter One: [Drainage](#), Sections 6, 7 & 8 (Ref. 4.15) (<http://www.roads.nebraska.gov/business-center/design-consultant/rd-manuals/>).
5. Driveway culvert pipes will meet the requirements of the pipe material policy (See Appendix C, "Pipe Material Policy", of the *Drainage Manual*, Ref. 4.15) and Section 721 of the [Standard Specifications for Highway Construction \(Spec Book\)](#) (Ref. 4.16) (<http://dot.nebraska.gov/media/10343/2017-specbook.pdf>).

2.A.2 Hydraulic Design of Driveway Culverts

Driveway culverts are typically not analyzed for hydraulic capacity, based on the assumption that the highway ditch immediately adjacent to the driveway location only carries localized runoff from the pavement and highway right-of-way. The designer must be aware of the expected flows within the ditch at the drive location. If the driveway culvert carries flows from the lower end of a long vertical curve, the low side of a superelevated curve, and/ or the ditch carries any additional drainage from the outside of the right-of-way, hydraulic capacity should be evaluated.

A Design Storm Frequency for hydraulic design of driveway culverts is not specifically designated in the *Drainage Manual* (Ref. 4.15). However, each type of highway facility (Interstate, Expressway, and Rural Highways classified by ADT) has an associated design storm designation by policy (See [EXHIBIT 1.3](#) of the *Drainage Manual*, Ref. 4.15). According to 23 CFR 650.105: "Design Flood shall mean the peak discharge, volume if appropriate, stage or wave crest elevation of the flood associated with the probability of exceedance selected for the design of a highway encroachment. By definition, the highway will not be inundated from the stage of the design flood."

Designers should be aware of the sentence underlined above; all aspects of design should be in conformance with it. In other words, the primary consideration for all culvert design, including driveway culverts, should be to keep the highway from being inundated by the Design Storm event. It is the designer's responsibility to verify that culvert headwater and/ or overtopping does not inundate or encroach onto the highway pavement.

In most cases, it is not necessary to design the driveway culvert for the same return period as the highway culverts. It may be permissible to allow driveway overtopping to occur at low volume, low risk driveway locations as long as there is no encroachment of Stormwater onto the highway. It is necessary to consider and evaluate the potential impacts to the highway when the capacity of a driveway culvert is exceeded, including increased maintenance activities and damage to adjacent properties. The highway may be impacted when the capacity of culverts under driveways or county road intersections has been exceeded, especially when the highway is at a lower elevation than the driveway or county road.

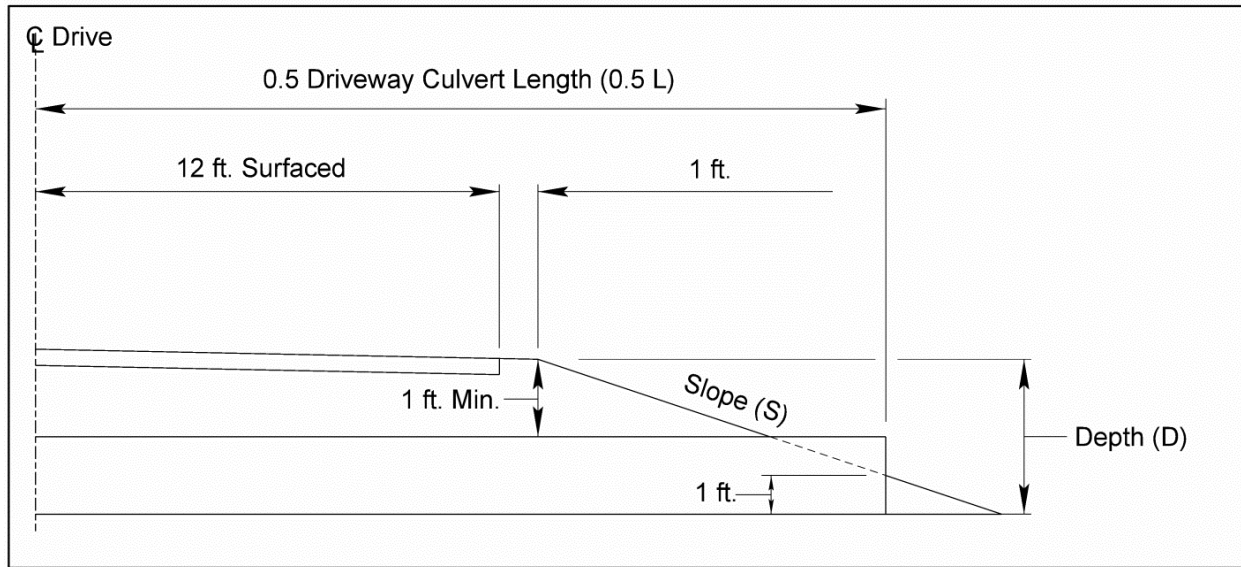

26 FOOT WIDE DRIVEWAY *				
DEPTH (D)	SIDE SLOPE (S)			
	1:3 ¹	1:4 ²	1:6 ³	1:10 ⁴
3 feet (Min. D for a 24 inch Culv.)	38 feet	42 feet	50 feet	66 feet
3.5 feet (Min. D for a 30 inch Culv.)	41 feet	46 feet	56 feet	76 feet
4 feet (Min. D for a 36 inch Culv.)	44 feet	50 feet	62 feet	86 feet
4.5 feet (Min. D for a 42 inch Culv.)	47 feet	54 feet	68 feet	96 feet
5 feet (Min. D for a 48 inch Culv.)	50 feet	58 feet	74 feet	106 feet
5.5 feet (Min. D for a 54 inch Culv.)	53 feet	62 feet	80 feet	116 feet
6 feet	56 feet	66 feet	86 feet	126 feet
6.5 feet	59 feet	70 feet	92 feet	136 feet
7 feet	62 feet	74 feet	98 feet	146 feet
7.5 feet	65 feet	78 feet	104 feet	156 feet
8 feet	68 feet	82 feet	110 feet	166 feet
MINIMUM DRIVEWAY CULVERT PIPE LENGTH (L)				

* To determine the driveway culvert length for the maximum driveway width of 42 feet, add 16 feet to L.

For ditch depths other than those given:

1. Add 6 feet to L for each additional 1 foot of depth.
2. Add 8 feet to L for each additional 1 foot of depth.
3. Add 12 feet to L for each additional 1 foot of depth.
4. Add 20 feet to L for each additional 1 foot of depth.

Exhibit 4.16 Minimum Rural Driveway Culvert Pipe Lengths

2.B Urban Driveways

The number of urban driveways should be minimized to reduce the potential for accidents and to maintain highway capacity. Joint use driveways are desirable in urban locations to limit conflict points. Access control will be acquired for any urban tract where an existing driveway is closed (See Chapter Fifteen: Right-of-Way, Section 3, of this manual). Driveway access should be located outside of the storage length at signalized intersections in order to avoid conflicting movements and false signal actuations. Driveway design with signal controls requires a traffic analysis by **Traffic Engineering** to coordinate signal design and the roadway/ intersection geometry.

The majority of driveway design in urban areas involves improvements to existing locations. Factors to be considered include:

- Traffic composition
- Right-of-way
- Accommodation of existing access
- Development of property being served
- Development of adjacent properties
- Access control regulations and requirements
- Location of curb inlets

All new urban driveway design will be in accordance with the criteria shown in EXHIBIT 4.17; see EXHIBIT 4.18 for a typical urban driveway design. Curb cut locations are governed by the Access Control Policy to the State Highway System (Ref. 4.12) and local ordinances. The geometry of the driveway will be referenced to the project centerline. Major driveways that are signalized should be designed as intersections. Driveway design involving shopping centers, truck stops, schools, plants with large parking lots, etc. require a special traffic analysis by **Traffic Engineering** to coordinate the number of lanes, traffic controls, and required storage lengths.

The allowable driveway grade between the 2-inch slope curb and the sidewalk, not including sidewalks located directly behind the curb, will be between +2.3% and +10%, with a maximum allowable grade of +15% with **ADE** approval.

Driveway Type	Urban Driveway Width *	
	Residential Drive	Commercial Drive
Single	12 feet minimum	40 feet maximum
Double	24 feet maximum, in existing locations only. Use single in new locations.	---
Joint Use (Driveway on property line)	24 feet desirable	40 feet maximum

Notes: The minimum urban driveway radius is 10 feet with 15 feet desirable and 25 feet maximum for commercial driveways.

* Measured at the throat of the driveway.

Exhibit 4.17 Urban Driveway Width Criteria

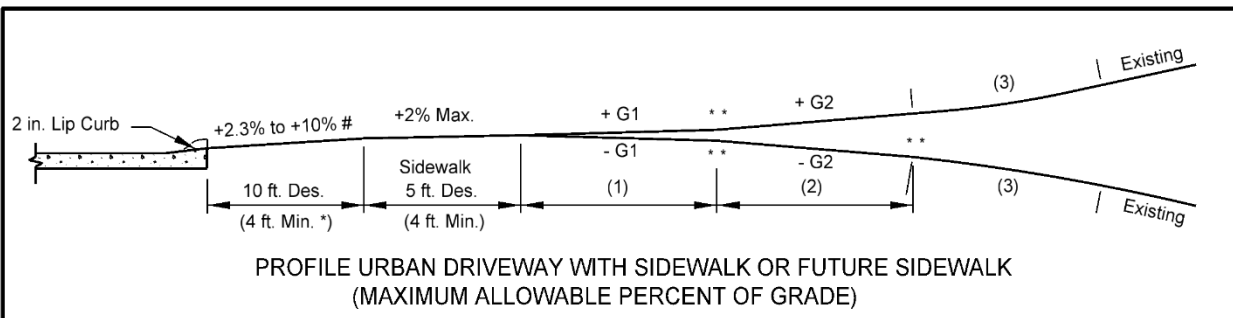

1. 10 ft. min. is required when the existing grade is greater than 8%.
 2. 10 ft. min. is required when the existing grade is greater than 15%.
 3. 10 ft. min. rounding is required when the existing grade is greater than 22%.
- * 0 ft. is allowed in urban business districts with sidewalks of 6 ft. min. width.
 - ** 10 ft. min. rounding desirable for the following grade changes:
 - For sags with a change in grade greater than 7% use an 80 ft. min. radius.
 - For crests with a change in grade greater than 10% use a 50 ft. min. radius.
- # A rise of 2 in. or less between the back of curb and the sidewalk will require an edge drain.

DRIVEWAY TYPE	G1 (MAX.)	G2 (MAX.)
COMMERCIAL, INDUSTRIAL	+/- 5%	+/- 8%
DWELLINGS (RESIDENTIAL)	+/- 8%	+/- 15%

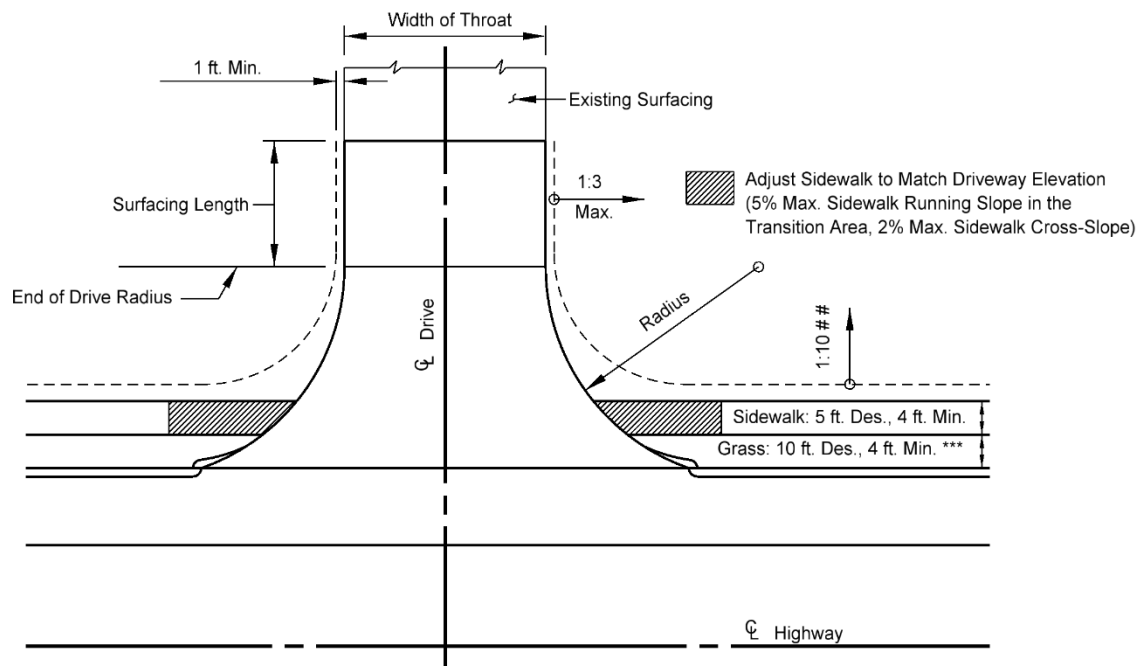

1:10 des., 1:6 min. within lateral obstacle clearance distance, then transition to 1:3 in 15 ft.
 *** 0 ft. allowed in urban business districts with sidewalks of 6 ft. min. width.

Exhibit 4.18 Urban Driveway

3. SURFACING

The determination of surfacing type for intersections and driveways is site specific; there are no absolute rules governing this topic. Surfacing type for intersections and drives should be addressed in the pavement determination and discussed at the plan-in-hand meetings, utilizing the **District's** local experience.

3.A Intersection Surfacing Guidelines

See EXHIBIT 4.19. Where parallel railroad tracks run within 200 feet of the edge of the pavement, the crossroad should be surfaced to the railroad right-of-way and may be surfaced to the tracks with **District Engineer (DE)** approval. Any work on railroad right-of-way requires the approval of the **DE** and a special provision prepared by the **Rail Unit** in the **Local Assistance Division**.

3.B Driveway Surfacing Guidelines

In most cases the limit of surfacing will be either to the end of the driveway radius or to the existing driveway surface, the choice will depend on which is the least distance from the edge of the pavement, allows for a suitable driveway grade, and matches into the remaining portion of the driveway. Check with the **DE** at the plan-in-hand for verification. See EXHIBITS 4.18 & 4.20 for examples.

Field entrances will not be surfaced except in the Sandhills Region; millings should be used to surface field entrances whenever possible (verify with the **DE** at the plan-in-hand field inspection).

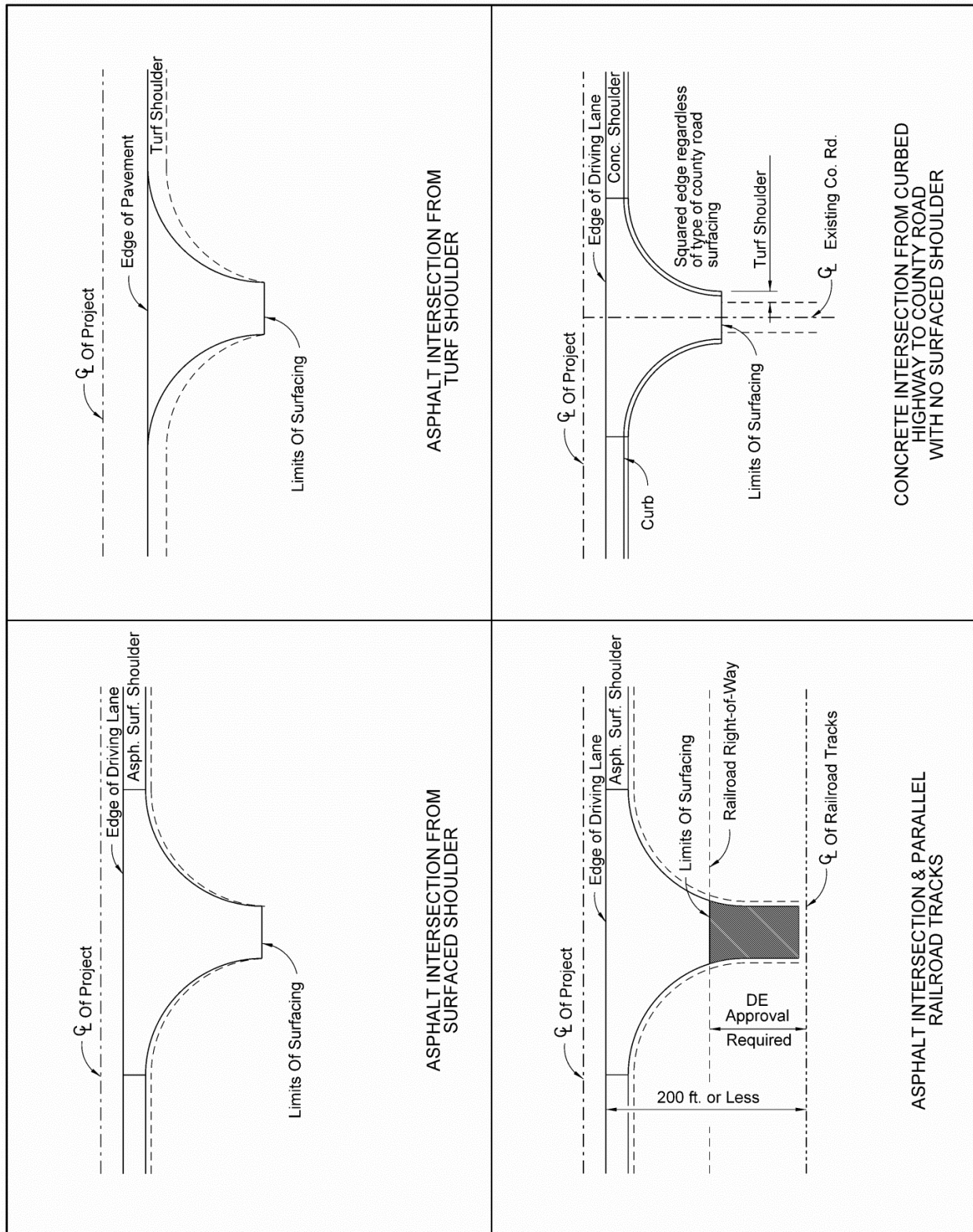

Exhibit 4.19 Limits of Surfacing at Co. Road Intersections and Other Public Roads

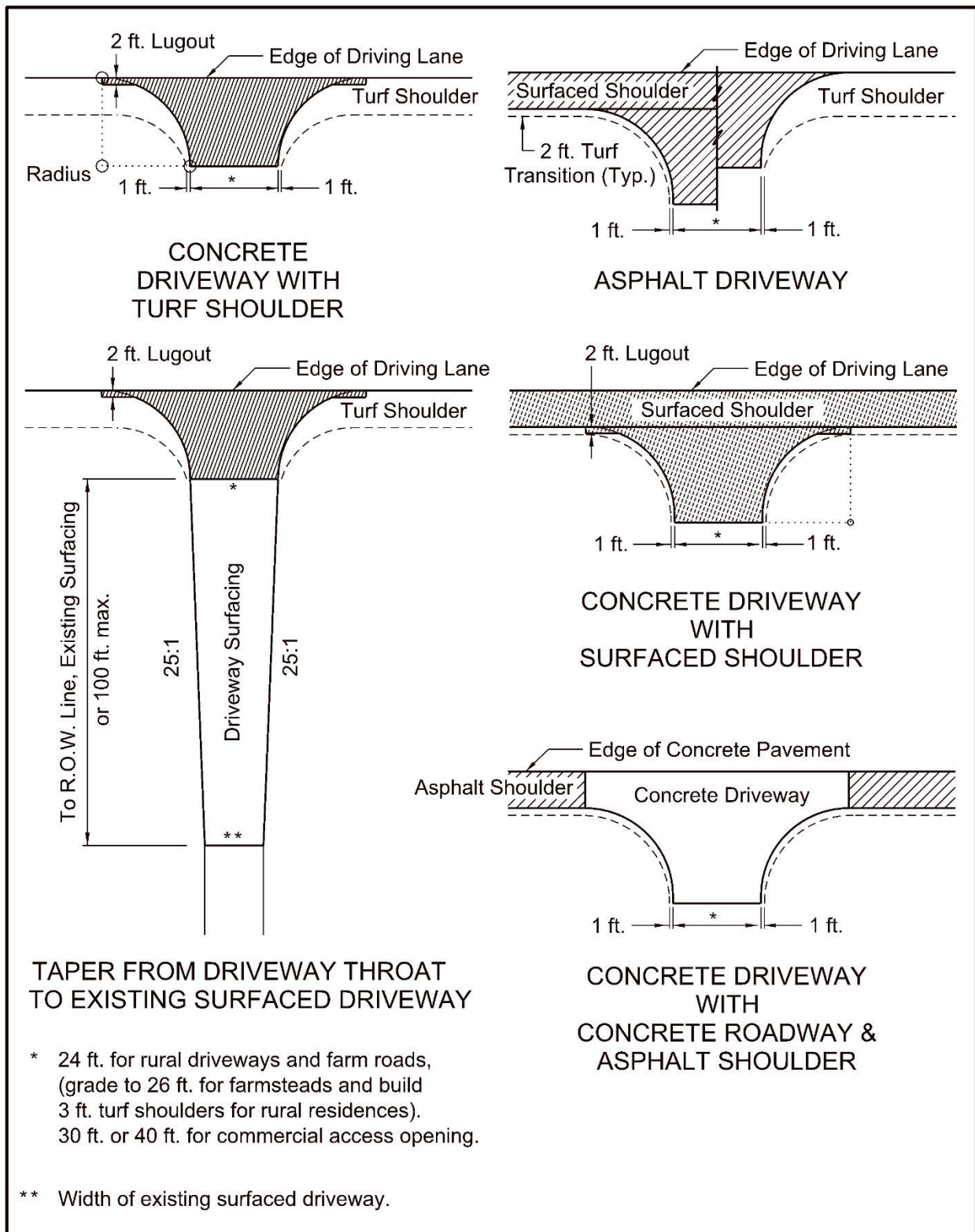

Exhibit 4.20 Surfacing Criteria for Rural Driveways

4. BUILD NOTES FOR INTERSECTIONS AND DRIVEWAYS

The following guidelines have been established for build notes for intersections and driveways:

1. Use "BUILD" in the note for driveways and intersections if any of the following conditions are present:
 - A new driveway or intersection is being constructed or an existing driveway or intersection is being relocated
 - The top width of the intersection or driveway is being changed
 - A new driveway pipe is being laid or an existing pipe is being re-laid
 - A new culvert pipe is being constructed within the radii of an existing surfaced intersection
2. Use "SURFACE" in the note for driveways and intersections if none of the above conditions are present. On resurfacing projects without surfaced shoulders, new roadway grading which is contoured around an existing intersection will not be considered as a change in the top width.
3. If a "BUILD" note is used for an intersection note, the words "and surface" will not be in the note.
4. If a "BUILD" note is used for a driveway note and the driveway is also to be surfaced, the words "and surface" will be included in the note.

5. CHANNELIZATION

Islands and medians may be used to divide and direct traffic. The degree of channelization required for a roadway is influenced by the patterns and volume of both vehicular and pedestrian traffic during peak periods. A traffic analysis, identifying the relative importance of conflicting movements, is performed by **Traffic Engineering** to establish the type of channelization to be used. Examples of channelized intersection designs are shown in EXHIBITS 4.21 & 4.22. The designer should coordinate with **Traffic Engineering** throughout intersection design regarding channelization and other issues.

The following guidelines should be considered when designing a channelized intersection:

1. Motorists should be confronted with no more than one decision at a time.
2. Turns greater than 90° and sudden sharp reverse curves should be avoided.
3. Areas of vehicle conflict should be reduced as much as possible.
4. Points of crossing or conflict should be evaluated for other possible treatments such as separation or consolidation with appropriate control devices.
5. Storage areas for turning vehicles should be provided clear of the through traffic lane.
6. Approach road designs based on refuge for vehicles in medians, to either turn left or to pass straight through, will not be considered.
7. Prohibited turns should be blocked wherever possible.
8. The location of traffic control devices should be established as a part of the channelization design.
9. Channelization may be desirable to separate various traffic movements where multiple phase signals are used.
10. All turning movements should be checked with the appropriate design vehicle (See EXHIBIT 4.9).
11. Lighting warrants should be checked when raised channelization is introduced at an intersection.

For additional information, see Section 9.6.2, "Channelization" in Chapter 9 of the *Green Book* (Ref. 4.1).

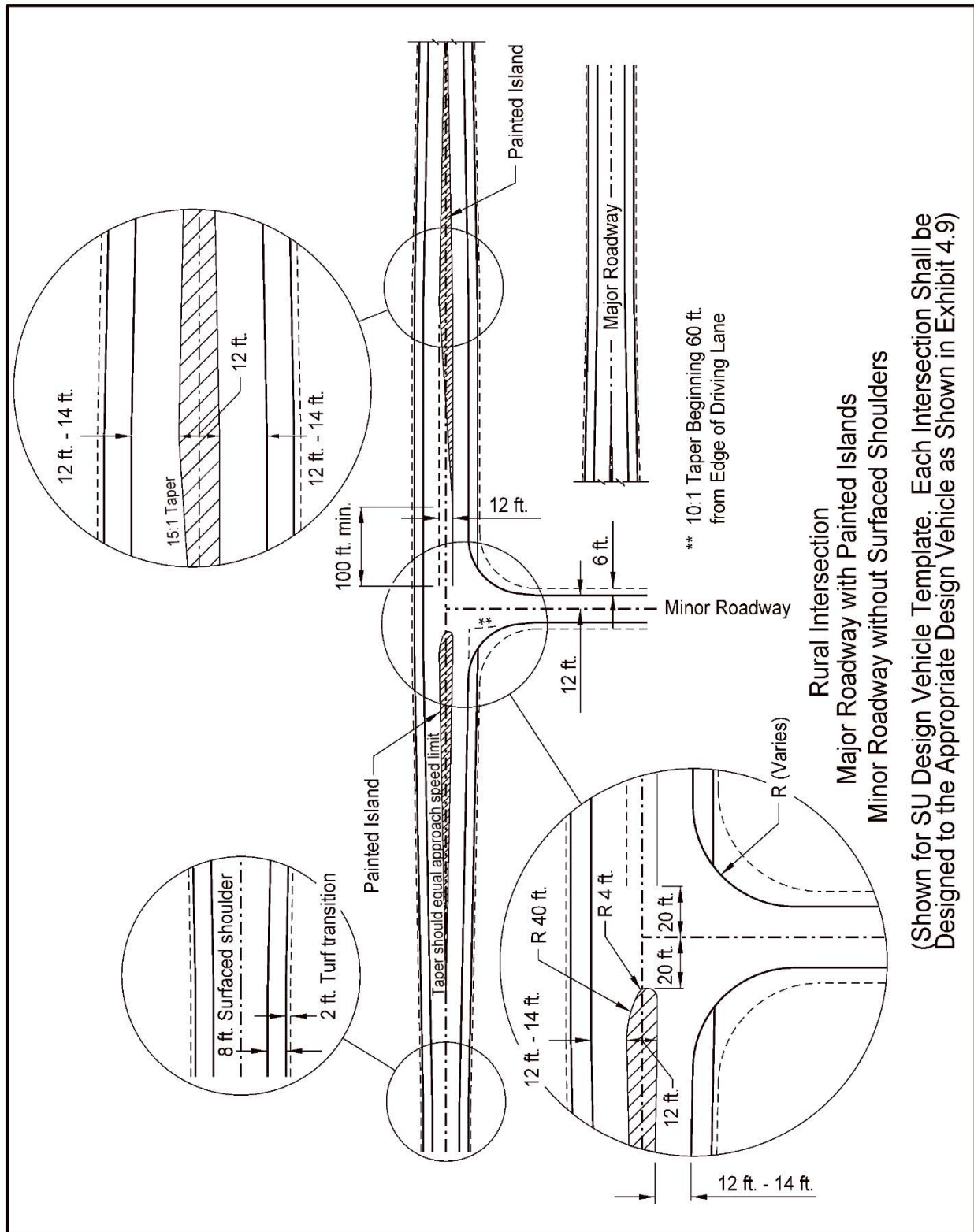

Exhibit 4.21 Example of Rural Three-Leg Intersection with Minor Roadway Without Surfaced Shoulder

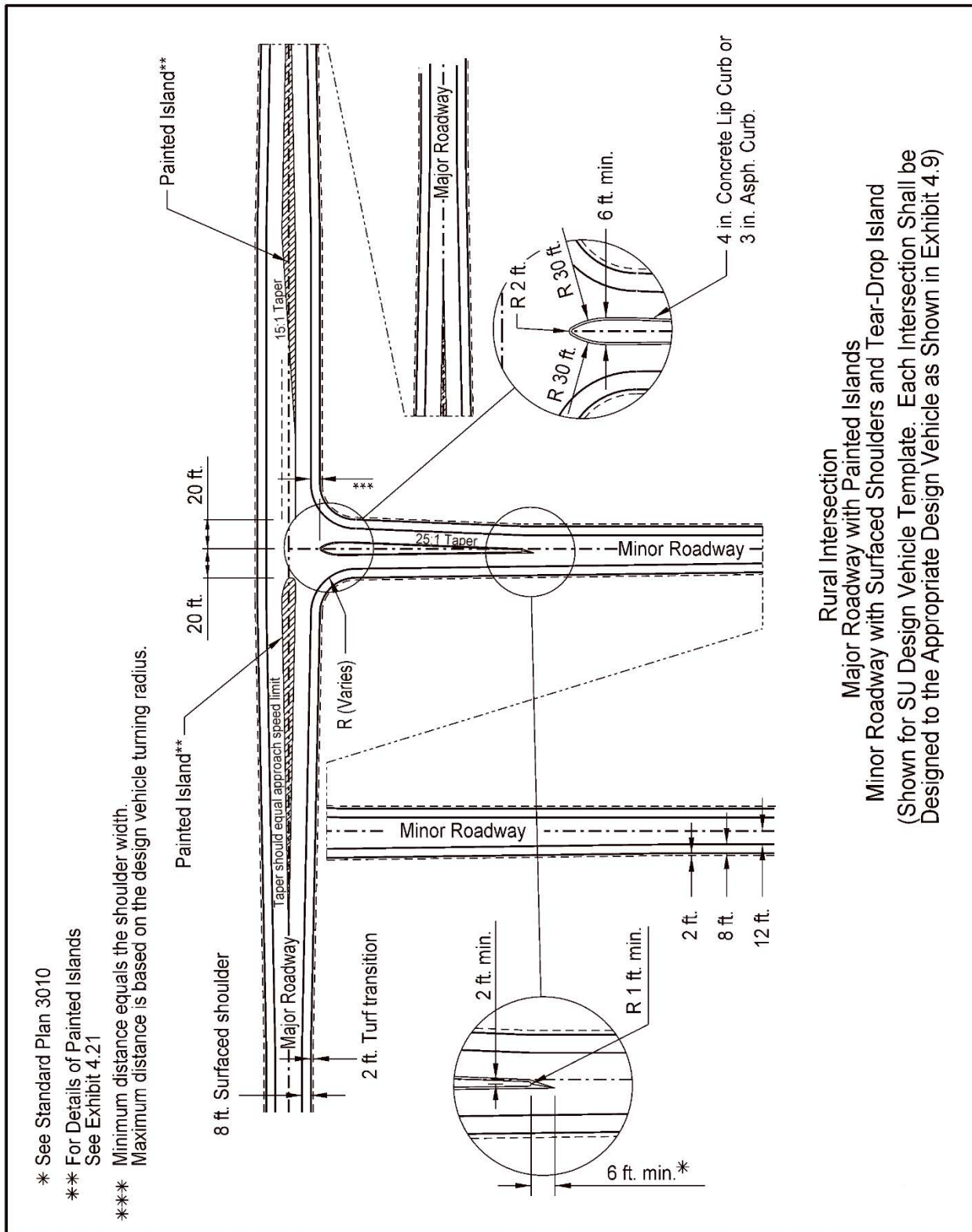

Exhibit 4.22 Example of a Rural Three-Leg Intersection with Minor Roadway With Surfaced Shoulder

5.A Islands

Islands should be designed to define the driving path. Islands may be flush or raised and may be delineated by surfacing materials or pavement markings.

For non-developed suburban crossroads, the following guidelines apply:

1. If the intersection warrants signalization within five years of the programmed construction the project may include signals, based on a recommendation from **Traffic Engineering**. A raised or flush median (determined on a project-by-project basis) and a left turn lane may be constructed. If access control is purchased along the mainline roadway it should extend up the cross road (See Chapter Fifteen: Right-of-Way, EXHIBITS 15.5, 15.6, & 15.7, of this manual).
2. If signals are not warranted within five years from construction but may be warranted at sometime within 20 years of construction, the grading may be accomplished for future islands and turn lanes but the paving will be constructed to two-lane, stop-control geometrics.

For urban and developed suburban crossroads, the following guidelines apply:

1. If signals are warranted within five years of construction, the project may include signals. An island and a left turn lane may be built.
2. If signals are not warranted within five years of construction, a standard two-lane intersection will be constructed. When signals are installed, the intersection will be reconstructed as required.

5.A.1 **Raised Islands**

Raised islands provide the most positive delineation and may be used to control undesirable turning movements.

The use of a raised island for pedestrian refuge should be considered if a crosswalk passes through the channelization. Raised islands may also be used for the placement of traffic signals. For concrete island and curb ramp details see the Standard/Special Plan Book (Standard Plans) (Ref. 4.14) (<http://www.roads.nebraska.gov/business-center/design-consultant/stand-spec-manual/>). See Chapter Sixteen: Pedestrian and Bicycle Facilities, Section 7, of this manual for information regarding pedestrian crosswalks.

The allowable curb height on raised islands is a function of the design speed. The following **NDOT** curb policy applies:

- On high-speed facilities (design speed \geq 50 mph), 3-inch and 4-inch concrete slope curb and 3-inch asphaltic concrete curb are permitted in both urban and rural settings (See EXHIBIT 6.16).
- On low-speed facilities (design speed \leq 45 mph), 6-inch integral concrete curbs are permitted (See EXHIBIT 6.16).

Lighting warrants should be checked when raised islands are used.

Teardrop raised islands on the minor roadway approach are acceptable at state highway intersections with high-volume roads (See [EXHIBITS 4.3 & 4.22](#)). These islands should be installed for placement of the stop sign when the intersection return must be widened to accommodate turning trucks. The designer should design the island and the intersection geometry so that it does not conflict with the design vehicle's turning movements.

5.B Medians

A median is defined as the portion of a divided highway which separates the opposing traffic lanes.

5.B.1 Median Uses

Medians on multilane highways and roadways may provide the following benefits:

- Separate opposing traffic movements
- Provide a recovery area for errant vehicles
- Facilitate the drainage on crowned multilane sections
- Prevent undesirable turning movements
- Provide space for deceleration lanes and storage for left turning vehicles
- Provide width for future lanes

5.B.2 Median Types

1. Flush Medians - Flush medians are typically used on urban highways and streets. These medians are often used as two-way left-turn lanes (TWLTL) in urban areas.
2. Raised Medians - Raised medians are typically used on urban and suburban highways and streets to control access and left turns (the *Standard Plans*, Ref. 4.14, shows a typical detail of a raised concrete median). The decision of whether to surface a raised median, and surfacing type, should be made on the plan-in-hand field inspection. Mow strips (a 2 foot surfaced section between the curb and the turf) may also be considered.
3. Depressed Medians - Depressed medians are typically used on freeways, where practicable, and on other divided arterials. Depressed medians have better drainage characteristics than raised medians.

[EXHIBIT 4.23](#) illustrates the different median types.

5.B.3 Median Width

The width of the median is the distance between the inside edges of the through travel lanes (See [EXHIBIT 4.23](#)). The median width depends on the type of facility, costs, existing and future development, and right-of-way limitations. The desirable depressed median width for an Interstate is 64 feet, the desirable depressed median width for a 4-lane freeway or expressway is 54 feet. Variations in median widths should be considered on a case-by-case basis at the plan-in-hand inspection. Roadway designers should check the width and placement of any piers in the median and, if necessary, adjust the roadway design accordingly. The width of the pier cap will also be checked to verify that the minimum allowable vertical clearance is being maintained (See Chapter Ten: [Miscellaneous Design Issues](#), Section 2.E, of this manual).

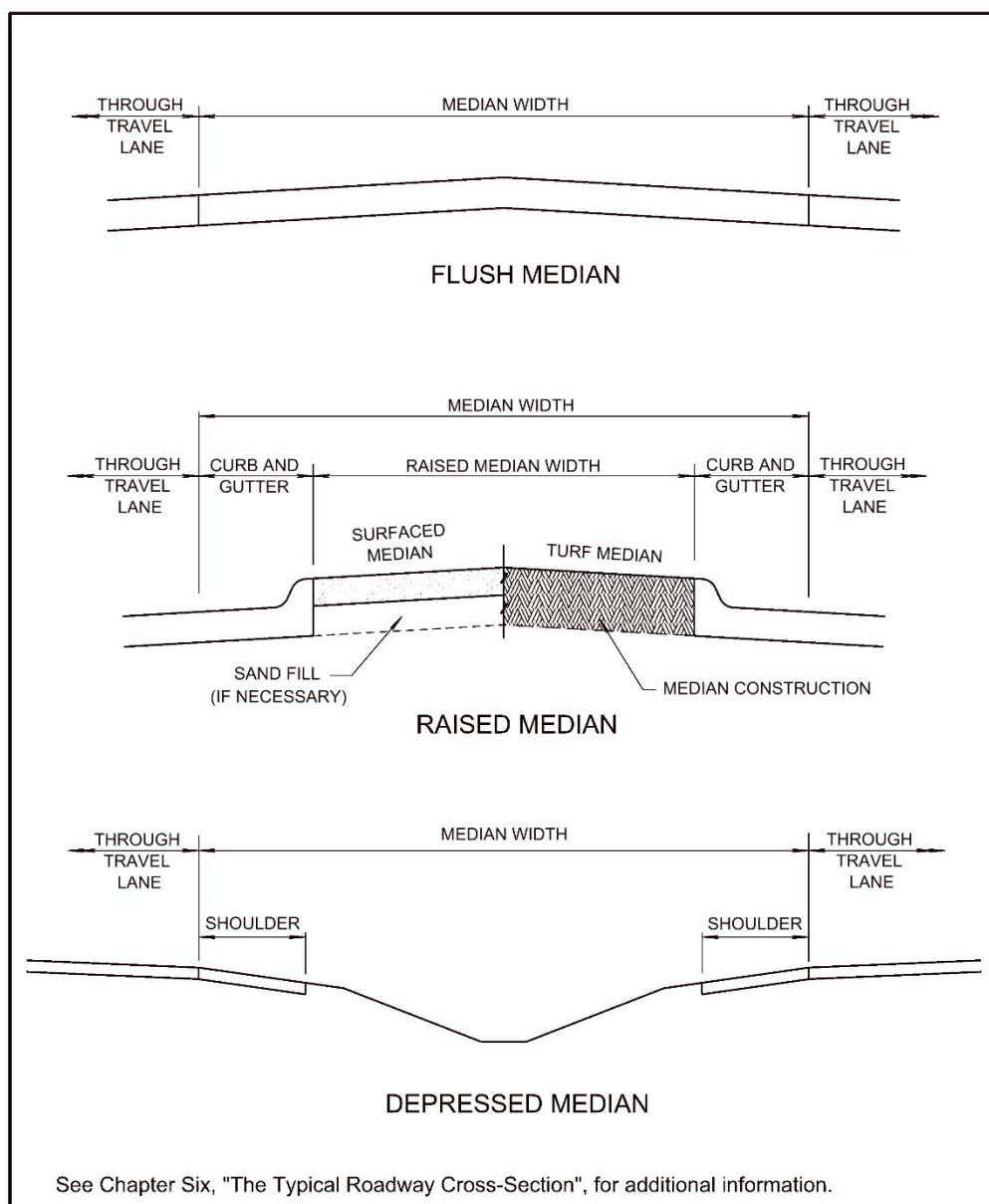

Exhibit 4.23 Median Types

5.B.4 Median Breaks

Median breaks may be provided to allow access to driveways and crossroads. The turning template for the appropriate design vehicle and the intersection/ driveway environment will be used to determine the median opening width and intersection/ driveway geometry. The designer should also check the effects of median channelization on neighboring intersections and driveways. Median openings are typically graded so that this pavement area drains away from the driving lanes.

Four types of median breaks may be used on divided roadways.

5.B.4.a Type A Median Breaks

Type A median breaks (EXHIBITS 4.25, 4.26, 4.28, 4.31 & 4.36) may be used at intersections of the mainline with roadways having a classification of "Other Arterial" or higher and at intersections with paved public roads where there is high probability of turning vehicles blocking the opposing turning driver's line of sight (the left turn lanes of a Type A median break are offset so that the driver's line of sight will not be obstructed). At other locations a special traffic study by **Traffic Engineering** will be required to justify the use of a Type A median break. Roadway designers will consult with their **ADE** when proposing the use of Type A median breaks. The length of a Type A median break consists of:

1. A lane change and deceleration distance to shift the turning traffic from the through lane and to slow the traffic to a full stop (See EXHIBIT 4.24). Note: the lengths given in EXHIBIT 4.24 are based on a deceleration rate of 6.5 ft./s². If this is not practicable, the Stopping Sight Distance (See the *Green Book* (Ref. 4.1), **Table 3-1**), based on a deceleration rate of 11.2 ft./s², may be used.

And

2. A storage length provided by **Traffic Engineering**. The minimum storage length will be 50 feet, providing storage for two cars at 25 feet per car, for speeds < 40 mph or 100 feet for high-speed and rural roadways. See the *Green Book* (Ref. 4.1), **Tables 9-21 and 9-22** for additional information.

5.B.4.b Type B Median Breaks

Type B median breaks (EXHIBITS 4.25, 4.27, 4.29, 4.32 & 4.37) are appropriate for use at mainline intersections with gravel county roads, with housing development intersections, and with rural commercial driveways. The length of a Type B median break consists of:

1. A lane change and deceleration distance to shift the turning traffic from the through lane and to slow the traffic to a full stop (See EXHIBIT 4.24). Note: the lengths given in EXHIBIT 4.24 are based on a deceleration rate of 6.5 ft./s². If this is not practicable, the Stopping Sight Distance (See the *Green Book* (Ref. 4.1), **Table 3-1**), based on a deceleration rate of 11.2 ft./s², may be used.

And

2. A storage length. The minimum storage length will be 50 feet, providing storage for two cars at 25 feet per car, for speeds < 40 mph or 100 feet for high-speed and rural roadways. See the *Green Book* (Ref. 4.1), **Tables 9-21** and **9-22** for additional information.

Traffic Engineering should be consulted for the appropriate storage length if the mainline traffic volume is over 9000 ADT, if the opposing peak hour traffic volume is over 500, if the peak hour turning traffic volume is 100 VPH or greater, and for rural commercial driveways.

5.B.4.c Type C Median Breaks

Type C median breaks (EXHIBITS 4.25, 4.27, 4.30, 4.33, 4.34, 4.38 & 4.39) are appropriate for use at mainline intersections with farmstead/ rural residence driveways. The length of a Type C median break includes a 15:1 taper to shift the turning traffic to the left of the through lane.

5.B.4.d Type D Median Breaks

Type D median breaks (EXHIBITS 4.29, 4.34 & 4.40) are used at an intersection with a field entrance.

Speed (mph)	Lane Change and Deceleration Distance (ft.)
20	70
25	105
30	150
35	205
40	265
45	340
50	415
55	505
60	600
65	700
70	815

Deceleration lengths are based on a 6.5 ft/s² deceleration throughout the entire length. Larger deceleration rates may be used when deceleration lengths based on 6.5 ft/s² are impractical.

Access points should not be located in the deceleration areas.

Exhibit 4.24 Desirable Lane Change and Deceleration Distances
 Source: **Table 9-20** of the *Green Book* (Ref. 4.1)

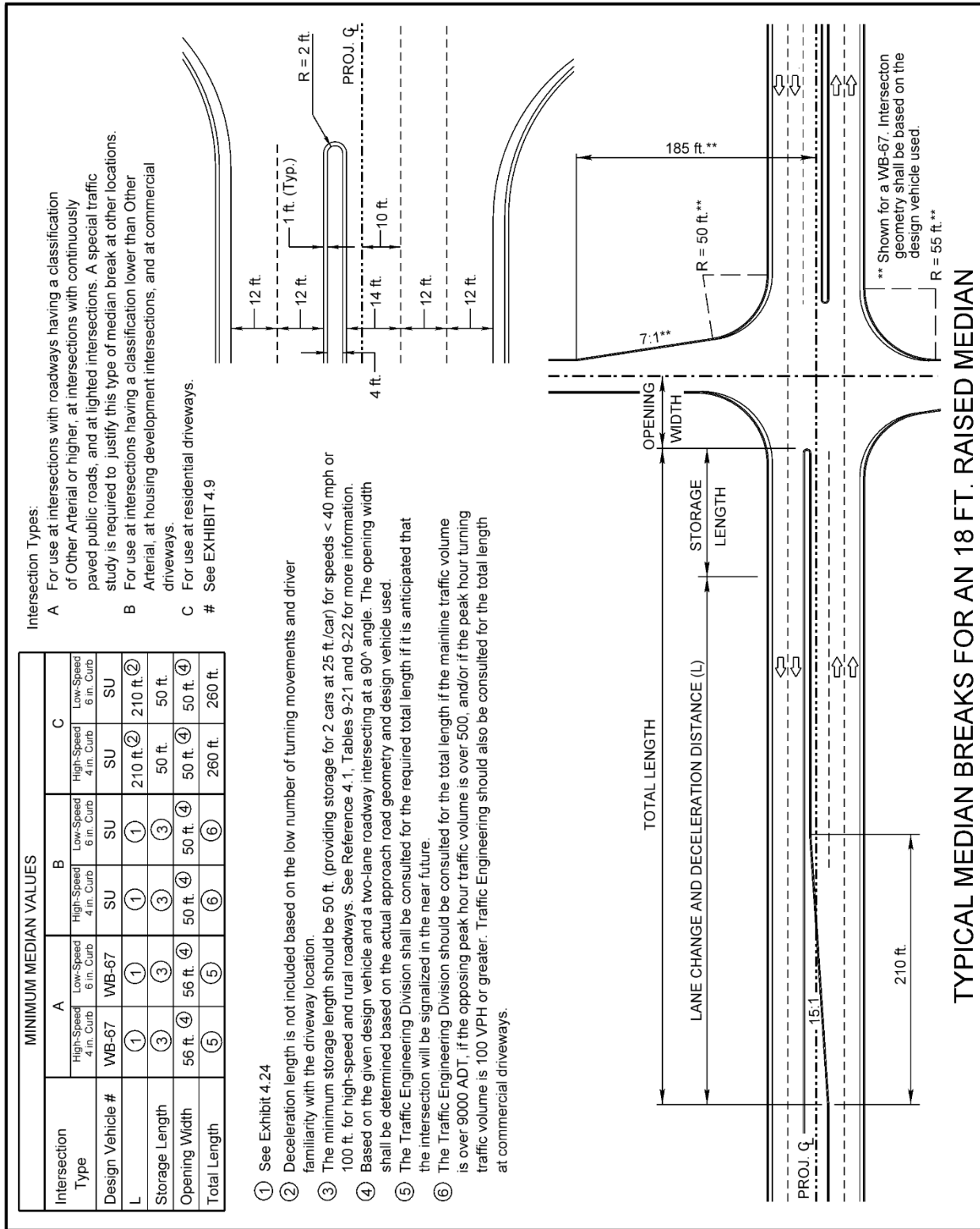

Exhibit 4.25 Typical Median Breaks (18 Foot Raised Medians)

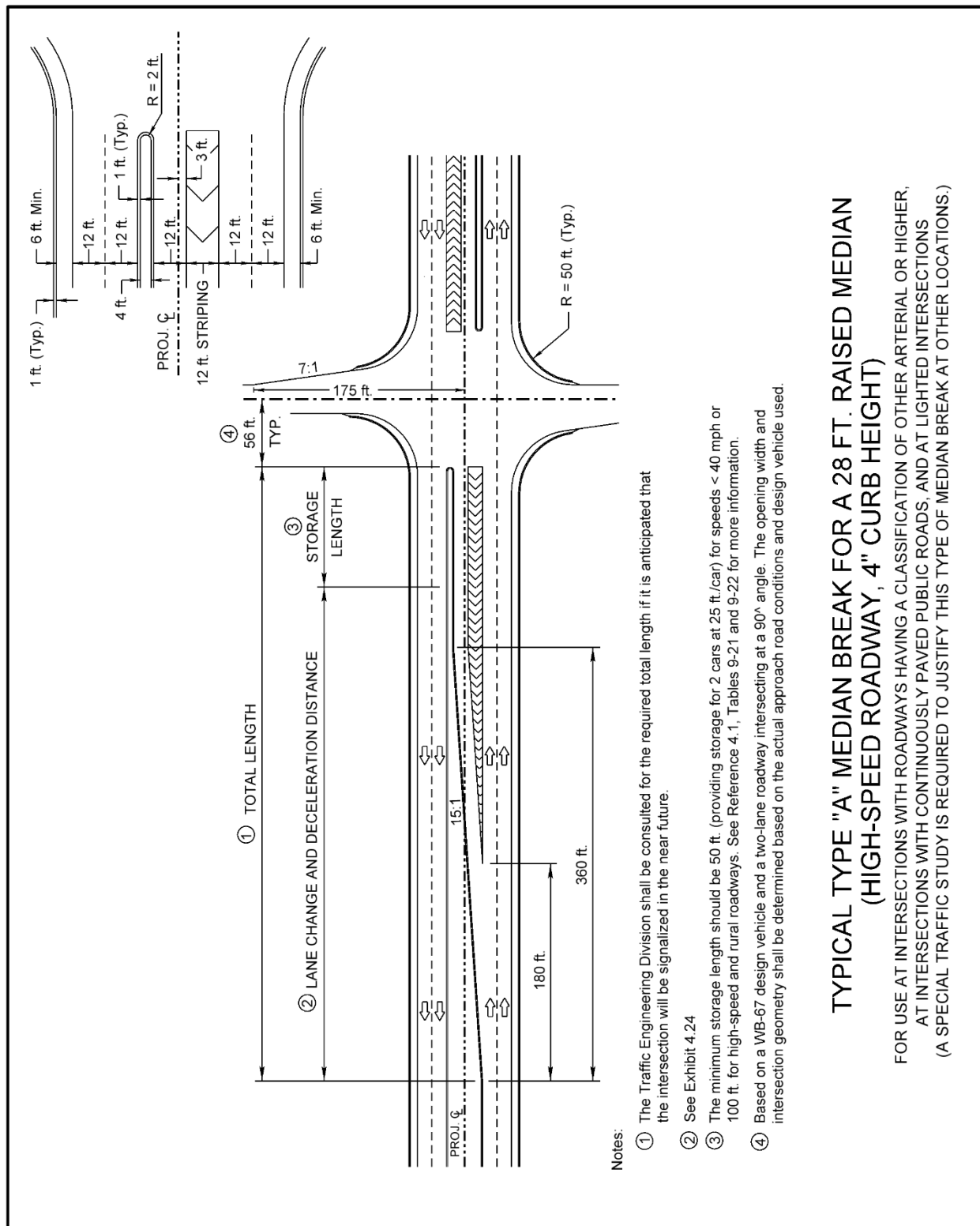

Exhibit 4.26 Typical Type A Median Break (28 Foot Raised Median)

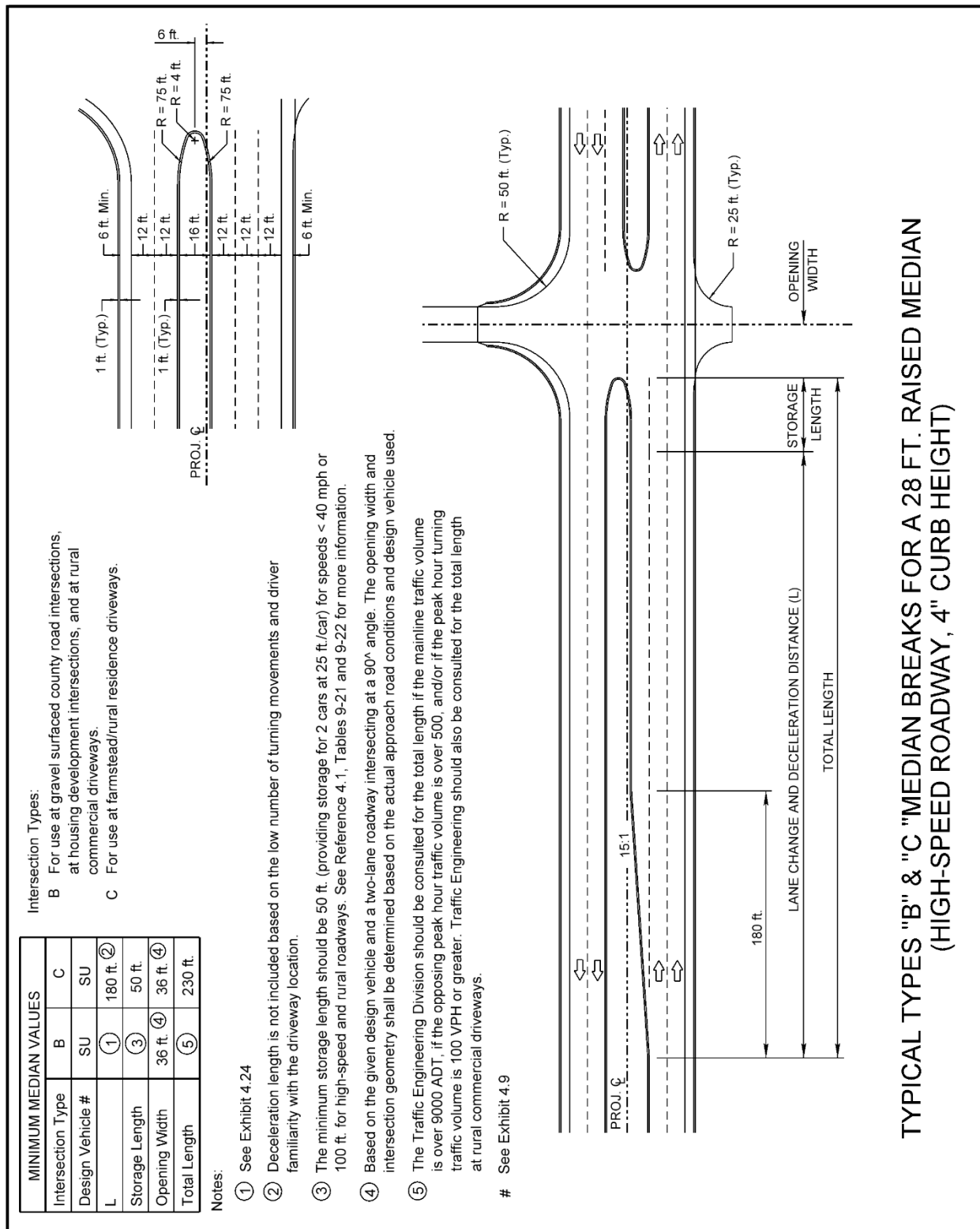
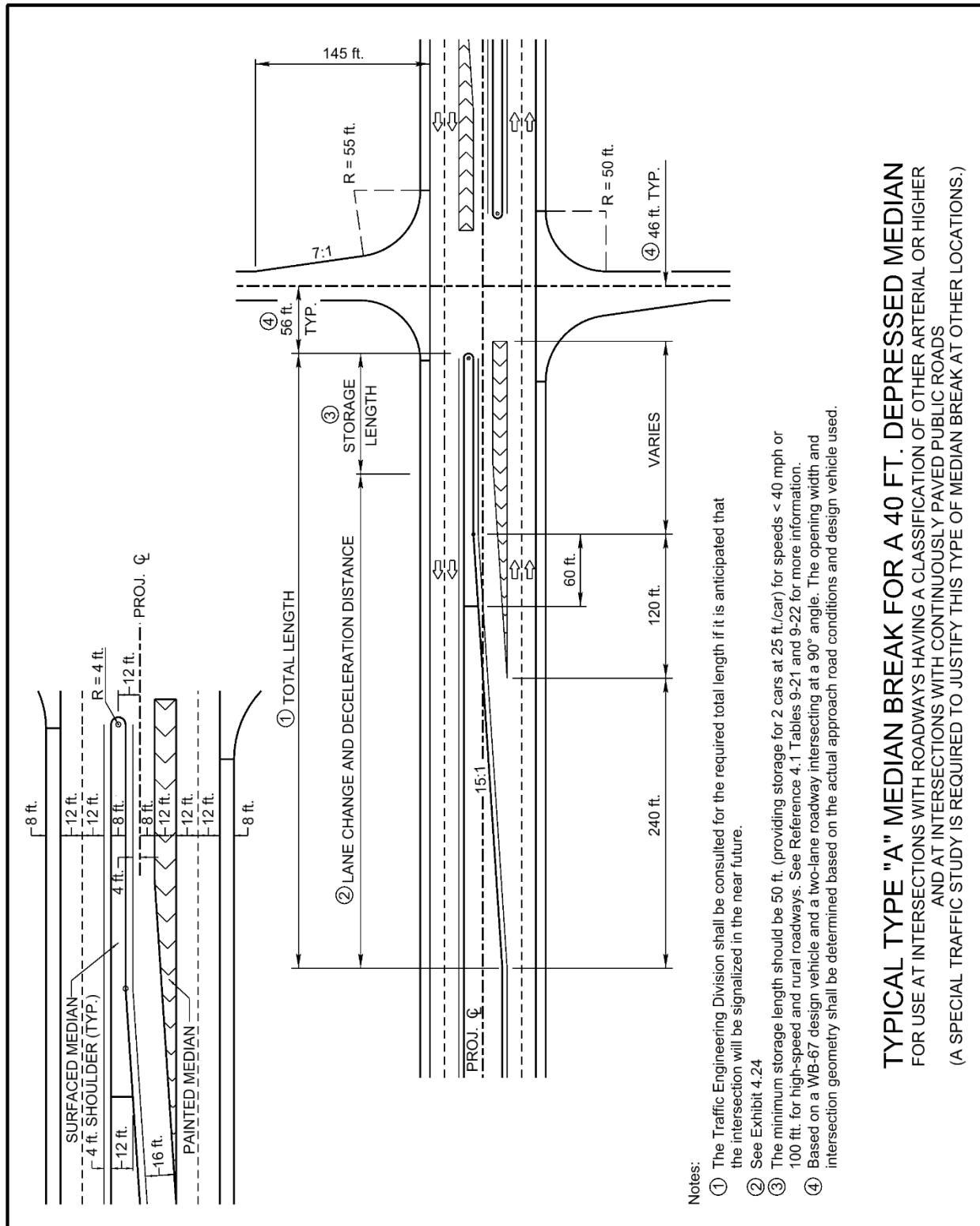

Exhibit 4.27 Typical Types B and C Median Breaks (28 Foot Raised Medians)



Notes:

- ① The Traffic Engineering Division shall be consulted for the required total length if it is anticipated that the intersection will be signalized in the near future.
- ② See Exhibit 4.24
- ③ The minimum storage length should be 50 ft. (providing storage for 2 cars at 25 ft./car) for speeds < 40 mph or 100 ft. for high-speed and rural roadways. See Reference 4.1 Tables 9-21 and 9-22 for more information.
- ④ Based on a WB-67 design vehicle and a two-lane roadway intersecting at a 90° angle. The opening width and intersection geometry shall be determined based on the actual approach road conditions and design vehicle used.

TYPICAL TYPE "A" MEDIAN BREAK FOR A 40 FT. DEPRESSED MEDIAN
 FOR USE AT INTERSECTIONS WITH ROADWAYS HAVING A CLASSIFICATION OF OTHER ARTERIAL OR HIGHER
 AND AT INTERSECTIONS WITH CONTINUOUSLY PAVED PUBLIC ROADS
 (A SPECIAL TRAFFIC STUDY IS REQUIRED TO JUSTIFY THIS TYPE OF MEDIAN BREAK AT OTHER LOCATIONS.)

Exhibit 4.28 Typical Type A Median Break (40 Foot Depressed Median)

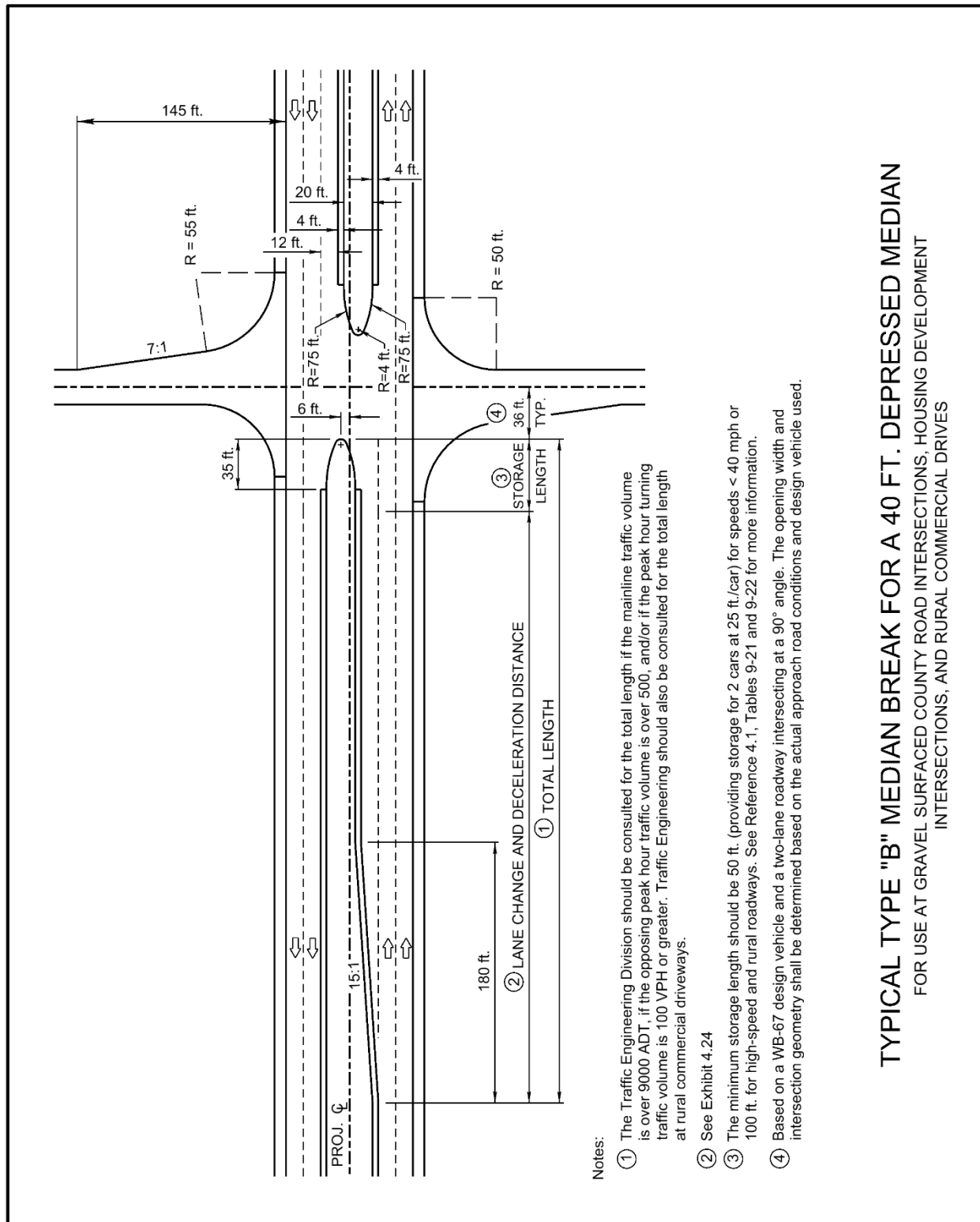

Notes:

- ① The Traffic Engineering Division should be consulted for the total length if the mainline traffic volume is over 9000 ADT, if the opposing peak hour traffic volume is over 500, and/or if the peak hour turning traffic volume is 100 VPH or greater. Traffic Engineering should also be consulted for the total length at rural commercial driveways.
- ② See Exhibit 4.24
- ③ The minimum storage length should be 50 ft. (providing storage for 2 cars at 25 ft./car) for speeds < 40 mph or 100 ft. for high-speed and rural roadways. See Reference 4.1, Tables 9-21 and 9-22 for more information.
- ④ Based on a WB-67 design vehicle and a two-lane roadway intersecting at a 90° angle. The opening width and intersection geometry shall be determined based on the actual approach road conditions and design vehicle used.

TYPICAL TYPE "B" MEDIAN BREAK FOR A 40 FT. DEPRESSED MEDIAN
 FOR USE AT GRAVEL SURFACED COUNTY ROAD INTERSECTIONS, HOUSING DEVELOPMENT
 INTERSECTIONS, AND RURAL COMMERCIAL DRIVES

Exhibit 4.29 Typical Type B Median Break (40 Foot Depressed Median)

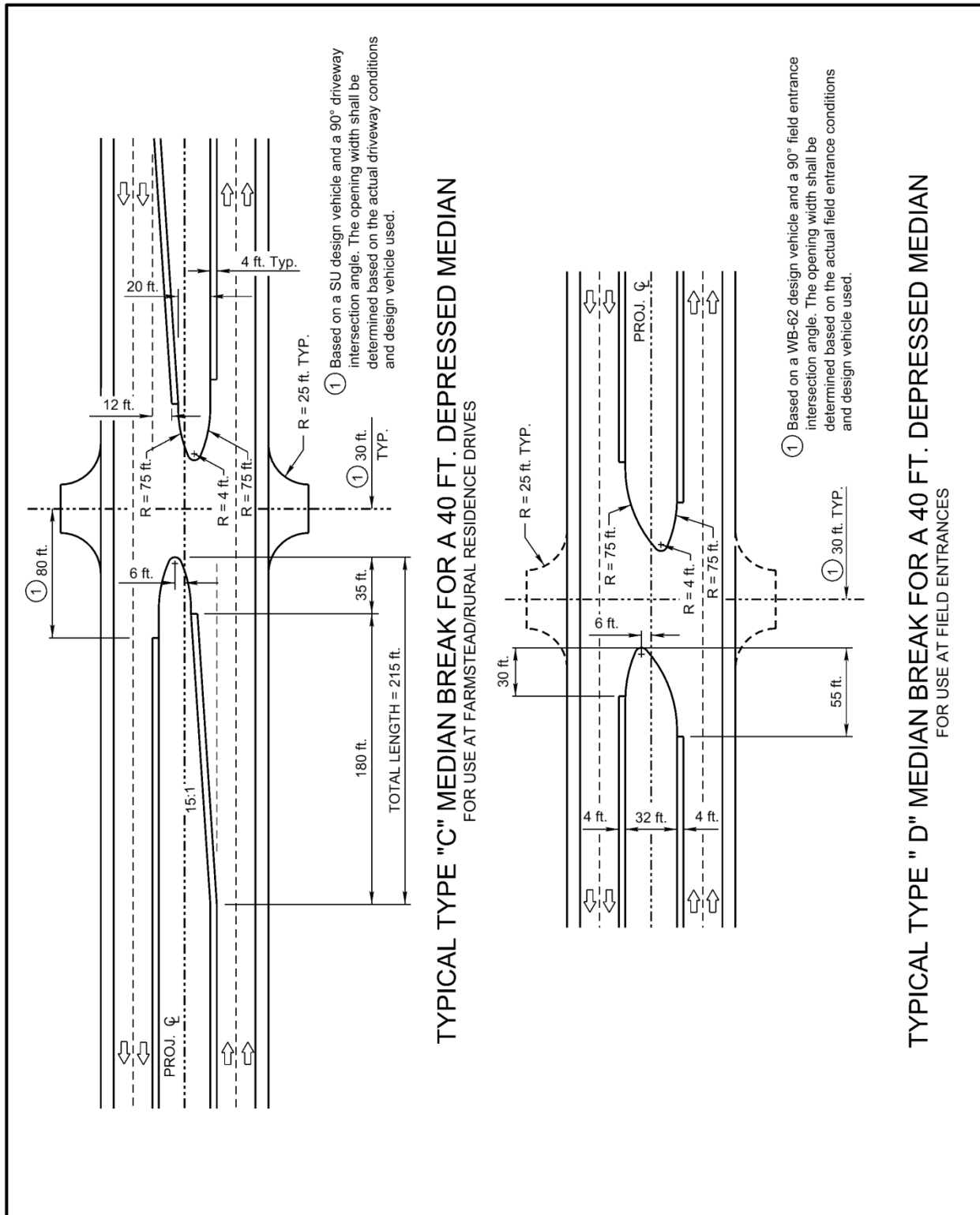

Exhibit 4.30 Typical Types C and D Median Breaks (40 Foot Depressed Median)

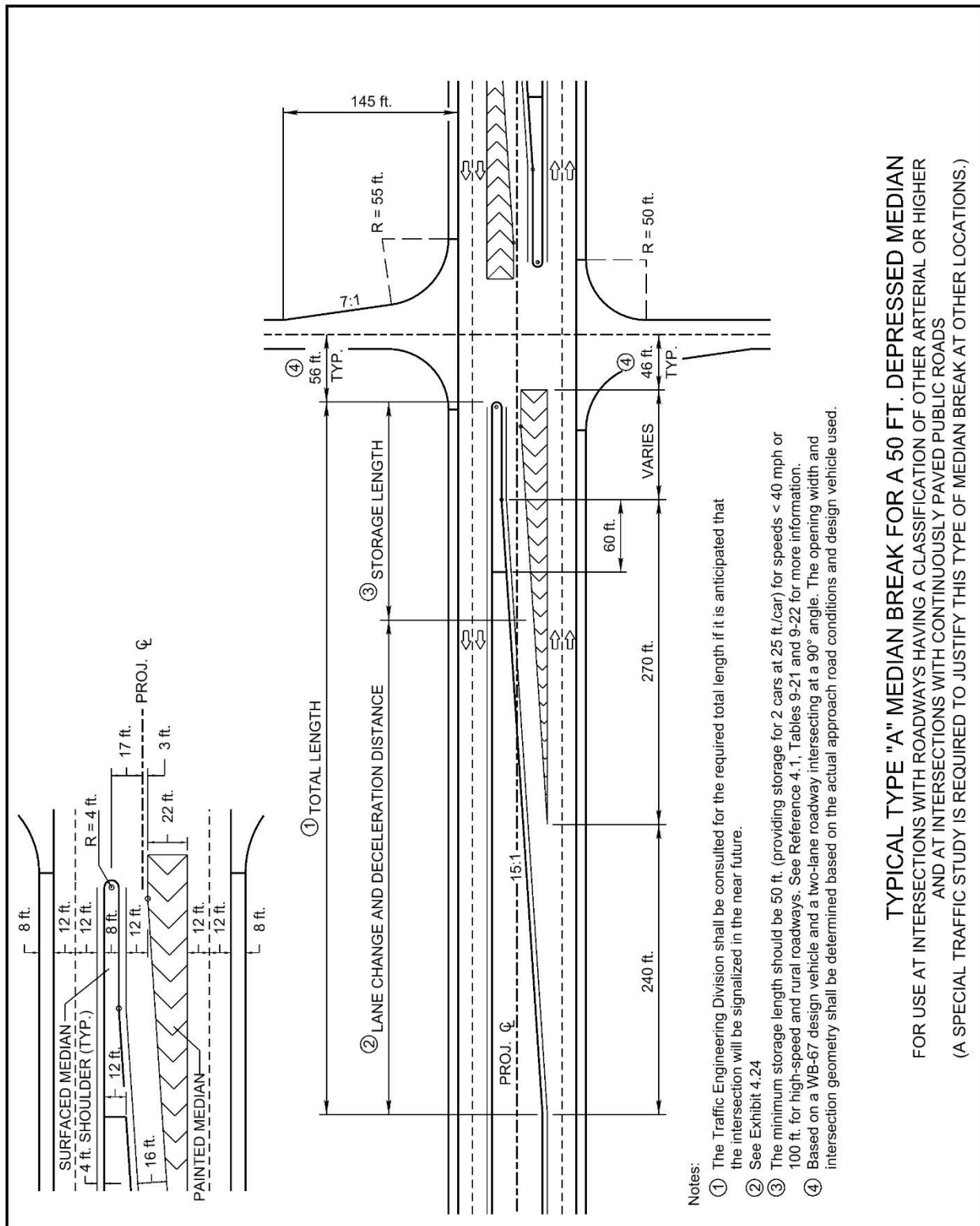
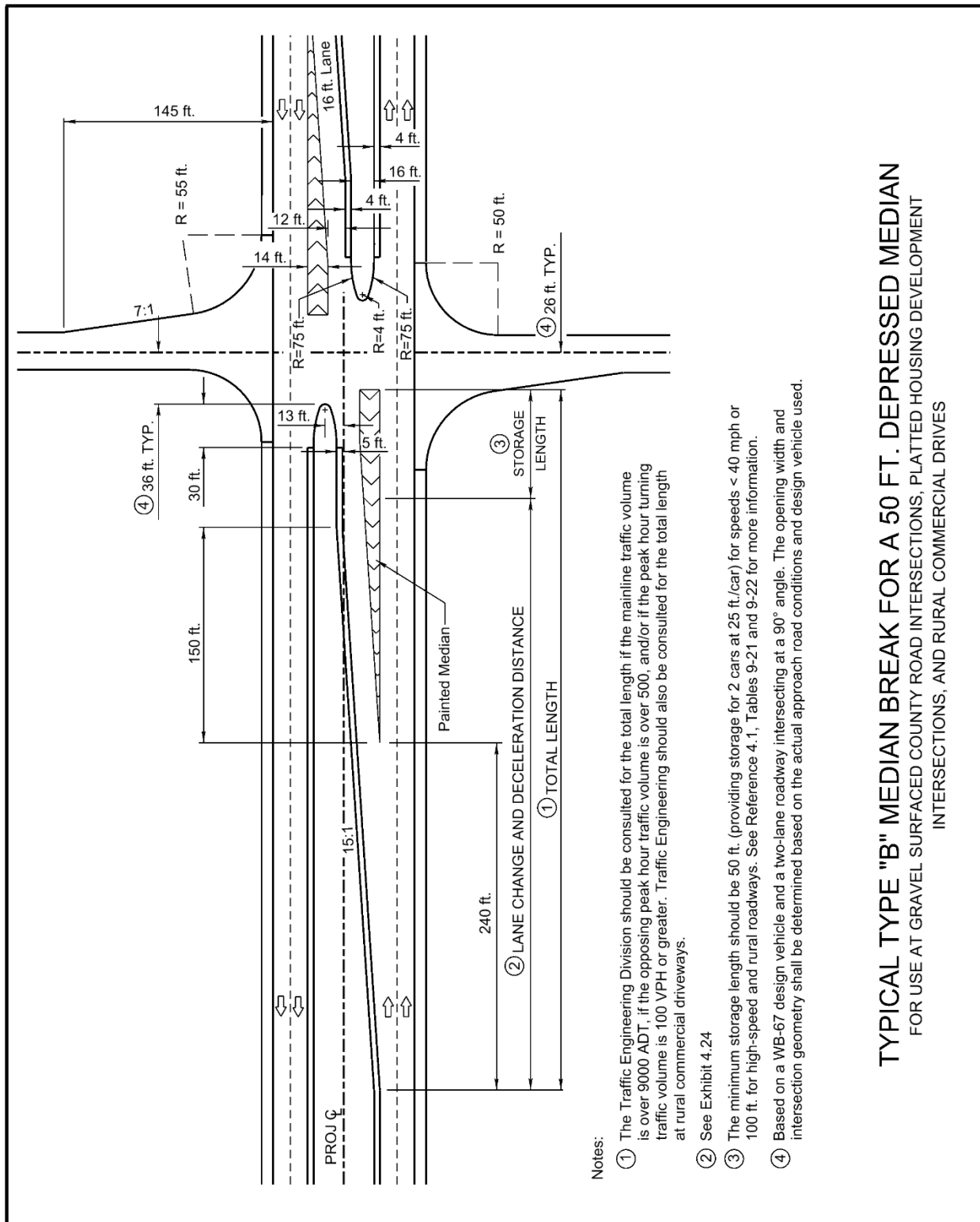

Exhibit 4.31 Typical Type A Median Break (50 Foot Depressed Median)



Notes:

- ① The Traffic Engineering Division should be consulted for the total length if the mainline traffic volume is over 9000 ADT, if the opposing peak hour traffic volume is over 500, and/or if the peak hour turning traffic volume is 100 VPH or greater. Traffic Engineering should also be consulted for the total length at rural commercial driveways.
- ② See Exhibit 4.24
- ③ The minimum storage length should be 50 ft. (providing storage for 2 cars at 25 ft./car) for speeds < 40 mph or 100 ft. for high-speed and rural roadways. See Reference 4.1, Tables 9-21 and 9-22 for more information.
- ④ Based on a WB-67 design vehicle and a two-lane roadway intersecting at a 90° angle. The opening width and intersection geometry shall be determined based on the actual approach road conditions and design vehicle used.

TYPICAL TYPE "B" MEDIAN BREAK FOR A 50 FT. DEPRESSED MEDIAN
 FOR USE AT GRAVEL SURFACED COUNTY ROAD INTERSECTIONS, PLATTED HOUSING DEVELOPMENT INTERSECTIONS, AND RURAL COMMERCIAL DRIVES

Exhibit 4.32 Typical Type B Median Break (50 Foot Depressed Median)

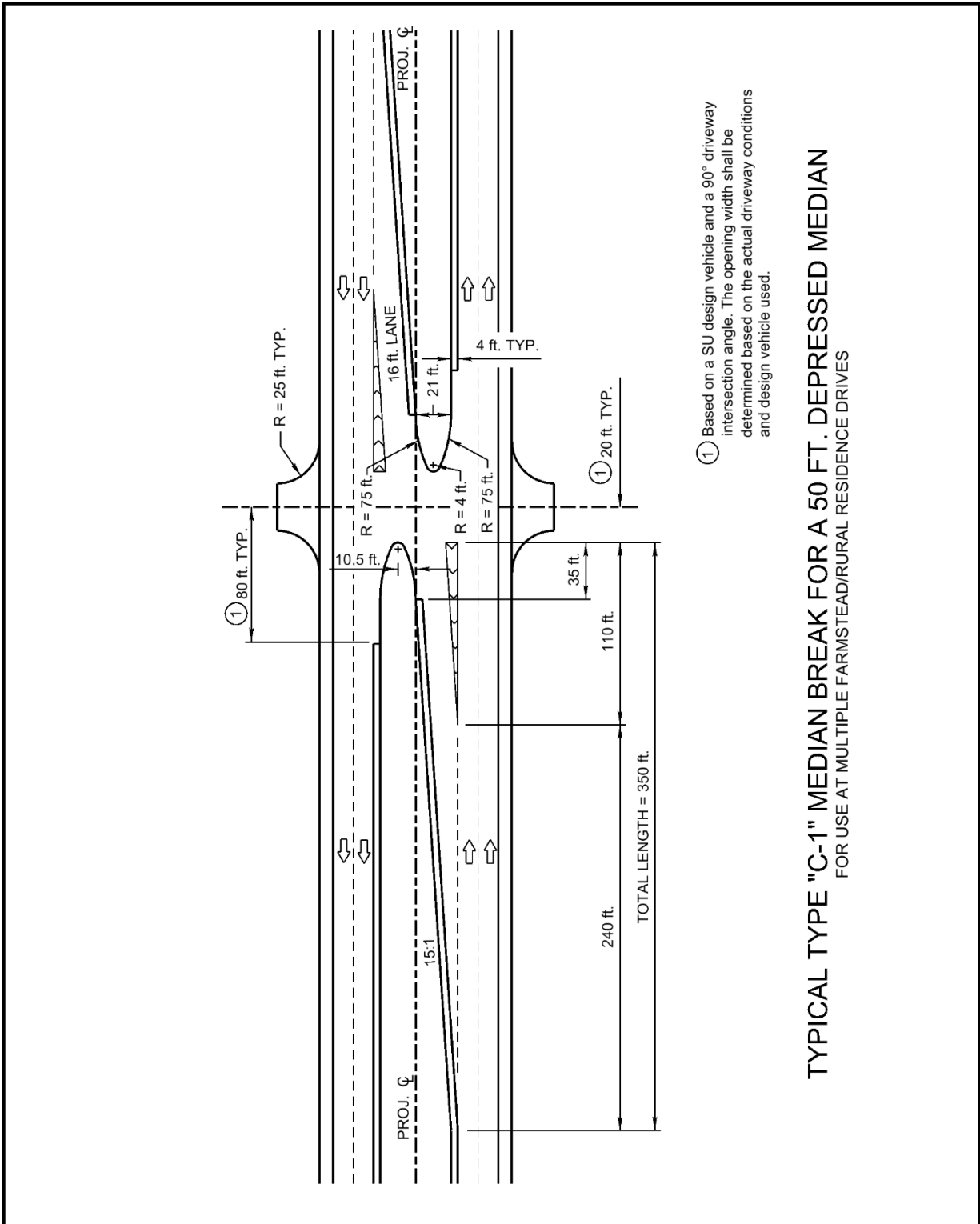

Exhibit 4.33 Typical Type C-1 Median Break (50 Foot Depressed Median)

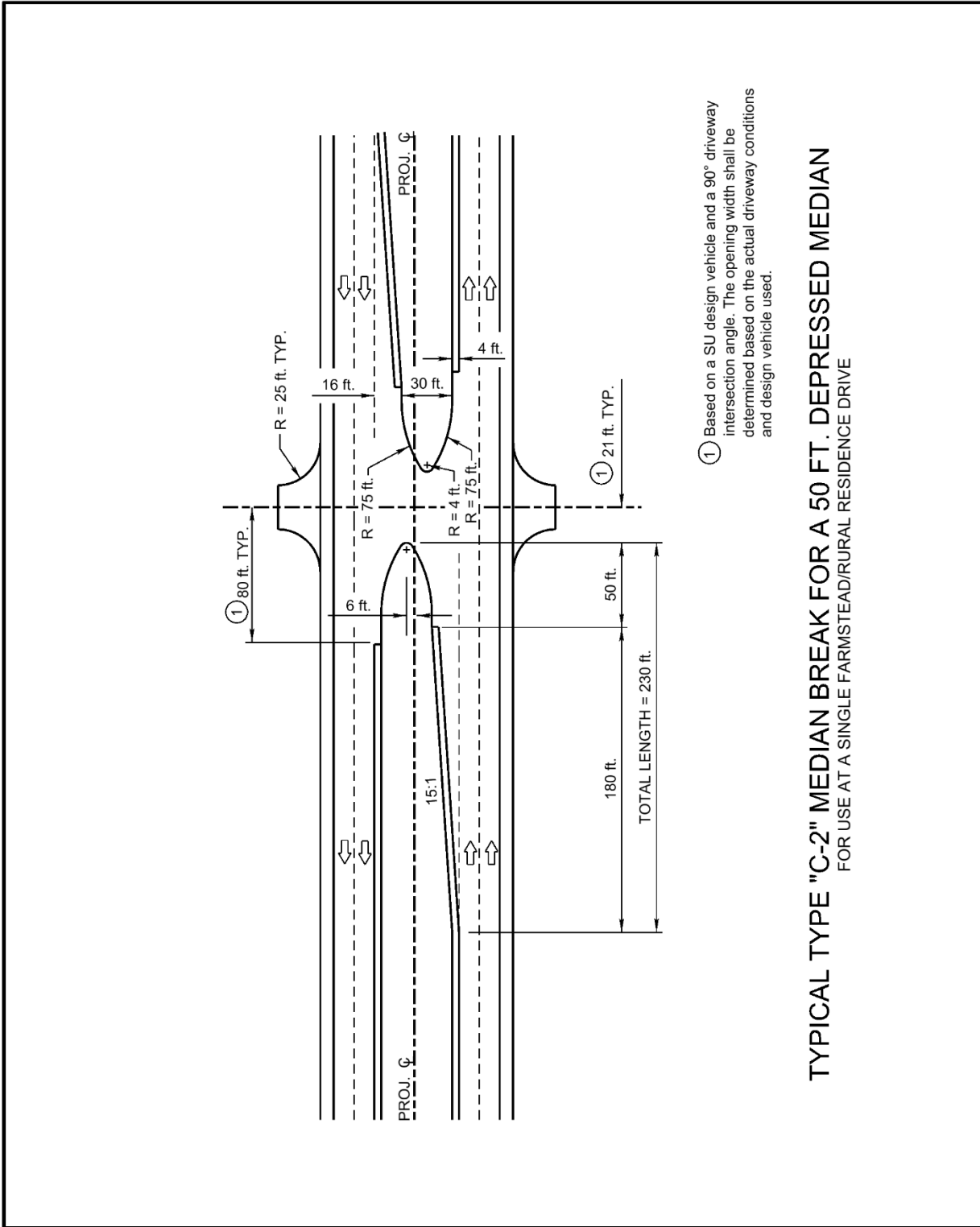

Exhibit 4.34 Typical Type C-2 Median Break (50 Foot Depressed Median)

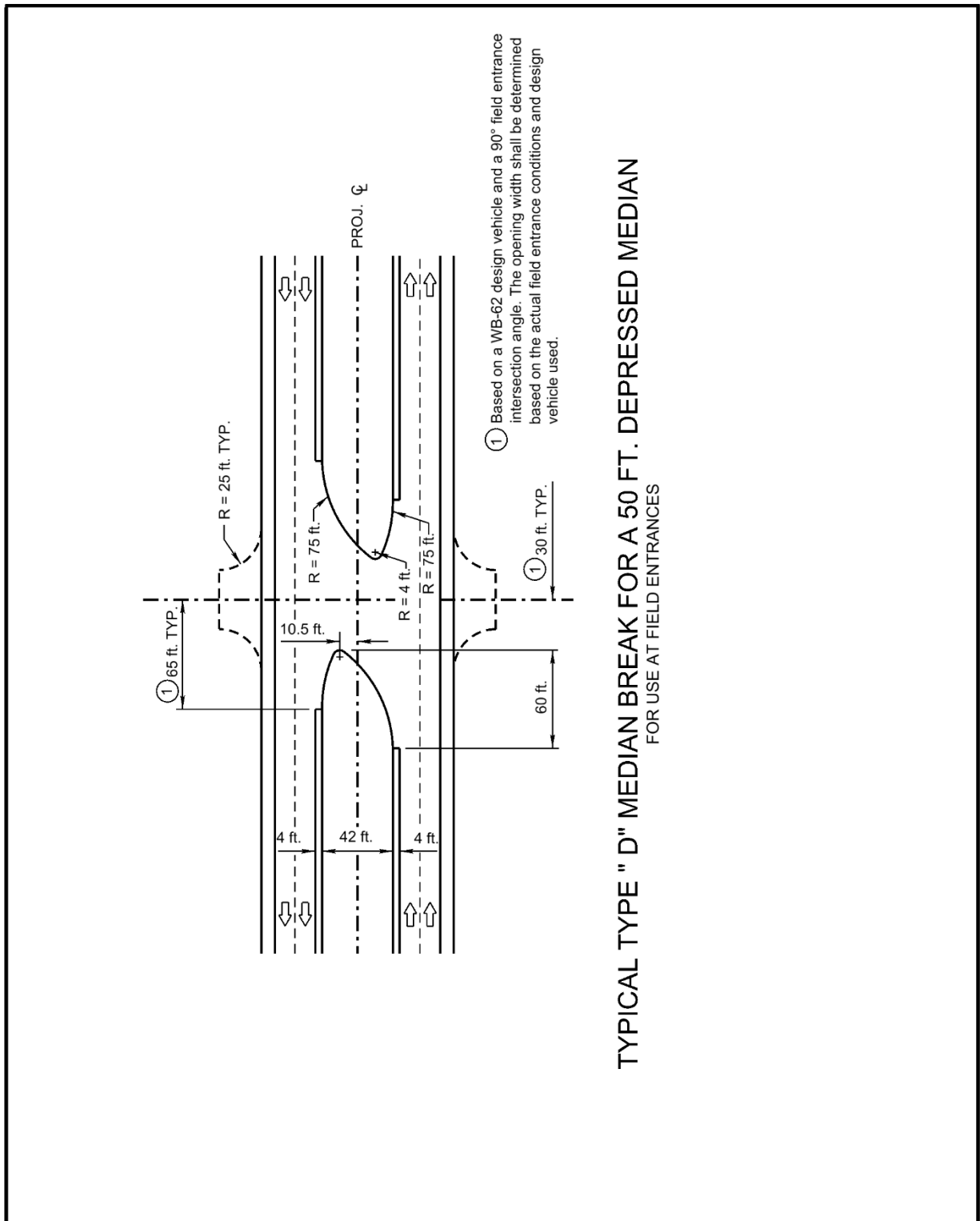

Exhibit 4.35 Typical Type D Median Break (50 Foot Depressed Median)

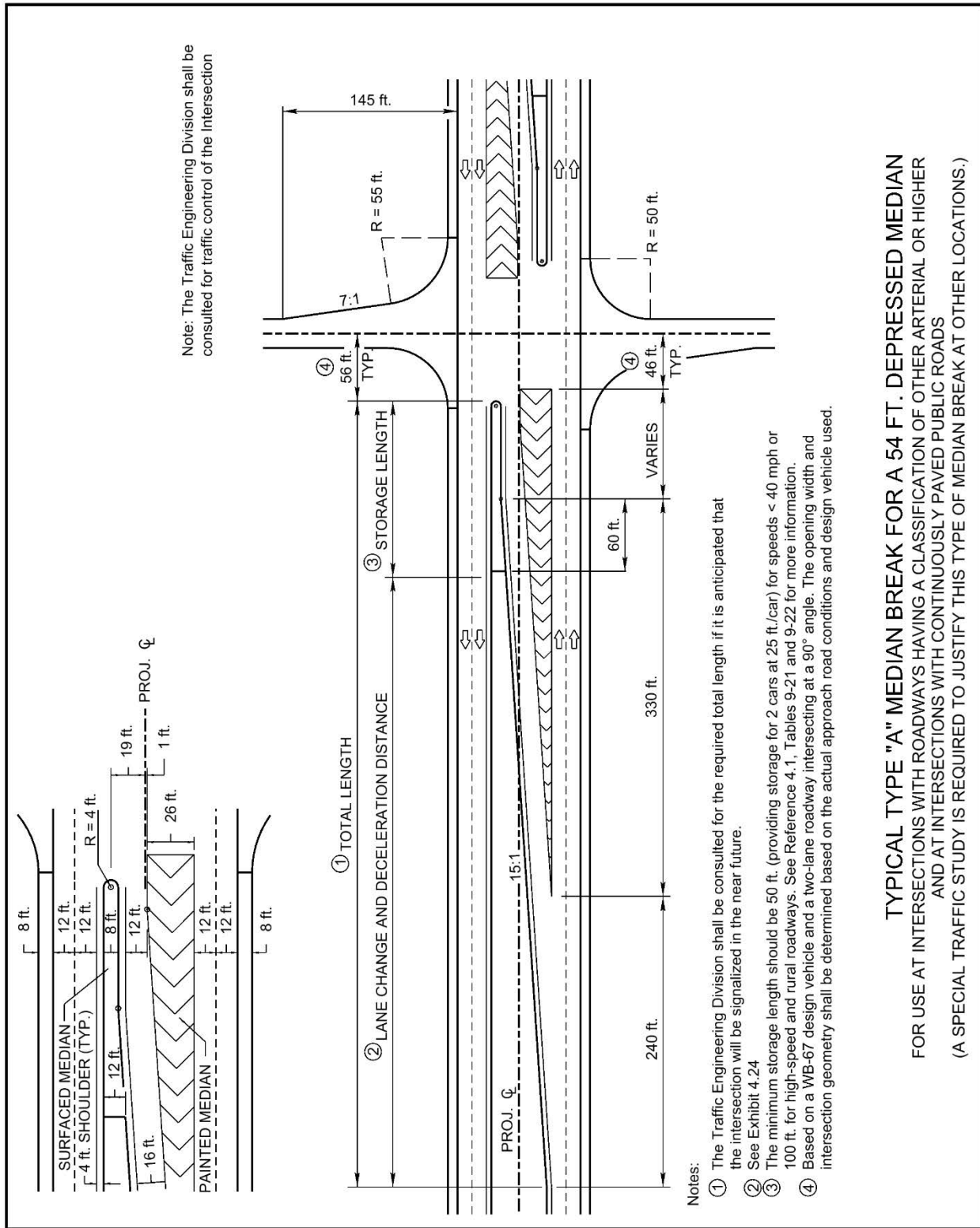
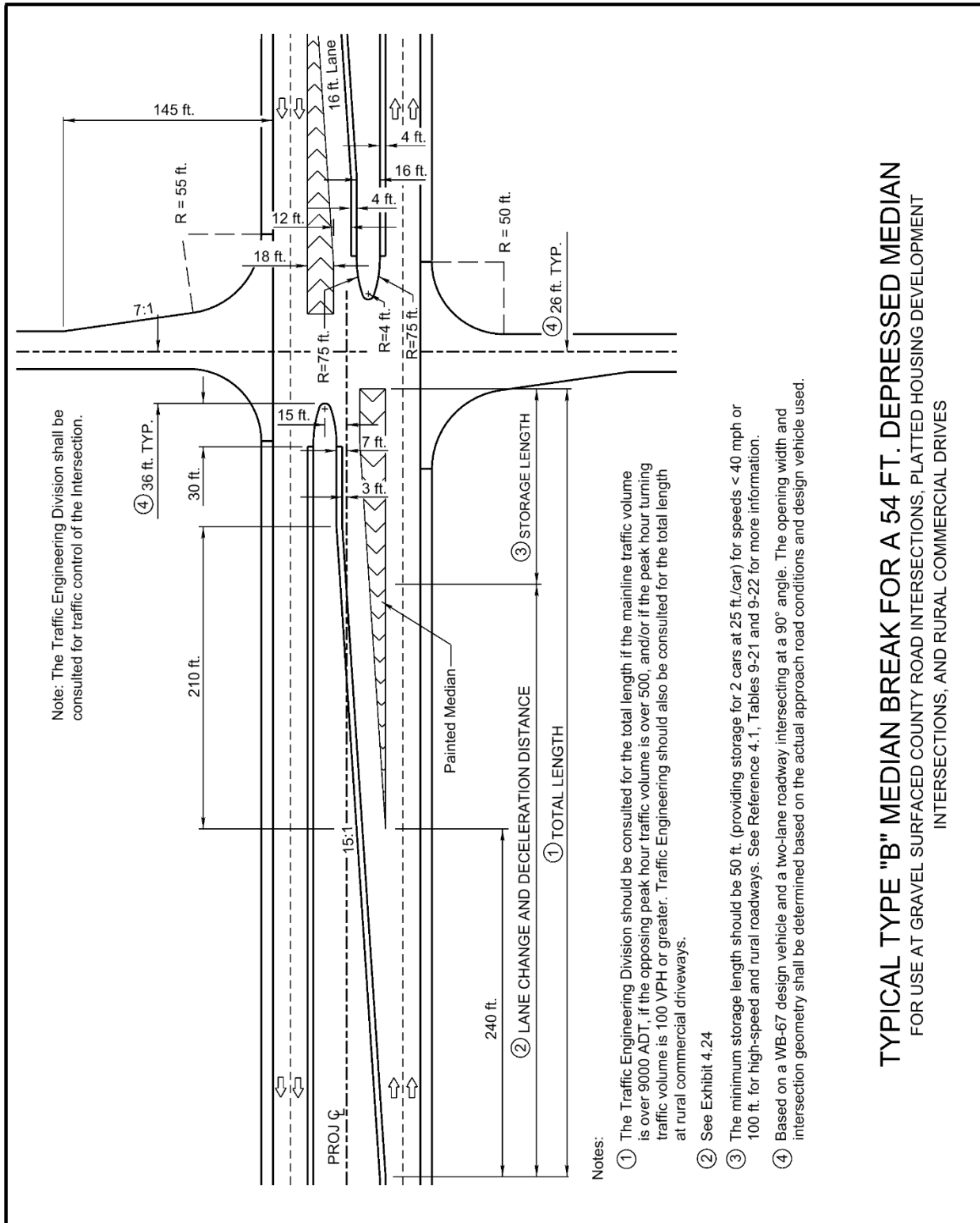

Exhibit 4.36 Typical Type A Median Break (54 Foot Depressed Median)



TYPICAL TYPE "B" MEDIAN BREAK FOR A 54 FT. DEPRESSED MEDIAN
 FOR USE AT GRAVEL SURFACED COUNTY ROAD INTERSECTIONS, PLATTED HOUSING DEVELOPMENT
 INTERSECTIONS, AND RURAL COMMERCIAL DRIVES

Exhibit 4.37 Typical Type B Median Break (54 Foot Depressed Median)

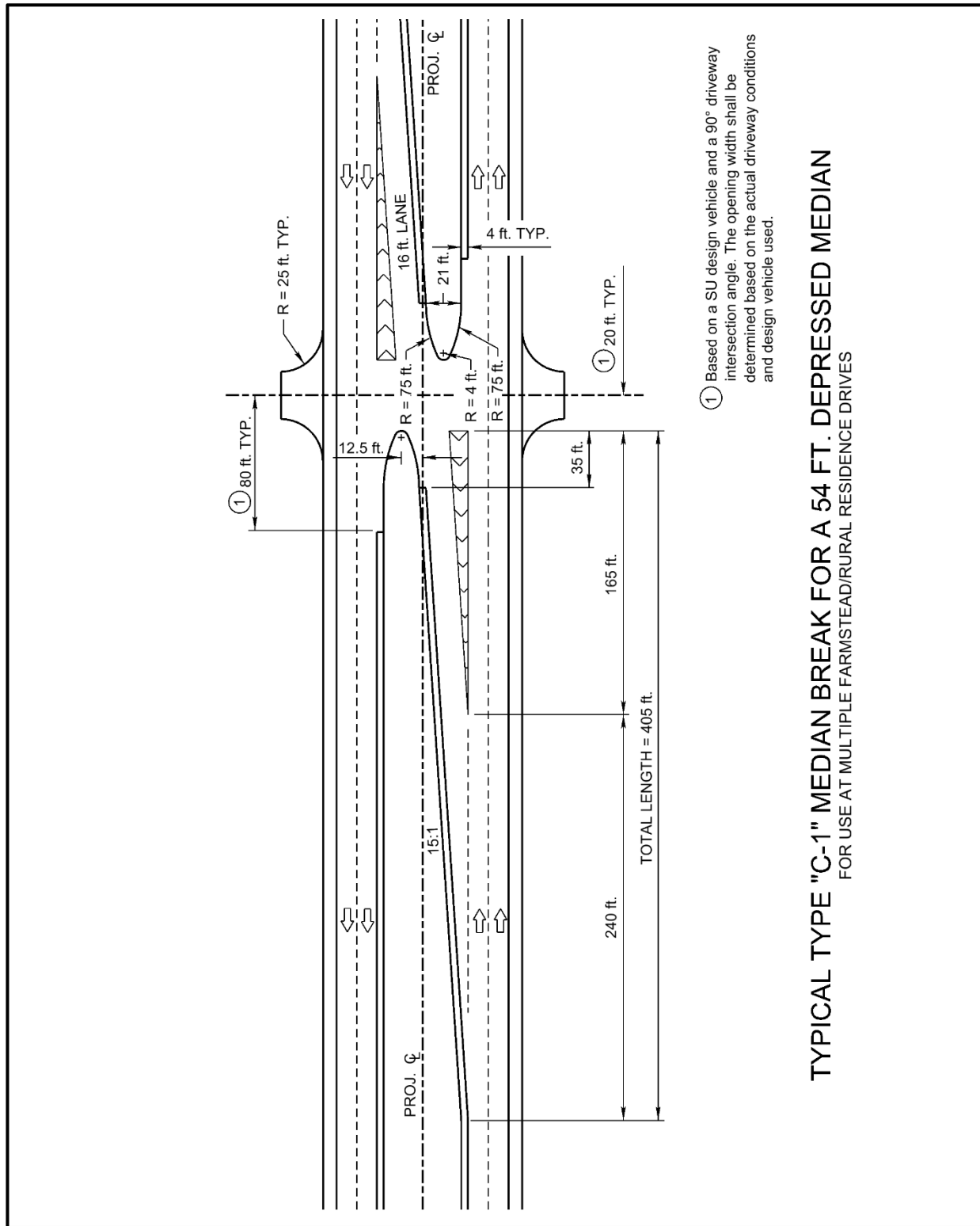

Exhibit 4.38 Typical Type C-1 Median Break (54 Foot Depressed Median)

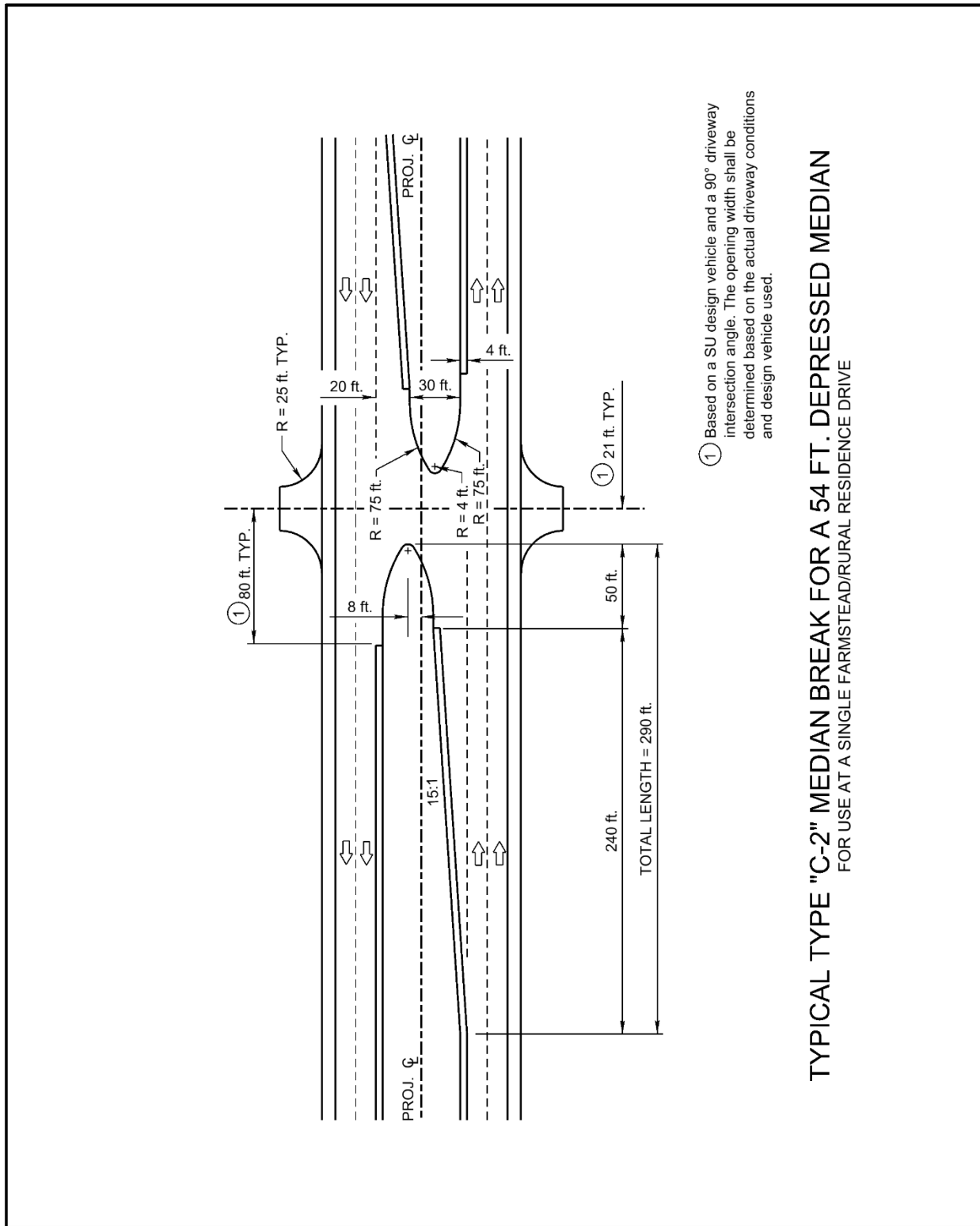

Exhibit 4.39 Typical Type C-2 Median Break (54 Foot Depressed Median)

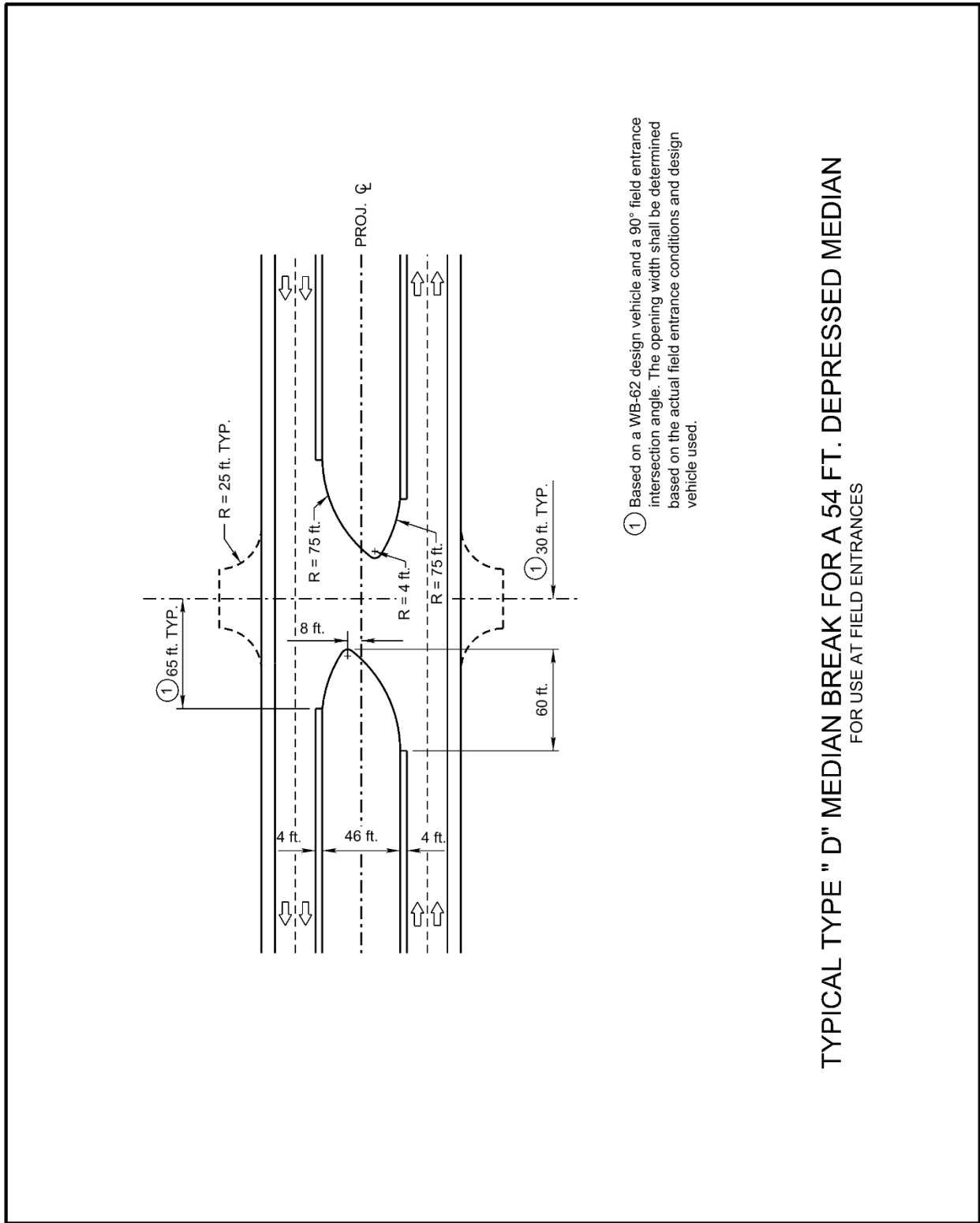

Exhibit 4.40 Typical Type D Median Break (54 Foot Depressed Median)

6. REFERENCES

- 4.1 American Association of State Highway and Transportation Officials, A Policy on Geometric Design of Highways and Streets (the *Green Book*), Washington, DC, 2018.
- 4.2 U.S. Department of Transportation, Federal Highway Administration, Manual on Uniform Traffic Control Devices for Streets and Highways (MUTCD), Washington, DC, 2009. (<http://www.roads.nebraska.gov/business-center/contractor/mutcd/>)
- 4.3 State of Nebraska, Supplement to the Manual on Uniform Traffic Control Devices (NE-MUTCD), 2011 (<http://www.roads.nebraska.gov/business-center/contractor/mutcd/>)
- 4.4 Schurr, Karen, et al, "Appropriate Design Speed for Horizontal Curves Approaching a Stop", NDOT Research Project Number SPR-PL-1(038) P534, University of Nebraska-Lincoln, September 2004
- 4.5 Transportation Research Board, "Impacts of Access Management Techniques", NCHRP Report 420, Washington, DC, 1999
- 4.6 Transportation Research Board, National Research Council, Highway Capacity Manual, Special Report 209, Washington, DC, Current Edition.
- 4.7 Board of Public Roads Classifications and Standards, Nebraska Minimum Design Standards (MDS), Current Edition. (<http://www.roads.nebraska.gov/media/5593/nac-428-rules-regs-nbcs.pdf>)
- 4.8 McCoy, Patrick, Eric Tripi and James Bonneson, "Guidelines for Realignment of Skewed Intersections," NDOT Research Project Number RES1 (0099) P471 Transportation Research Studies, University of Nebraska - Lincoln, June 1994.
- 4.9 Architectural and Transportation Compliance Board, Proposed Guidelines for Pedestrian Facilities in the Public Right-of-Way (With 2013 Supplement) (Proposed Guidelines (2013)), Washington, D.C., 2013 (<http://www.access-board.gov/guidelines-and-standards/streets-sidewalks/public-rights-of-way/proposed-rights-of-way-guidelines>)
- 4.10 American Association of State Highway and Transportation Officials, Guide for Development of Bicycle Facilities, Washington, DC, 1999. (http://safety.fhwa.dot.gov/ped_bike/docs/b_aashtobik.pdf)
- 4.11 McCoy, Patrick, et. al., "Guidelines for Free Right-Turn Lane at Unsignalized Intersections on Rural Two-Lane Highways," TRP-02-32, NDOT Research Project Number RES 1(0099) P603, University of Nebraska - Lincoln, March 1995.
- 4.12 Nebraska Department of Transportation, Access Control Policy to the State Highway System, June 1993. (<http://www.roads.nebraska.gov/media/3460/access-control-policy.pdf>)
- 4.13 American Association of State Highway and Transportation Officials, An Informational Guide for Preparing Private Driveway Regulations for Major Highways, Washington, DC, 1960.

- 4.14 Nebraska Department of Transportation, Standard/Special Plan Book (*Standard Plans*), Current Edition (<http://www.roads.nebraska.gov/business-center/design-consultant/stand-spec-manual/>)
- 4.15 Nebraska Department of Transportation, Drainage Design and Erosion Control Manual (*Drainage Manual*), Current Edition. (<http://www.roads.nebraska.gov/business-center/design-consultant/rd-manuals/>)
- 4.16 Nebraska Department of Transportation, Standard Specifications for Highway Construction (*Spec Book*), 2017. (<http://dot.nebraska.gov/media/10343/2017-specbook.pdf>)
- 4.17 Nebraska Department of Transportation, So You Want Access to the Highway?, Current Edition. (<http://www.roads.nebraska.gov/media/3462/access-hwy.pdf>)
- 4.18 Transportation Research Board, “Roundabouts: An Informational Guide – Second Edition”, NCHRP Report 672, Washington, DC, 2010 (http://onlinepubs.trb.org/onlinepubs/nchrp/nchrp_rpt_672.pdf)
- 4.19 Schurr, Karen, Foss, Timothy Jr., “Offset Right-Turn Lanes for Improved Intersection Sight Distance”, NDOT Research Project Number SPR-P1(06) P592, University of Nebraska-Lincoln, June 2010