

The information contained in Chapter Three: Stormwater Treatment, dated April 20, 2018 has been updated to reflect the August 2018 Errata. The errata addresses errors, changes in procedure, changes in NDOT department titles, changes in other Roadway Design and Drainage Manual chapters and other reference material citations occurring since the latest publication of this chapter.

This chapter replaces Chapter Three: Stormwater Treatment, dated September 2013. The Nebraska Division of the FHWA approved this chapter for use on the National Highway System and other federal projects on April 20, 2018.

CHAPTER THREE STORMWATER TREATMENT

WITHIN MUNICIPAL SEPARATE STORM SEWER SYSTEM (MS4) COMMUNITIES

This Chapter provides designers with the necessary guidance for incorporating Water Quality Stormwater Treatment Facilities (STF) into Nebraska Department of Transportation (**NDOT**) projects. Specifically, this chapter details the selection, placement and design of STFs.

Stormwater Treatment policies, procedures and guidelines are subject to amendment as conditions warrant. They are not intended to be nor do they establish legal standards. Special situations may call for variations from these requirements, subject to approval from the **Roadway Design Unit Head (Unit Head)** or **Assistant Design Engineer (ADE)**. The proper documentation of drainage decisions is important for the purposes of project records and archiving.

SELECTED DEFINITIONS (See the Glossary for additional information)

De minimis - De minimis means “of minimum importance”. It refers to something that is so small or trivial that law does not consider it and is often used to describe exemptions in government rules and regulations.

Ephemeral Stream - A stream that flows only during and immediately after precipitation events.

Impervious Surface - A hard surface area that prevents or retards the entry of water into the soil.

Intermittent Stream - An intermittent or seasonal stream is one that has a consistent base flow, but only for part of the year.

Land Disturbance - Areas of exposed, erodible soil, including stockpiles, that are within the limits of construction and that result from construction activities.

Linear Facility – A roadway.

MS4 Community - An Urbanized Area with a population of 10,000 or greater and a population density of at least 1,000 people/square mile (See Appendix O).

MS4 Permit - An MS4 Permit (NPDES Permit) is EPA's program to control the discharge of pollutants to waters of the United States.

New Pavement - New Pavement is defined as an impervious surface which is placed in an area currently devoid of such surfacing, or the complete removal and replacement of existing surfacing with modification of the base and/or subgrade.

Non-Linear Facilities - Rest Areas, Maintenance Yard, Offices, etc.

Perennial Stream – A stream or river (channel) that has continuous flow in parts of its bed all year round during years of normal rainfall.

Receiving Water - Creeks, streams, rivers, lakes, estuaries, or other surface water bodies into which stormwater is discharged.

Stormwater Treatment Facility (STF) - A STF is a measure that is implemented to protect water quality and reduce potential for pollution associated with stormwater runoff.

Total Suspended Solids (TSS) - TSS is the weight of particles that are suspended in water.

Wetland - Areas that are inundated or saturated by surface or ground water at a frequency or duration sufficient to support, and that under normal circumstances do support, a prevalence of vegetation typically adapted for life in saturated soil conditions. Wetlands generally include swamps, marshes, bogs and similar areas.

ACRONYMS AND ABBREVIATIONS

3R	Resurfacing, Restoration, and Rehabilitation
ADE	Assistant Design Engineer in the Roadway Design Division
CN	Curve Number
DPO	Design Process Outline
EPA	Environmental Protection Agency
Form A	Stormwater Treatment within MS4 Communities / Form A – Project Evaluation (See Appendix L)
Form B	Stormwater Treatment within MS4 Communities / Form B – STFs (See Appendix M)
Form C	Stormwater Treatment within MS4 Communities / Form C – Maintenance (See Appendix Q)
LPA	Local Public Agency
MS4	Municipal Separate Storm Sewer System
NDEQ	Nebraska Department of Environmental Quality
NDOT	Nebraska Department of Transportation
NPDES	National Pollutant Discharge Elimination System
NRCS	Natural Resources Conservation Service
PDD	Project Development Division
ROW	Right-of-Way
RDC	Roadside Development & Compliance Unit in PDD
STF	Stormwater Treatment Facility
T_c	Time of Concentration
TMDL	Total Maximum Daily Loads
TSS	Total Suspended Solids
Unit Head	Roadway Design Unit Head
WQV	Water Quality Volume

1. STORMWATER TREATMENT OBJECTIVE

Stormwater Treatment is a condition of **NDOT's** Municipal Separate Storm Sewer System (MS4) permit. The objective of stormwater treatment is to minimize the discharge of potential pollutants in the highway's post project stormwater runoff to waters of the state. The **NDOT** will accomplish this objective by evaluating projects and implementing stormwater STFs where appropriate.

STFs are a combination of permanent structural and/or non-structural best management practices (STFs) used to improve stormwater quality throughout the functional life of the roadway. Structural STFs include practices that remove pollutants from stormwater runoff by the settling of particulate matter, filtration, biological uptake, and soil adsorption. Examples include:

- Storage practices such as extended-detention ponds
- Filtration practices such as filter strips
- Grassed swales
- Bio-retention
- Sand filters and
- Infiltration practices such as infiltration basins and infiltration trenches

Non-structural measures are typically source control measures designed to reduce the level of contaminants before they are carried away in stormwater runoff. Examples include:

- Policies and ordinances that provide requirements and standards to direct growth to identified areas
- Protection of sensitive areas such as wetlands and riparian areas
- Maintaining and/or increasing open spaces
- Providing buffers along sensitive water bodies
- Minimize impervious surfaces, and
- Minimizing disturbance of soils and vegetation

2. LEGAL AND REGULATORY

2.A Municipal Separate Storm Sewer System (MS4) Permit

The **NDOT** is a regulated MS4 and is required to meet the conditions of its National Pollutant Discharge Elimination System (NPDES) MS4 permit. This permit is administered by the **Nebraska Department of Environmental Quality (NDEQ)** and requires the **NDOT** to:

- Develop and implement strategies which include a combination of structural and/or non-structural STFs
- Have a policy requiring the implementation of STFs to the extent allowable under State, Tribal or local law
- Ensure adequate long-term operation and maintenance of STFs

2.A.1 Local Public Agencies

A **Local Public Agency (LPA)** permitted as a MS4 operates under its own NPDES permit. Therefore the requirement to establish stormwater treatment controls is guided by that specific permit and is subject to review only by the **NDEQ** and the **Environment Protection Agency (EPA)**. The **NDOT's** stormwater treatment program does not supersede a **LPA's** stormwater treatment program or act as a minimum standard, except when a **LPA** project is being constructed on a State or Federal Highway located within a MS4 community. In those instances, the **LPA** may utilize its own program as long as it meets the minimum requirements established in this Chapter. For additional information on **LPA** projects, contact the **Local Projects Section** of the **Materials and Research Division** of the **NDOT**.

2.B Total Maximum Daily Loads (TMDLs)

Under section 303(d) of the Clean Water Act (<http://www.thecre.com/fedlaw/legal14water/cwa.htm>), the **NDEQ** is required to compile a list of impaired waters that fail to meet the applicable water quality standards or cannot support their designated or existing uses. This list, known as the “303(d) list,” is submitted to the **EPA** every two years. The **NDEQ** may then develop a TMDL for pollutants causing impairment of a water body on the list. Included within the TMDL is a treatment standard that is designed to reduce the level of the restricted pollutants to which all entities discharging into the stream must adhere.

Highways that have stormwater outfalls discharging into receiving waters for which TMDLs or other water quality requirements have been established may be subject to additional water quality treatment requirements. In addition, receiving water bodies that have a treatment standard based on TMDLs may require more stringent analysis and treatment regimens. Therefore, it is important to recognize all treatment requirements when designing projects. Additional information on the TMDL program and 303(d) list is provided on the **NDEQ** Website: (<http://deq.ne.gov/NDEQProg.nsf/%24%24OpenDominoDocument.xsp?documentId=E238CC319E38A69386257CB500746DCD&action=openDocument>).

The **Roadside Development & Compliance Unit (RDC)** in the **Project Development Division (PDD)** will notify project designers of any potential TMDLs after its Roadside Development Coordination review. This review is completed during the “Scoping Phase” (See the Design Process Outline (DPO), Ref. 3.1), and will be documented on the “Stormwater Treatment within MS4 Communities / Form A - Project Evaluation” (Form A), included in Appendix L. Form A will be the primary document to evaluate projects for STFs and other water quality requirements.

Form A is initiated by **RDC** who places it on OnBase, and will be finalized by the designer prior to the “Plan in Hand Phase” (See the DPO, Ref. 3.1). It is important that this form and other forms included in this chapter are completed and maintained with the project file.

2.B.1 Total Maximum Daily Loads (TMDLs) or Other Water Quality Requirements

Treatment must be provided within a TMDL watershed when discharging into receiving waters for which TMDLs or other water quality requirements have been established, and **NDOT** has been named as a contributor and assigned a Waste Load Allocation. An evaluation of the TMDLs or other water quality requirements will occur during Preliminary Project Evaluation on Form A.

2.C Platte River Depletion

In 2006, the **State of Nebraska** signed an agreement and enacted legislation to restrict water use in the Platte River basin in an effort to comply with the Endangered Species Act (<http://www.fws.gov/laws/lawsdigest/esact.html>). The goals of the restrictions are to reduce shortages, to target flows in the central Platte River, and to obtain and restore critical habitat for the “target species” (whooping crane, interior least tern, piping plover, and pallid sturgeon).

Stormwater treatment activities conducted within the regulated area may be subject to restrictions if they constitute new surface water or hydrologically connected groundwater actions which may affect the quantity or timing of water reaching the associated habitats of the target species. Two examples of such activities would be those that expose the groundwater table to the atmosphere and those that will impound water such as ponds and wetlands. If a project is being constructed within this regulated area, **RDC** will notify the designer during the Project Evaluation Process detailed in Section 3. Additional information on this program can be obtained by contacting the **Environmental Documents Unit** in **PDD**.

2.C.1 *De Minimis* Threshold for Platte River Species Depletions Consultations

The **U.S. Fish and Wildlife Service** has adopted a policy that water-related activities in the Platte River basin resulting in less than 0.1 acre-foot/year of depletions in flow to the nearest surface water tributary to the Platte River system do not affect the Platte River target species, and thus do not require consultation with the **U.S. Fish and Wildlife Service** for potential effects on those species.

Similarly, detention basins designed to detain runoff for less than 72 hours and temporary withdrawals of water (e.g., for hydrostatic pipeline testing) that return all the water to the same drainage basin within 30 days' time are considered to have no effect, and may not require consultation.

A *de minimis* determination is made only by the **Environmental Documents Unit** in **PDD**.

2.D Legal, Regulatory and Environmental Issues Related to Drainage

Many of the legal, regulatory and environmental issues identified in Chapter One: Drainage also pertain to activities completed in this Chapter. The designer should familiarize him/herself with the corresponding section in Chapter One.

2.E Designation of STFs

STFs are engineered stormwater treatment facilities and will be designated as such on both Design and ROW Plans. Many of these measures will capture and hold water for some period of time and may develop wetland characteristics. This could occur naturally or as a designed feature of the STF. Regular maintenance activities, changes to the STF design and/or relocation of the facility due to future construction may occur at any time at the discretion of the **NDOT** (See Sections 7.A.6.a, “Retention of ROW for STF” and 8.D, “Plan Labeling of STF”).

3. **PROJECT EVALUATION PROCESS**

This section provides guidance to evaluate a project for STFs. The entire process, outlined in this chapter, is graphically represented in EXHIBITS 3.1, 3.2 & 3.3.

A preliminary project evaluation will be completed for every project by **RDC** using the project criteria provided in Section 3.B. After receiving the preliminary project evaluation, the designer will complete a final project evaluation to determine if the project requires STFs. Coordination between **RDC** and **Roadway Design** will occur several times throughout the project schedule, as determined by the **Unit Head**, to address the stormwater treatment requirements. Specifically, this will occur at the “Environmental Coordination Meetings” (See **EXHIBIT A** of the DPO, Ref. 3.1) but communication can and should occur as needed throughout the project design. To document this process, Form A will be used.

3.A General Project Criteria

When all three criteria outlined below are met, the project must be evaluated for STFs.

1. Project Location – The project is located within or partly within the boundary of a regulated MS4 Community in Nebraska. See Appendix O for a list of regulated MS4s in Nebraska.
2. Project Size – The project results in a land disturbance ≥ 1 acre (including projects that disturb < 1 acre if part of a common plan of development).
3. Project Nature – The project is classified as a Resurfacing, Restoration and Rehabilitation (3R) project with a net increase of at least 5,000 square feet of New Pavement, or as a New and Reconstruction project.

New Pavement is defined as an impervious surface (a hard surface area that prevents or retards the entry of water into the soil, thus causing water to run off the surface in greater quantities and at an increased rate of flow) which is placed in an area currently devoid of such surfacing, or the complete removal and replacement of existing surfacing with modification of the base and/or subgrade.

3.A.1 3R and New and Reconstruction Projects

Stormwater treatment is not required unless a project meets the project nature criteria for 3R and New and Reconstruction as stated below.

- 3R projects must result in a net increase of at least 5,000 square feet of New Pavement. This includes, but is not limited to, adding turn lanes, paving shoulders, trench widening, driveways, sidewalks, and side streets. This also includes redevelopment work completed for non-linear facilities such as maintenance yards and rest areas that result in the net increase of at least 5,000 square feet of New Pavement.
- New and Reconstruction projects must result in the placement of New Pavement or Building(s). This also includes the development of new non-linear facilities such as maintenance yards and rest areas.

3.B Preliminary Project Evaluation

During the “Scoping Phase” (See the DPO, Ref. 3.1), **RDC** will complete a Preliminary Project Evaluation and will document this review in Clarity, Environmental Sub-Object Section for each project. If it is determined that an evaluation for STFs is not required for the project, the process will stop and no further consideration will be required. If the Preliminary Project Evaluation determines further review is needed, **RDC** will initiate Form A and will place the file on OnBase. A copy will also be forwarded to the roadway designer for a Final Project Evaluation as discussed in Section 3.C.

RDC will utilize the following criteria when completing the Preliminary Project Evaluation:

- **Are there TMDLs or other water quality requirements within project limits?**
Construction projects that discharge into a receiving water for which a TMDL or other water quality requirement has been established may be subject to additional water quality regulations such as the Platte River Depletion Implementation Program.
- **Is the project within an MS4 area?**
Projects and activities within MS4 areas may require the incorporation of STFs. Projects that cross a MS4 boundary may require STFs beyond the MS4 area where factors justify their use, such as watershed drainage, land use, etc.
- **Does the project disturb ≥ 1 acre of soil.**
Any project that results in a land disturbance equal to or greater than 1 acre. Land disturbance includes any areas where the bare soil will be exposed to weather for any period of time. The one (1) acre value is compared to the cumulative total of exposed soil.
 - **Is the project part of a Common Plan of Development?**
Projects that disturb less than 1 acre and are part of a larger Common Plan of Development whose total land disturbance activities are 1 acre or more are considered to meet the ≥ 1 acre disturbance criteria. In addition, the **DEQ** can designate projects as part of a common plan of development.
- **Is the project classified as 3R with ≥ 5000 sq. ft. of New Pavement or as New and Reconstruction?**
Stormwater treatment may be required for 3R projects (with at least 5,000 square feet of New Pavement) and New and Reconstruction projects (where New Pavement or Building(s) are placed in areas currently devoid of such surfacing or which completely remove and replace existing pavement).

3.C Final Project Evaluation

If the Preliminary Project Evaluation determines that STFs are to be determined, the designer will perform a Final Project Evaluation of the project and shall complete the corresponding section of Form A. This should be completed early enough in the “Plan-In-Hand Phase” (See the DPO, Ref. 3.1) that conceptual STF designs can be completed and placed within the Plan-In-Hand plans. Upon completion of the Final Project Evaluation, the designer will forward Form A to his/her **Unit Head** with a recommendation for or against STFs in the project. The **Unit Head** will be responsible for reviewing the recommendation and signing off on the form. The Final Project Evaluation will consider the following items:

- **Is this project classified as 3R and has \geq 5000 sq. ft. of New Pavement?**
3R projects that result in the net increase of at least 5,000 square feet of New Pavement require assessment for stormwater treatment needs. Projects redeveloping non-linear facilities such as maintenance yards and rest areas which result in the net increase of at least 5,000 square feet of New Pavement or building(s) also require assessment.
- **Does the project disturb \geq 1 acre of soil.**
Any project which results in a land disturbance of equal to or greater than 1 acre. Land disturbance includes any areas where the bare soil will be exposed to weather for any period of time. The 1 acre value is compared to the cumulative total of exposed soil.
 - **Is the project part of a Common Plan of Development?**
Projects that disturb less than 1 acre and are part of a larger Common Plan of Development whose total land disturbance activities are 1 acre or more are considered to meet the \geq 1 acre disturbance criteria. In addition, the **DEQ** can designate projects as part of a common plan of development.

Upon completion of his/her review, the **Unit Head** will forward a copy of the signed Form A to **RDC** and return the original to the designer. If STFs are not required to be considered for the project, the form will be closed out and placed in the project file. If STFs need to be considered for the project, the designer shall complete the “Stormwater Treatment within MS4 Communities / Form B - STF” (Form B), included in Appendix M. Form B will be used to document the design decisions made under Section 4, “Stormwater Treatment Facility Design Process”, of this Chapter.

3.D RDC Coordination with Adjacent MS4 Community

RDC will contact the adjacent MS4 Community as part of the preliminary project evaluation during the scoping phase, notifying them of the potential for STFs on the highway project. This contact will also be used to query the MS4 Community concerning preferences in STFs. Information provided to **RDC** by the MS4 Community will be provided to the designer on Form A.

3.E Change in Project Scope

A change in project scope that affects one or more of the criteria or considerations in Sections 3.A. and 3.B. requires a re-evaluation of the project for STFs. The designer must contact the **RDC Highway Environmental Program Manager** as soon as possible. A re-evaluation will be completed by **RDC** and **Roadway Design** and Form A will be updated to reflect any changes.

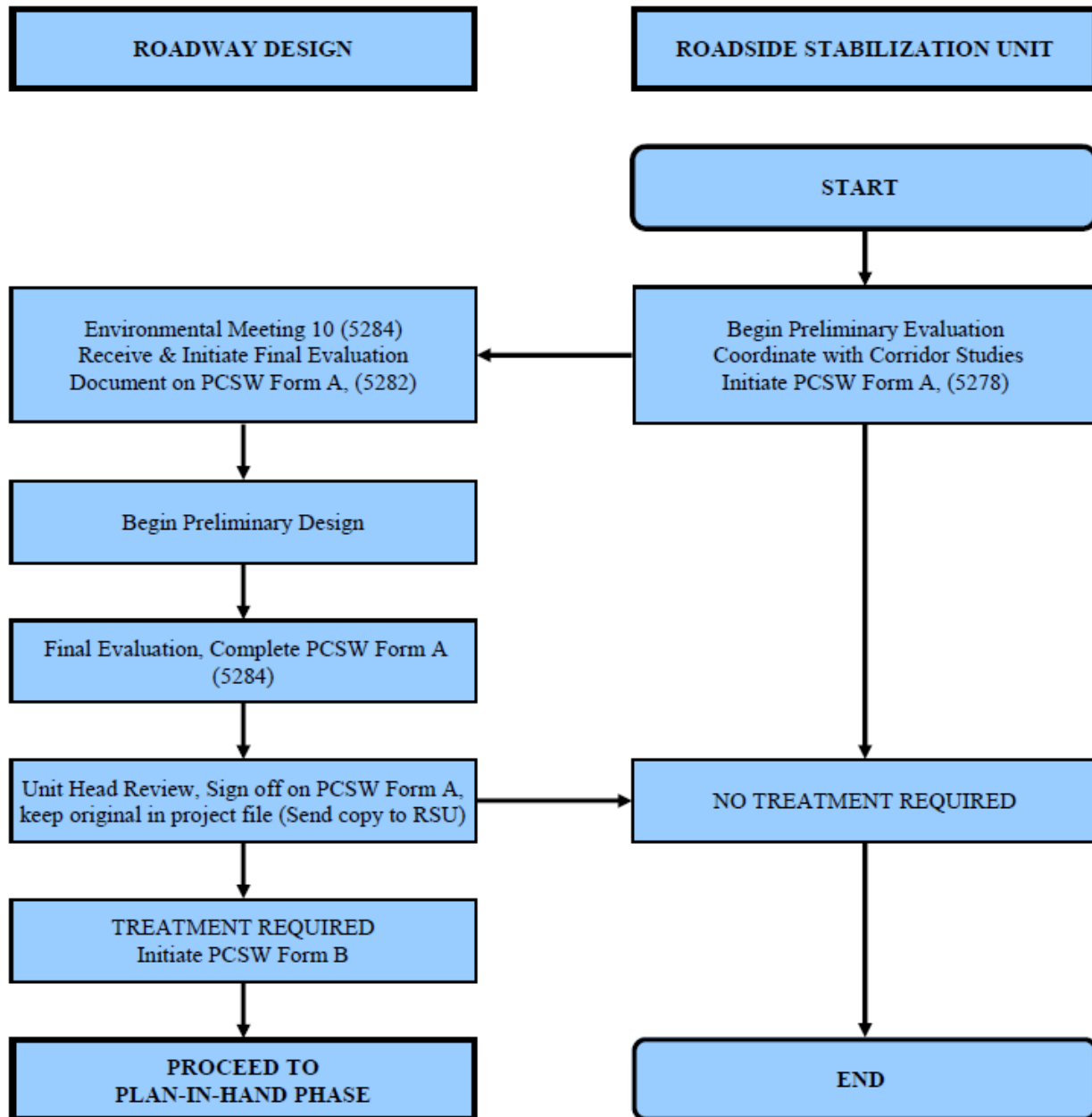

Exhibit 3.1: Stormwater Treatment Process Chart for Scoping Phase

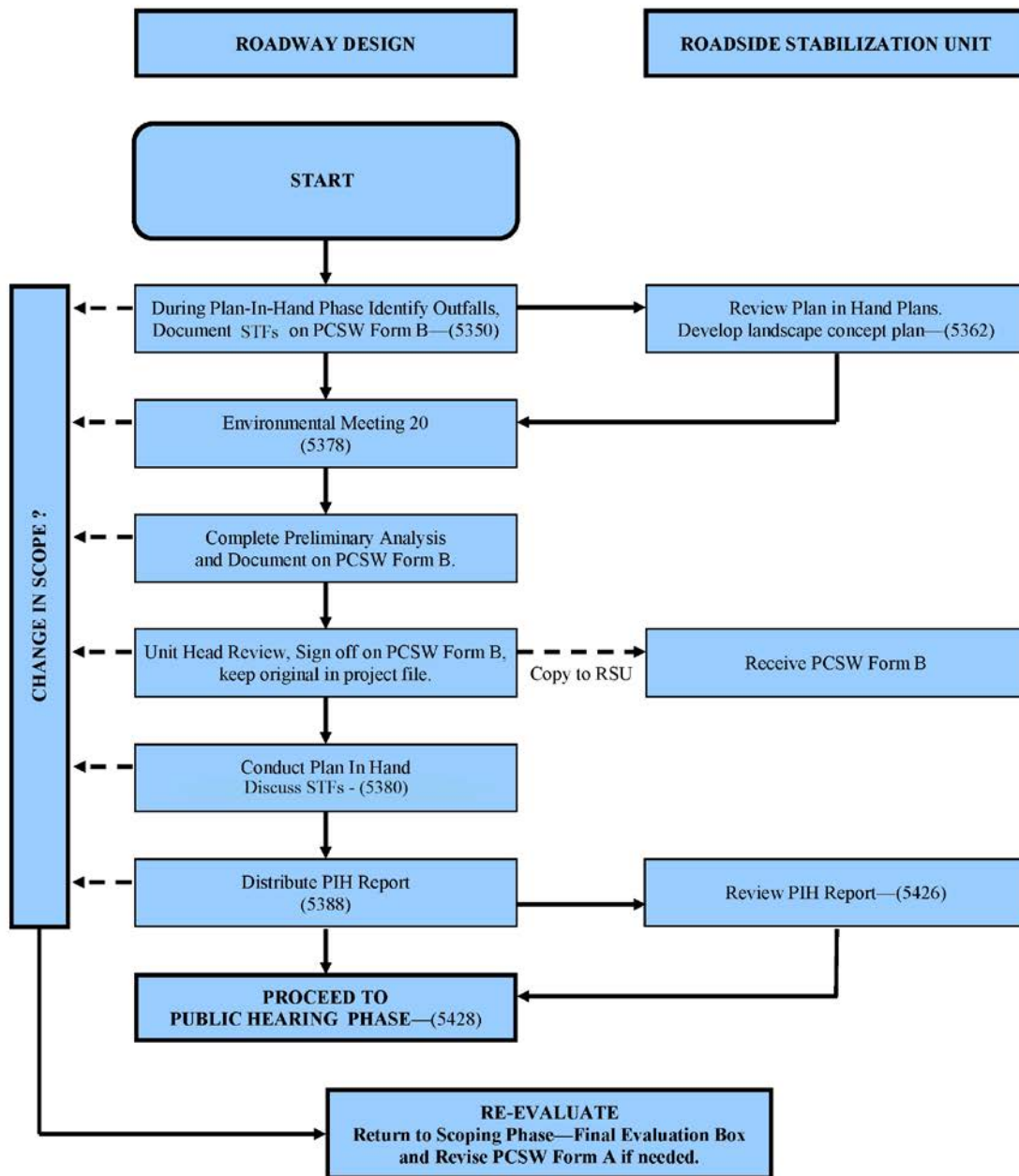

Exhibit 3.2: Stormwater Treatment Process Chart for Plan-In-Hand Phase

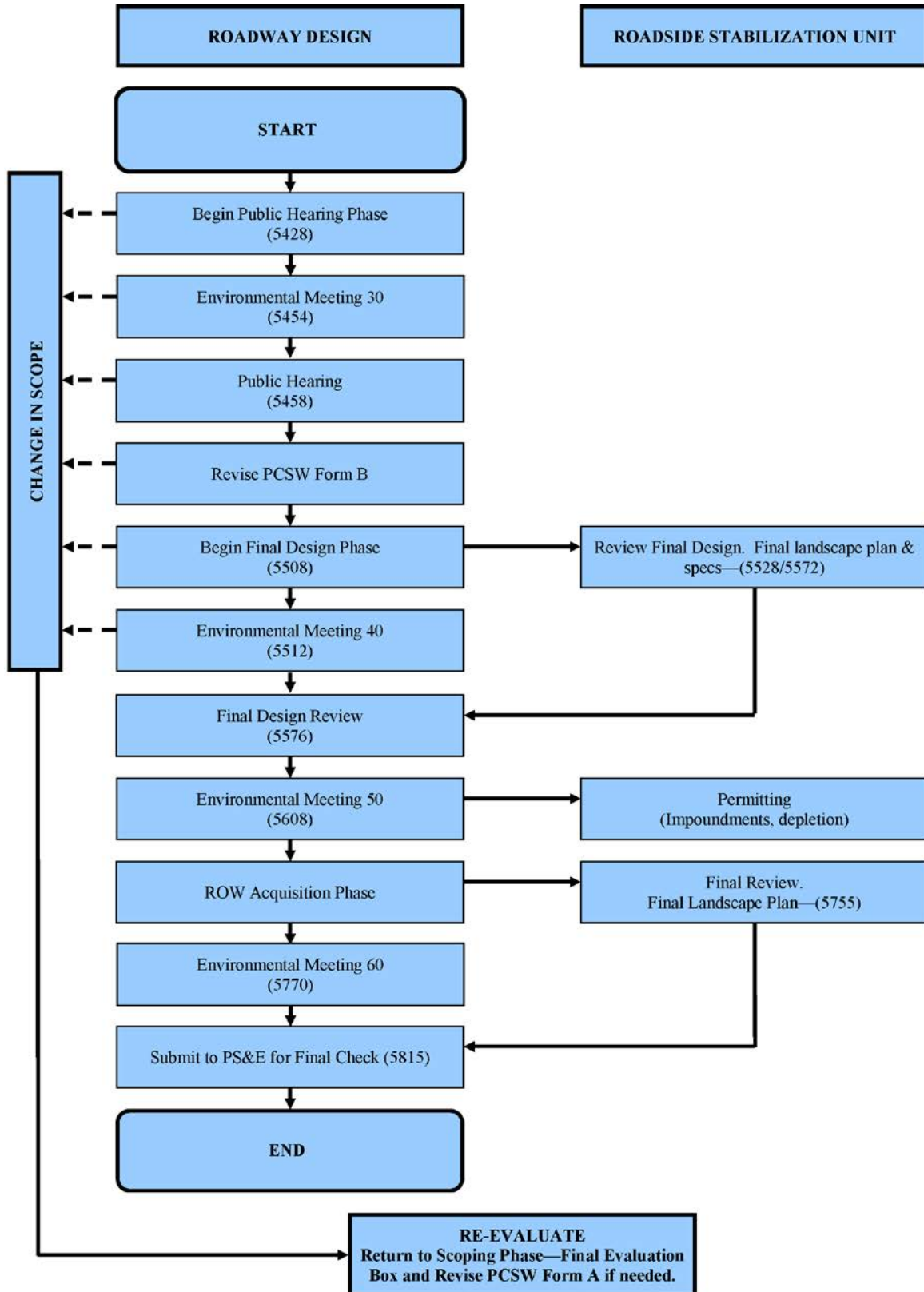

Exhibit 3.3: Stormwater Treatment Process Chart for Public Hearing and Final Design Phases

4. STORMWATER TREATMENT FACILITY DESIGN PROCESS

Stormwater Treatment Facility (STF) Design is a four step process. This process is outlined here and then discussed in detail in the following sections. The designer is responsible for completing and documenting the four steps on Form B.

4.A Plan-In-Hand Phase

During the “Plan-In-Hand Phase” (See the DPO, Ref. 3.1) of the project, the designer will complete the first three steps of the STF Design Process. These steps are:

- Step 1. Identify all Stormwater Outfall locations and determine which of these qualify as Priority Stormwater Outfalls, as detailed in Section 5. Document Priority Outfalls on Form B.
- Step 2. Calculate the Water Quality Volume and Discharge Rate at each Priority Stormwater Outfall location identified in Step 1, as detailed in Section 6. Document on Form B.
- Step 3. Select appropriate STF (s) and complete preliminary design at each Priority Stormwater Outfall identified in Step 1, as detailed in Section 7. Document on Form B.

4.B Public Hearing Phase

During the “Public Hearing Design Phase” (See the DPO, Ref. 3.1) of the project, the designer will complete the final step in the STF Design Process. This step is:

- Step 4. Complete design, as detailed in Section 8, including details for STF(s) at each Priority Stormwater Outfall identified in Step 1. Document any changes on Form B.

5. STORMWATER OUTFALLS

5.A Stormwater Outfalls

Step 1 in the STF design process is to complete an assessment of the highway’s post project drainage and to identify all stormwater outfalls located both within the project limits and the MS4 boundary. All stormwater outfall locations so located must then either be recorded on Form B or labeled on a project map / plan sheet / aerial.

To complete this task it is important to understand what is considered a stormwater outfall, therefore definitions are provided along with the **NDOT** interpretation of those definitions.

Within this Chapter the terms outfall and priority outfall refer to points where flow discharges from State right-of-way as defined in Sections 5.A.1 and 5.B. The term discharge may be used in place of outfall and the term priority discharge may be used in place of priority outfall. These terms are not intended to meet the definitions of outfall and priority outfall as defined in **NDOT’s** Illicit Discharge Detection and Elimination program.

5.A.1 Definitions

The **NDEQ** defines a stormwater outfall as:

“A point source at the point where a facility and/or municipal separate storm sewer discharges to waters of the state.”

The **NDOT** interprets this definition to mean that a stormwater outfall occurs anywhere that intentionally collected stormwater flow exits the Right-of-Way (ROW) and discharges to a water of the state.

The **NDEQ** defines Waters of the State as:

“Waters within the jurisdiction of the state including all streams, lakes, ponds, impounding reservoirs , marshes, wetlands, water courses, waterways, wells, springs, irrigation systems, drainage systems, and all other bodies or accumulation of water, surface and underground, natural or artificial, public or private, situated wholly or partly within or bordering upon the state.”

5.B Priority Stormwater Outfalls

Due to the linear nature of highway projects, outfall locations may occur at numerous locations along a project and may not directly discharge stormwater to waters of the state. In order to utilize **NDOT** resources as efficiently as possible, the stormwater treatment program will focus its efforts at Priority Stormwater Outfalls. The following definition shall be used to designate an outfall as a priority:

The **NDOT** defines priority stormwater outfalls as:

Concentrated stormwater flow locations from areas with a net increase of at least 5,000 square feet of New Pavement (including bridge surfaces) directly discharging from State ROW to the following locations within the MS4 boundary:

- Streams – Perennial and Intermittent,
- Lakes and Ponds,
- Wetlands,
- Municipal Separate Storm Sewer System,
- Ephemeral drainage that directly discharges to one of the above located beyond the ROW line and within the distance identified in Appendix N.

Utilizing these criteria, the designer documents which outfalls, listed on Form B or shown on the project map / plan sheet / aerial, are considered to be priority stormwater outfalls. Priority stormwater outfalls must be documented on Form B.

There are two separate 5000 sq. ft. thresholds that require distinction by the designer.

1. Preliminary project evaluation of 3R projects includes a 5000-sq. ft. of new pavement threshold as described in Section 3.A.
2. Determination of priority outfalls is based on a threshold of a 5000-sq. ft. of new pavement discharging from State ROW as described in this section.

EXHIBIT 3.3a shows the distinction between these thresholds within the **NDOT** MS4 process.

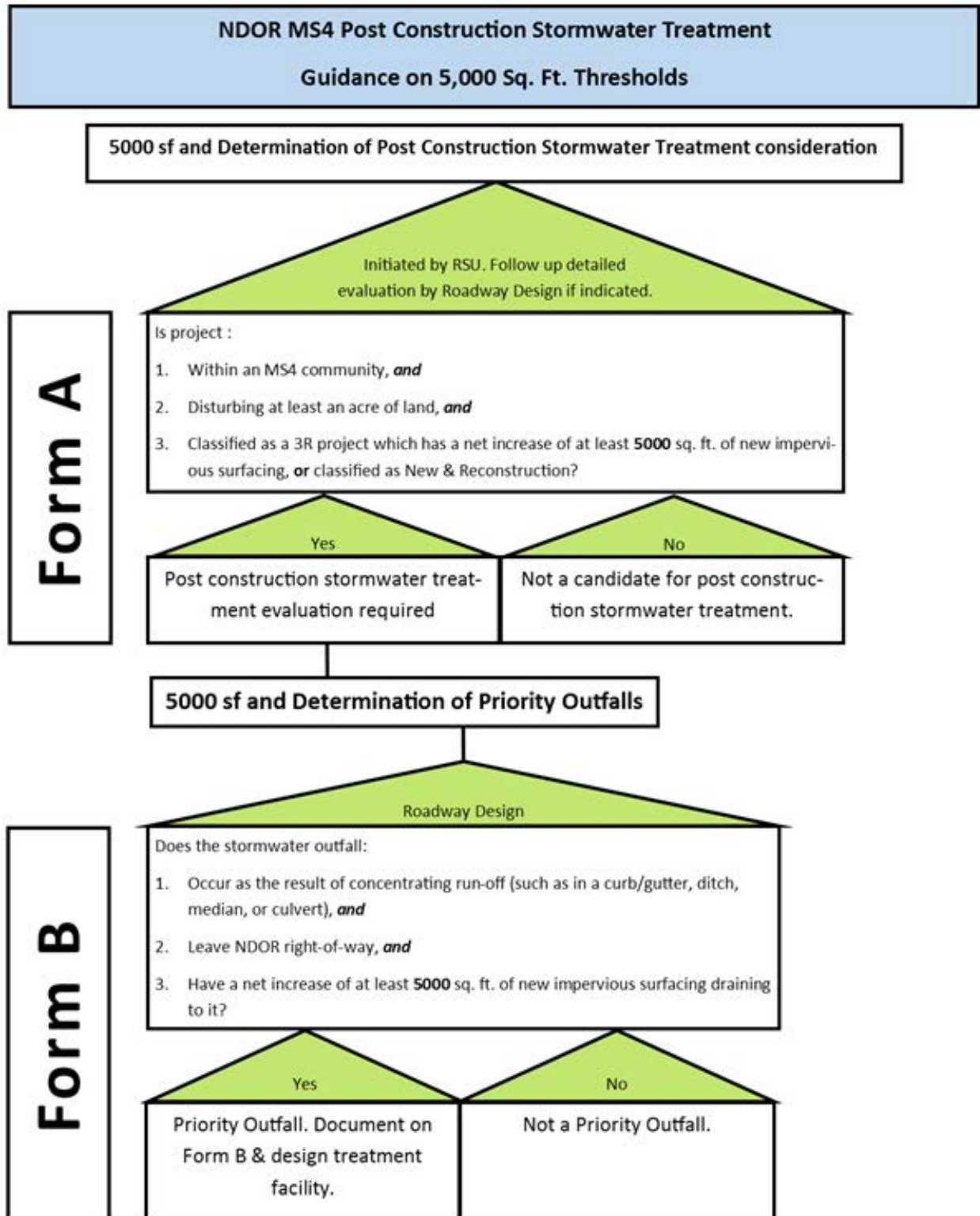

Exhibit 3.3a Guidance on 5000 Sq. Ft. Thresholds

5.B.1 Priority Stormwater Outfalls Off Project

Outfall locations may occur *on* or *off* the project site. Concentrated stormwater runoff from a project must be followed to the point that it leaves State ROW regardless of whether or not that point is within the project boundary. Once it leaves State ROW, *on* or *off* the project site, the determination is then made as to whether the outfall is a priority outfall. If it is determined that the outfall location is a priority outfall, treatment must be addressed per this Chapter, preferably at a treatment point on the project.

5.C Example Cases of Stormwater Outfalls

Case 1 The new highway pavement flows to the highway foreslope which drains to natural ground that continues to flow away from the highway. After the stormwater leaves the highway ROW it flows into the city street gutter and is collected by the city's storm sewer system.

Result: In Case 1 the stormwater discharge from the highway foreslope is not a stormwater outfall for the **NDOT** project; according to the definitions in Section 5.A.1 the stormwater needs to be intentionally collected before it exits the highway ROW to be a stormwater outfall. In this case the stormwater flows off the highway ROW in un-concentrated condition before it is collected (in the street's gutter).

Case 2 The new highway pavement flows to the highway ditch which drains to a low point and discharges off the ROW on to the adjacent field where it disperses (see upper left part of EXHIBIT 3.4).

Result: In Case 2 the stormwater discharge from the low point of the highway ditch is a stormwater outfall for the **NDOT** project, but is not a priority stormwater outfall. According to the definitions in Section 5.A.1 the low point of the ditch is a stormwater outfall; the stormwater is collected by the highway ditch and discharged in a concentrated manner from the highway ROW. However, the stormwater outfall does not meet the requirements given in Section 5.B for it to be a priority stormwater outfall. The stormwater disperses into the adjacent field and does not flow directly into a stream, lake, wetland, storm sewer or into a drainage which leads to one.

Case 3 The new highway pavement flows to the highway ditch and median drain which combine and discharge off the ROW into a ephemeral drainage swale that leads to a perennial stream (see upper right corner of EXHIBIT 3.4). The survey shows the swale to be 8 feet wide, has a grade of 0.8% and the distance to the stream is 180 feet. A total of 0.8 acres of new pavement drains to the median and ditch.

Result: In Case 3 the stormwater discharge from ROW to the drainage swale is a stormwater outfall. According to the definitions in Section 5.A.1 the stormwater collected by the highway ditch and median drain and discharged in a concentrated manner from the highway ROW make the discharge point a stormwater outfall. Because the discharge is to a ephemeral drainage swale that leads to a perennial stream, the table in Appendix N is used to determine if the stormwater outfall is a priority stormwater outfall.

To use the table in Appendix N, it is necessary to know the Swale Width and Grade, the Water Quality Volume (WQV) Discharge Rate, and the distance traveled in the swale before it reaches the stream.

- The swale width is given as 8 feet. This lies between the 10-foot and 5-foot swale values in the table - when the swale width lies between two table values round down - use the 5-foot width.
- The swale grade is given as 0.8%, between the 0.5% and 1% grades given in the table – when the swale grade lies between two table values round up – use the 1% grade.
- The WQV discharge rate is based on the area of new pavement. From EXHIBIT 3.5 it can be seen that the 0.8 acres of New Pavement generate a WQV peak discharge of 0.7 cfs. The 0.7 cfs discharge lies between the 0.45 cfs and 0.9 cfs values in the Appendix N table – when the WQV discharge rate lies between two table values round up – use the 0.9 cfs discharge rate.

Using the values determined in the bullet points above (a 5-foot wide, 180-foot long swale at 1% grade with 0.9 cfs WQV discharge), which when applied to the table in Appendix N, it can be determined that the outfall is a priority stormwater outfall. Based on Appendix N, the swale would need to exceed 225 feet in length to not be categorized as a priority stormwater outfall.

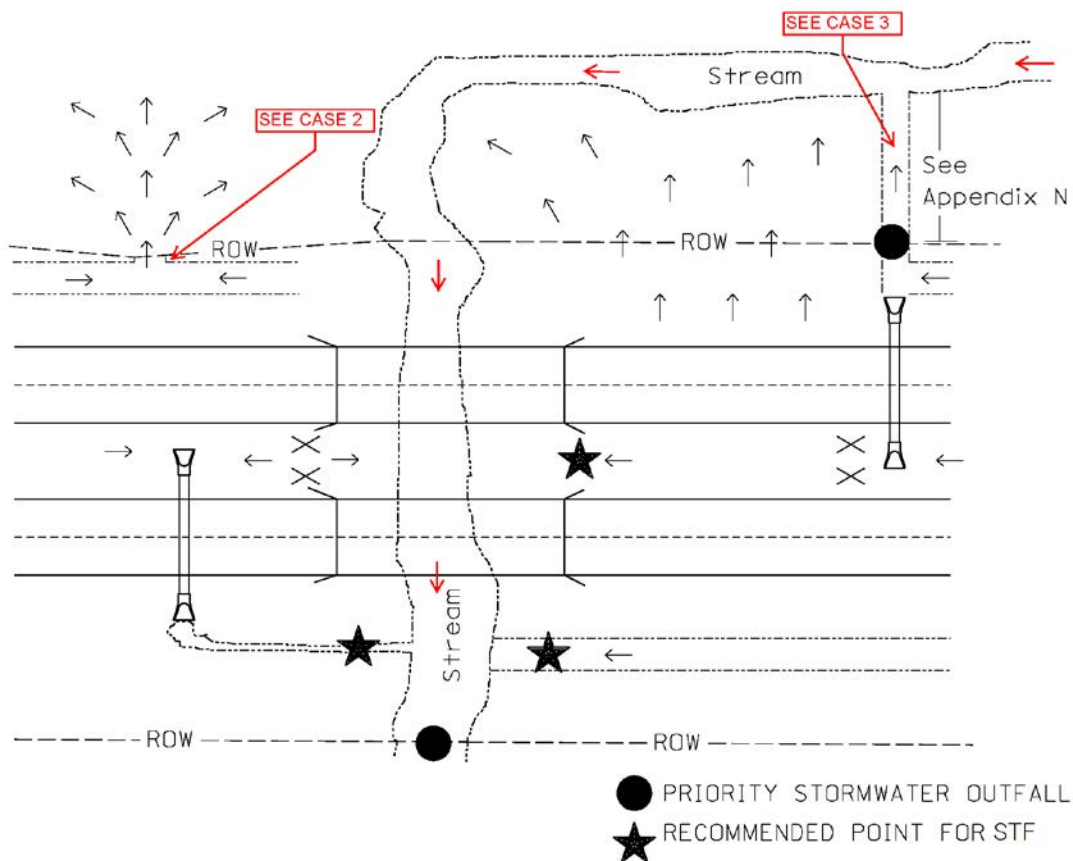

Exhibit 3.4: Examples of Priority Stormwater Outfall Locations

6. STF HYDROLOGY

Step 2 in the STF design process is to calculate the WQV and WQV Discharge Rate of the stormwater runoff from the Treatment Drainage Area, at each stormwater outfall classified as a priority in Step 1. To assist in this task, the **NDOT** has established definitions for the water quality volume and water quality discharge rate, which are provided below. Also provided is a short discussion of how those values were determined.

The designer determines the water quality volume and water quality discharge rate, during the plan-in-hand phase for each of the priority stormwater outfalls. These values are recorded on Form B.

6.A Water Quality Volume (WQV)

WQV is defined as the amount of storm water runoff from a given storm that should be captured and treated in order to remove a majority of storm water pollutants on an average annual basis.

The **NDOT** has determined that the WQV is the first one-half ($\frac{1}{2}$) inch of runoff from the Treatment Drainage Area (see Section 6.A.1). The calculation for this volume is provided in the following equation.

$$\text{WQV} = 0.5 \text{ inch} \times \text{Treatment Drainage Area (ft}^2\text{)} / 12 = \text{cu ft of Runoff Requiring Treatment (III.1)}$$

The WQVs for drainage areas up to 5 acres have already been calculated by the **NDOT** and placed in [EXHIBIT 3.5](#). The designer should use these values when sizing STF for these drainage areas.

6.A.1 Treatment Drainage Area

The Treatment Drainage Area is defined as the area of New Pavement placed on the project.

The Treatment Drainage Area may be increased due to run-on intermingling with the runoff from the areas defined above. Run-on is further discussed in Section 6.C.

6.A.2 Selection of Water Quality Volume

In establishing treatment criteria, the **NDOT** is following guidance provided in the EPA document [National Management Measures to Control Nonpoint Source Pollution from Urban Areas](#) (Ref. 3.2). This document recommends reducing the post development loadings of Total Suspended Solids (TSS) by a minimum of 80% of the average annual TSS loadings.

The 80% TSS removal criteria for STF selection is based on several factors:

- TSS is a measure of the concentrations of sediment and other particles suspended in water.
- TSS can be an indirect measure of other pollutants carried by runoff, because organic compounds, metals, and nutrients such as phosphorus are typically attached to sediment particles.
- Research has shown that many STFs or combinations of STFs can achieve the 80% removal goal.

The **NDOT** has determined that the 80% goal can be obtained by collecting and treating either the WQV discussed above, or the WQV Discharge Rate discussed below.

6.B Water Quality Volume Discharge Rate

The WQV Discharge Rate is the peak stormwater discharge generated by the water quality volume rainfall event using the **Natural Resources Conservation Service (NRCS)** Curve Number (CN) procedure. The water quality volume rainfall event is the 0.75 inch, 24-hour rainfall, assuming a CN value of 98 (pavement) and a Time of Concentration (Tc) of 5 minutes.

The WQV Peak Discharges for drainage areas up to 5 acres have already been calculated by the **NDOT** and placed in the following EXHIBIT 3.5. The highway designer should use these values when sizing STFs for these drainage areas.

To determine a WQV peak discharge for drainage areas greater than 5 acres, the **NRCS** CN procedure must be used. The designer can either assume the entire area is pavement with a CN value of 98 or use the weighted Q method of the CN procedure. The weighted Q method calculates the runoff from each land cover and soil complex individually and then sums the runoff peaks.

Example: A 10 acre residential neighborhood with ¼ acre lots in hydrologic soil group B soils.

Weighted Q Method

The residential neighborhood is assumed to have 38% impervious area, 3.8 acres at CN of 98, and 62% grass cover, 6.2 acres at CN of 61. Using the WQV rainfall event, 24-hour Rainfall = 0.75 inch and the assumed Tc = 5 minutes, calculate the peak discharge for each area (impervious area and grass cover) independently:

<u>Area</u>	<u>Discharge</u>
Impervious area	3.4 cfs
Grass area	<u>0.02 cfs</u>
Add Hydrographs	3.4 cfs (WQV Peak discharge)

Standard Method (Weighted CN Method)

The residential neighborhood is assumed to have 100% ¼ acre lots, 10 acres at CN of 75. Using the WQV rainfall event, 24-hour Rainfall = 0.75 inch and the assumed Tc = 5 minutes, calculate the peak discharge for entire area.

<u>Area</u>	<u>Discharge</u>
Residential ¼ Acre	0.0 cfs.

The weighted Q method calculates a WQV peak discharge as 3.4 cfs. This compares to the standard method of Weighted CN which calculates a discharge rate of 0 cfs. Empirical evidence and common sense both dictate that a 0.75-inch rainfall will generate at least some runoff, therefore the Weighted CN method can be rejected. Under small rainfall rates the Weighted Q method more accurately estimates the peak discharge rates that will be experienced.

Drainage Area (Acres)	WQV ½ inch Runoff (cubic feet)	WQV Discharge Rate (cfs)	Drainage Area (Acres)	WQV ½ inch Runoff (cubic feet)	WQV Discharge Rate (cfs)
0.1	182	0.10	1.25	2269	1.10
0.2	363	0.20	1.5	2723	1.30
0.3	545	0.30	1.75	3176	1.60
0.4	726	0.40	2.0	3630	1.80
0.5	908	0.45	2.5	4538	2.20
0.6	1089	0.50	3.0	5445	2.70
0.7	1271	0.60	3.5	6353	3.10
0.8	1452	0.70	4.0	7260	3.60
0.9	1634	0.80	4.5	8168	4.00
1.0	1815	0.90	5.0	9075	4.40

Exhibit 3.5: Water Quality Volumes and Peak Discharges for Selected Acreages

The values used in [EXHIBIT 3.5](#) were calculated using the **NRCS** CN procedure. The assumptions for the WQV peak discharges were a 5-minute Tc and a CN value of 98.

6.C Addressing Stormwater Run-On

Stormwater run-on is defined as any stormwater which intermingles with the Treatment Drainage Area runoff prior to treatment. This can occur as either overland flow or underground flow via culvert or storm sewer pipe. **NDOT** projects can receive stormwater run-on from both adjacent properties and other parts of the highway or right-of-way.

Stormwater run-on which is allowed to intermingle with the Treatment Drainage Area runoff must be included in the WQV to be treated. Intermingling can occur:

- At the source, such as when existing lanes drain across a new lane
- Along the conveyance path, such as when multiple inlets drain to the same pipe or ditch
- At the treatment point, such as when multiple outlets flow in to the same basin

The additive nature of stormwater run-on is necessary both as a regulatory compliance measure and to avoid over-flowing an under-sized STF system because higher than design volumes / flow rates are directed to it.

Stormwater run-on which can be diverted from intermingling with the Treatment Drainage Area runoff does not require treatment.

Stormwater run-on may be problematic for designers, for instance, considering a widening project where the Treatment Drainage Area drains into the roadside ditch. The stormwater then intermingles with a significant amount of stormwater run-on from a nearby development that is also draining into the **NDOT** ditch. Any number of small, low cost STFs may have been sufficient to treat the Treatment Drainage Area runoff. However, when the additional run-on from the development is factored in, a larger, more expensive STF may be required to treat the ½-inch water quality volume.

In the “Plan-In-Hand Phase:” (See the DPO, Ref. 3.1) the designer in consultation with their **Unit Head** may choose to separate stormwater run-on from the Treatment Drainage Area’s stormwater runoff or allow it to intermingle at some point. When stormwater run-on is kept separate from the Treatment Drainage Area runoff, the designer can choose to treat only the Treatment Drainage Area run-off WQV. However, when the two are allowed to intermingle, the WQV of both the run-on and runoff shall be addressed. EXHIBIT 3.6 provides a flow chart showing when stormwater run-on must be treated. See EXHIBIT 3.7 for an example of dealing with stormwater run-on.

The designer documents on Form B the locations where stormwater run-on enters and exits the project and whether and how the stormwater run-on will be separated from project runoff, if discharging to a priority stormwater outfall. The **Unit Head** verifies that any off-site run-on has been accurately accounted for. Appropriate methods for dealing with the off-site run-on can be discussed during the Environmental Coordination Meeting.

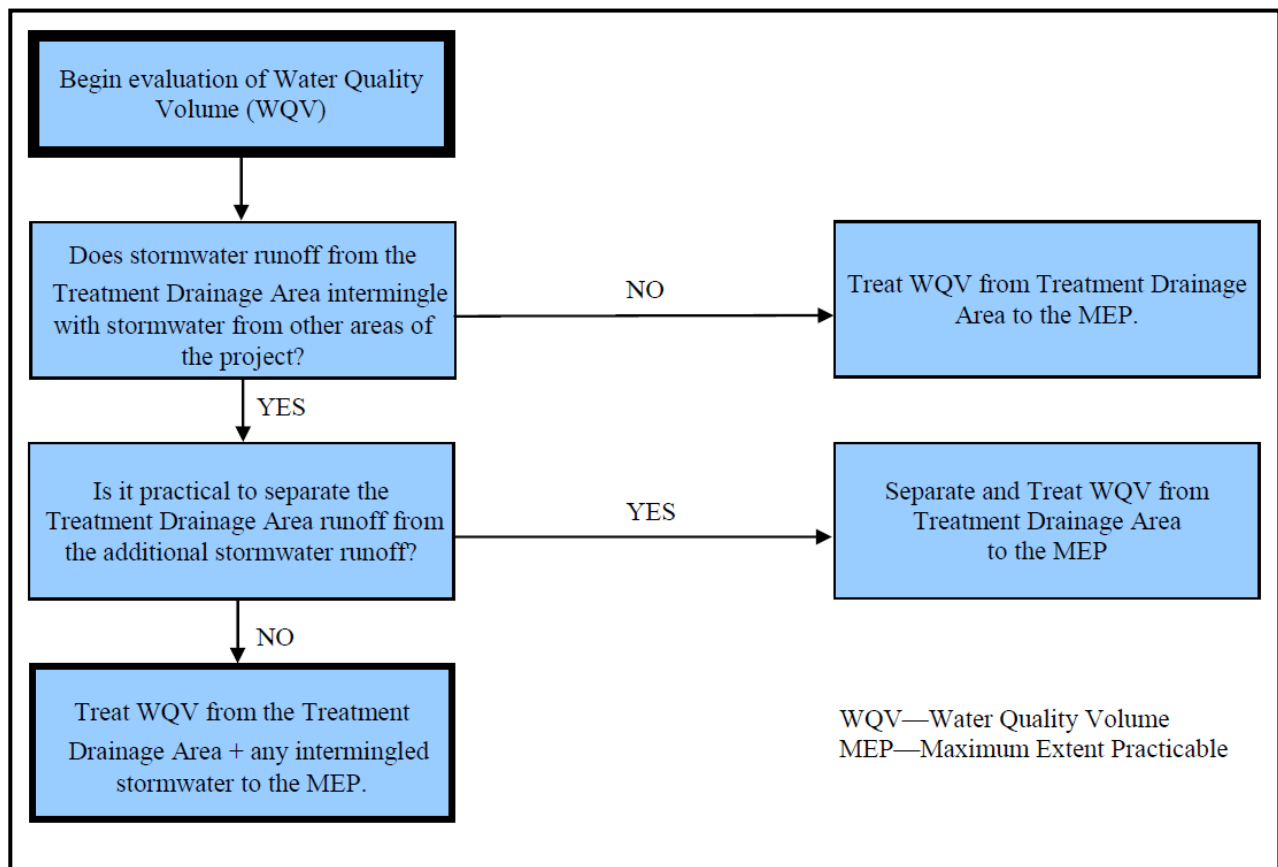

Exhibit 3.6: Stormwater Run-On Flow Chart

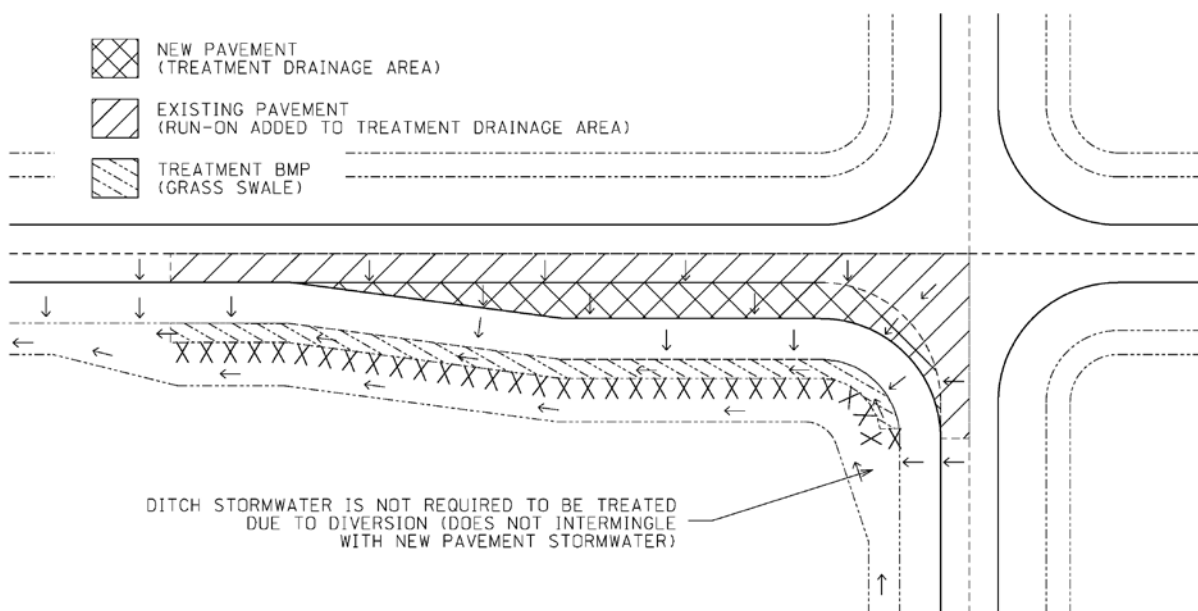

Exhibit 3.7: Example of Stormwater Run-On

It is desirable to avoid having to treat excessive run-on from impervious areas, particularly off site run-on. Designers should strive to treat stormwater prior to it intermingling with run-on from impervious areas on and off the project site. This may be accomplished by establishing a treatment point prior to the intermingling, or by physical separation of the flows as necessary to allow treatment prior to comingling. Designers will take care to maintain the existing drainage outfall pattern when considering separation of flows for stormwater treatment purposes.

If it is not feasible to treat run-on prior to intermingling, such as when adding an outside lane to existing roadway, then stormwater treatment facilities will be sized to account for all stormwater run-off from impervious areas. Providing treatment to the “maximum extent practicable” as indicated in [EXHIBIT 3.6](#) means providing treatment for at least 80% of the Water Quality Volume. If this threshold cannot be achieved, other treatment options such as on-site mitigation (See Section 7.A.4.1) shall be pursued.

Treatment of run-on *from existing impervious areas within NDOT right-of-way* will be considered “excess” treatment and may be claimed as a “treatment credit.” This credit may be used to offset requirements for new impervious pavement for which treatment cannot be accomplished. Designers will consider treating prior to intermingling before taking a “treatment credit” approach. Documentation will occur on Form B.

If it is not feasible to treat run-on from existing impervious areas within **NDOT** right-of-way or when inseparable stormwater run-on is received from impervious areas off State right-of-way, designers will consult and coordinate with **RDC** and/or the local municipality for other on- or off-site mitigation options.

If stormwater run-on to the project from *pervious* areas occurs, it will not increase the TDA.

Protection and maintenance of stormwater treatment facilities (STFs) will be included in agreements with the local community, who will be responsible for protecting existing STFs from untreated run-on as future community development occurs.

7. STF SELECTION AND PRELIMINARY DESIGN

Step 3 in the STF design process is to evaluate each Priority Stormwater Outfall identified in Section 5, select an appropriate STF or series of STFs, and complete a preliminary design of the STF. To complete this task the **NDOT** has identified several general considerations and established a STF Selection Chart to assist the designer with this process.

The designer should review the general considerations and select a STF for each of the priority stormwater outfall locations. The designer will record this selection on Form B.

7.A General Considerations

7.A.1 Online and Offline Treatment

STF s can be designed as either online or offline. An online STF is one where all stormwater runoff generated by the project is conveyed through the STF. By contrast, an offline STF is one where only a selected amount of stormwater runoff, frequently the WQV, is diverted through the STF, and all additional runoff bypasses the STF. See [EXHIBIT 3.8](#) for a graphical representation.

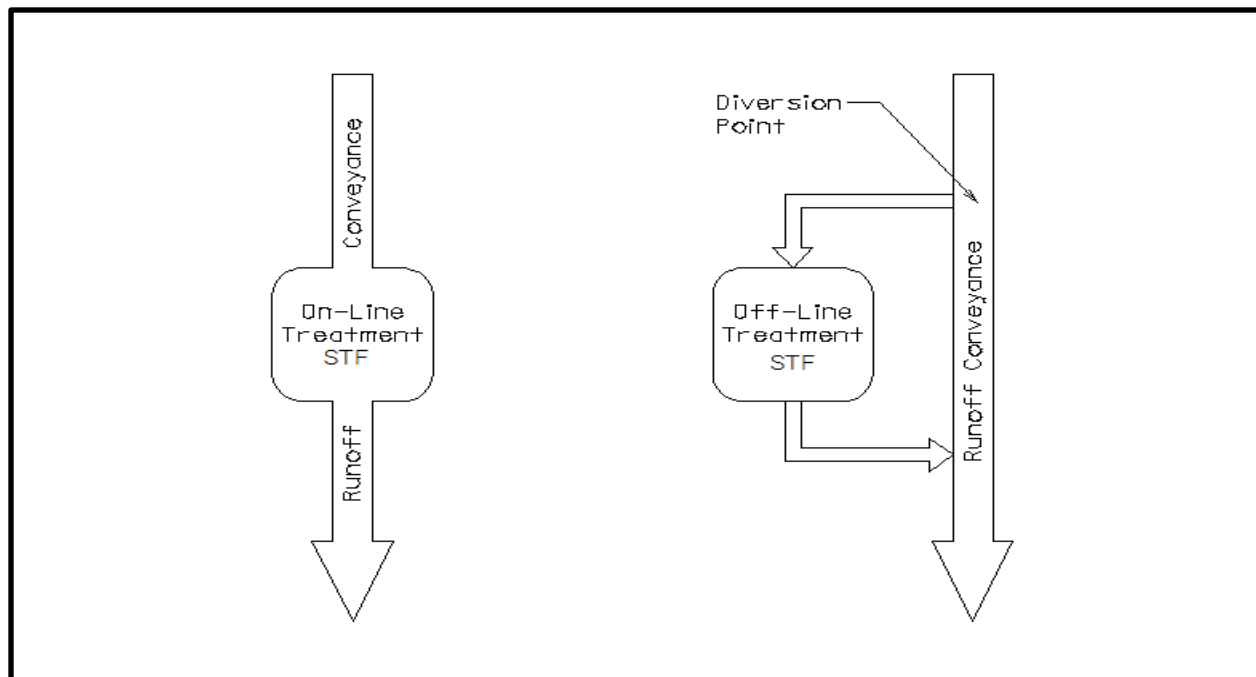

Exhibit 3.8 Schematic of Online and Offline STFs

An online STF is located within the stormwater runoff conveyance pathway. Flows up to the WQV are captured and treated by the STF, while the larger storm events are passed through the STF without treatment. The online STF needs to be able to convey anticipated stormwater flows without adversely impacting the STF, the adjacent highway, highway right-of-way, or adjacent property. Inlet and outlet structures need to be designed to both control the water quality volume and convey the highway design storm.

An offline STF is located outside and separate from the normal stormwater runoff conveyance pathway. Flows up to the WQV are diverted into the STF from the normal stormwater runoff conveyance pathway, where they are captured and treated. Large flow events are generally allowed to bypass or are actively diverted around the STF. In some cases, an offline STF may be designed to collect flows above the WQV, for secondary reasons, but are not required to treat those larger flows. An offline STF is only designed to handle the stormwater flows diverted to it and can be located adjacent to or a distance away from the stormwater runoff conveyance pathway.

The “STF’s Design Guides”, located in Appendix P, include recommendations on whether a STF should be designed as either offline or online.

7.A.2 Safety and Aesthetics

Safety is a consideration when designing STFs. To operate effectively some STF s need to impound water for a period of time. This may introduce the potential for ponding on or near roadways. It is the **NDOT’s** preference that STFs be located outside the lateral obstacle clearance zone. Refer to Chapter Six: The Typical Roadway Cross-Section, Section 3 of the Roadway Design Manual (Ref. 3.3) (<http://dot.nebraska.gov/business-center/design-consultant/rd-manuals/>), for guidance when placing STFs within the lateral obstacle clearance zone.

The following guidelines apply to the location and application of STFs:

- STFs should be designed so the roadway surface is not subjected to ponded water (see Chapter 1)
- Embankments such as dikes placed within the lateral obstacle clear distance should be constructed with 1:6 or flatter slopes
- Fencing may be needed around impoundments located within urbanized areas

Aesthetics may also be a factor when selecting and designing STF s since many of them require the establishment of vegetation to function properly. Efforts should be made to blend the STF into the surrounding landscape.

7.A.3 Coordination with Adjacent MS4

Coordination with federal, state, and local (city and county) governmental agencies is often necessary due to legal implications or special local drainage ordinances. Communication with adjacent MS4 permit holders and other municipalities (cities and counties) may be required whenever a proposed project results in stormwater discharges from the **NDOT’s** stormwater drainage systems to stormwater drainage systems owned and operated by the local MS4 or municipality, and vice versa.

Coordination with the adjacent MS4 Community may take on the form of an Agreement between the **NDOT** and the Community. When it is necessary to complete an Agreement, the DPO (Ref. 3.1) and **NDOT's** Operating Instruction 45-5 – “Agreements”, included in Appendix R, must be followed. Language will be included in the municipal agreement assigning protection, operation, and maintenance of the constructed stormwater treatment facilities (STFs) to the local MS4 community.

7.A.4 Off-Site Stormwater Mitigation

In some cases it may not be practicable to provide stormwater treatment within the project limits due to various constraints such as site limitations (available right of way), costs, or other obstacles. If on-site mitigation is not feasible, off-site mitigation may be an option at other locations within the local watershed or MS4.

When all on-site mitigation options have been exhausted and documented, contact **RDC** to determine if off-site mitigation is feasible.

7.A.4.a On-Site Stormwater Mitigation

Run-off from other existing impervious areas within project limits that do not require treatment may be considered for treatment in the following conditions:

- 1) When a project is not in a TMDL or other area with defined water quality requirements, and
- 2) When it is not feasible to treat new impervious areas and/or run-on from any impervious areas, *within the TDA*.

This is considered *on-site mitigation*. Documentation should take place on Form B describing the Priority Outfall, the TDA being mitigated, and the location where on-site mitigation (treatment) will occur.

If a project is not in a TMDL or other area with defined water quality requirements and it is not practical to treat new impervious areas and any run-on, *within project limits*, then off-site mitigation may occur. If the project is in a TMDL or other area with defined water quality requirements, stormwater run-off must be treated at the location and mitigation is not an option.

On-site and off-site mitigation will require the concurrence from **RDC and Roadway Design Hydraulics Units** to verify that treatment is not practical within the TDA and/or within the project limits. If off-site mitigation is justified, **RDC** will note the area requiring treatment and account for that treatment in a separate stormwater treatment facility within the community's **NDOT MS4** boundary. Documentation will occur on Form B.

7.A.5 Maintenance Responsibilities

The responsibility for maintenance of the STF s on a project varies over time and by location.

- **During Construction** – The contractor will be responsible for maintaining the completed STF s
- **During Vegetation Establishment Period** – After the contractor is released from the project, the **NDOT** will be responsible for maintaining the completed STF s until the stormwater permit obligations are complete
- **Post Vegetation Establishment Period** - The maintenance responsibilities for non-freeway highway appurtenances located within corporate limits reside with the municipalities, according to Nebraska State Statutes, Sections 39-1339, 39-1372 and 39-2105 (<http://law.justia.com/codes/nebraska/2009/Chapter39/Chapter39.html>),
 - **Interstates and Freeways** – The **NDOT** will continue to be responsible for maintaining the STFs
 - **Non-Freeways within Corporate Limits** – The municipality is responsible for continued maintenance of the STFs
 - **Non-Freeways outside Corporate Limits** – The **NDOT** will continue to be responsible for maintaining the STFs

The designer should be aware of the agency ultimately responsible for maintaining the STFs. The adjacent MS4 Community may have limitations and/or concerns about maintenance requirements of particular STFs.

The detailing of maintenance responsibilities may require an Agreement between the **NDOT** and the MS4 Community. When it is necessary to complete an Agreement, the DPO (Ref. 3.1) and **NDOT's** Operating Instruction 45-5 - Agreements must be followed.

7.A.6 Right-of-Way Considerations

Acquisition of property rights may be necessary to incorporate STFs in the roadside environment. This should be discussed in preliminary design to provide adequate time to determine if additional ROW will be available.

7.A.6.a Retention of ROW for STFs

STFs should be identified on the ROW plans to protect them against sale as excess land. Since many of these STFs will detain/retain water and may develop wetland conditions, it is necessary to permanently label and maintain these STFs as “Stormwater Treatment Facilities”.

7.A.7 Compliance with Chapter One – Drainage Design

The designer and **Unit Head** are reminded that the STF's designed under Chapter Three must also comply with the policies and procedures of Chapter One – Drainage Design.

In Chapter Three, STF's are designed to minimize the potential discharge of pollutants in highway stormwater runoff to waters of the state during the WQV Rainfall Event (0.75-inch 24-hr storm). Chapter One is used to define and direct the peak discharges of stormwater runoff during the highway Design Storms (2-year to 100-year storm events).

STF's must be designed to the requirements of both Chapter Three and Chapter One of this Manual. The STF must be able to both collect / treat the WQV Rainfall Event and convey the peak discharges occurring during the highway Design Storm.

7.B STF Selection Process

7.B.1 Existing Conditions

The first step in the STF Selection Process is to determine the effectiveness of the existing site conditions in treating the WQV.

To complete this step the designer should evaluate the conditions between the Treatment Drainage Area and the Priority Stormwater Outfall to determine if there are existing features at the site (e.g. vegetated swales or detention basins, etc.) that may be utilized for water quality treatment. These existing features may not have been originally designed to treat stormwater, but as long as they meet the criteria, or can be enhanced to meet the criteria outlined in this Chapter, a designer may take credit for the water quality treatment they are providing.

Existing features evaluated and used as STF's are documented on Form B.

7.B.2 STF Selection Guidance

The second step in the STF Selection Process is to select and size the STF for the Treatment Drainage Area WQV.

A flowchart illustrating the STF selection process is shown in [EXHIBIT 3.9](#). The designer can use this flowchart to select an appropriate STF at each priority outfall location. It may be necessary to combine STF's (e.g., a Detention Basin may be preceded by a grassed swale) to attain the treatment goal.

[EXHIBIT 3.10](#) provides a tabulation of the available STF's and their suitability to various locations and conditions.

The selection of STF's is documented on Form B. The designer utilizes the corresponding STF Design Guide given in Appendix P to complete preliminary design.

When the designer has completed a preliminary STF design for the project, the designer's **Unit Head** will review and sign off on Form B. The **Unit Head** will then forward a copy of the Form B to **RDC** for review. Environmental Coordination Meeting 30 can be used to discuss the preliminary STF designs.

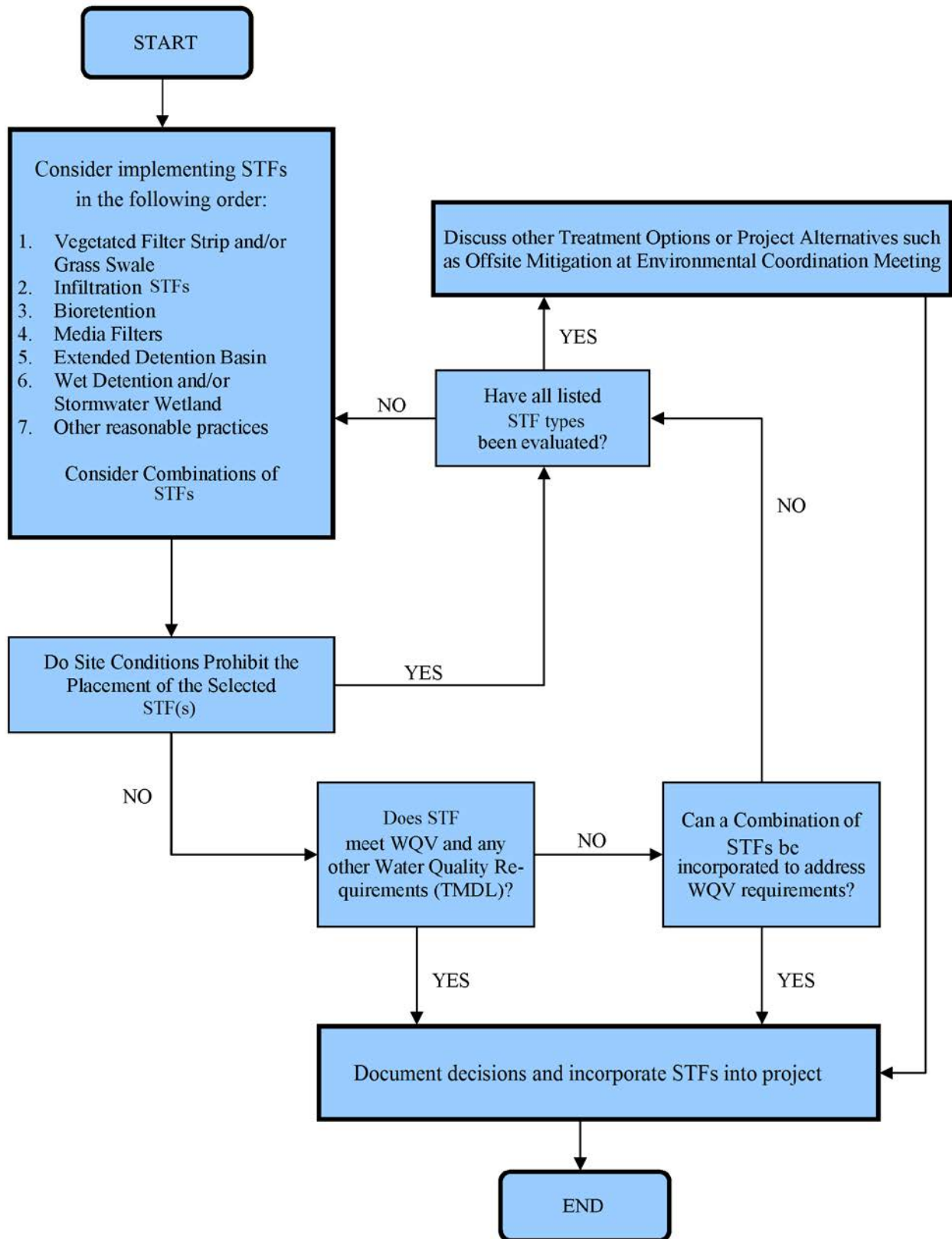

Exhibit 3.9 STF Selection Chart

7.B.2.a Order of STF(s)

The order of STFs listed in the selection chart is a suggested ranking which shows the preference of the **NDOT** for treating stormwater discharges. The suggested order moves from less intrusive methods, both from a visual and maintenance perspective, to methods that require more area, are more costly to build, and require more maintenance. Some of the least intrusive designs may provide the best means to obtain the **NDOT's** water quality objectives. The designer, in consultation with their **Unit Head**, may choose to implement any of the STFs without going through the listed order.

See Section 7.B.2.d for a discussion on Combining STFs.

7.B.2.b Site Conditions

Site-specific conditions can affect operations, maintenance, construction costs, safety and aesthetics of STFs. When designing a STF, the designer needs to give proper consideration to recovery zones, setbacks, hydraulic head, and maintenance access roads and ramps.

Each STF has minimum design parameters that need to be met in order to treat the stormwater discharge effectively. For example, grass swales require ditch slopes of 4% or flatter, extended detention basins require both a specific amount of volume and a minimum width to length ratio, and infiltration basins require adequate space and a relatively high native soil infiltration rate. The site conditions where a STF will be located often determine whether or not the minimum design parameters are achievable for a particular STF.

When a desired STF cannot be placed due to a site limitation, the designer should select a different STF and evaluate it for the site conditions. The designer may choose to place multiple STFs that each treat a limited amount of the WQV (see next section), but when added together treat the entire WQV. See Section 7.B.2.d for additional discussion on combining STFs.

7.B.2.c Design STF for WQV

The “STF Design Guides” provide the specifics for designing each of the approved STFs. The designer uses these guides and the calculated WQV goal as discussed in Section 6 to establish the design for the selected STF.

Contact the **Roadway Design Hydraulics Engineer** and **RDC** for assistance with designing STFs for water quality requirements other than the 0.5-inch WQV goal (example: TMDL requirements).

When site conditions allow the placement of a STF, but do not allow for it to treat the entire WQV goal, the designer in consultation with their **Unit Head** may either choose to evaluate another STF or add multiple STFs in series to attain the WQV goal (see Section 7.B.2.d Combining STFs).

7.B.2.d Combining STFs

When the calculated WQV or other water quality goal exceeds the capacity of a single STF, the designer may be able to combine several of the same or multiple STFs in sequence to achieve the desired WQV or goal.

Where STFs are used in combination, the designer shall first determine the parameters of each of the STFs that can be placed, and then using the “STF Design Guides” calculate the amount of WQV each STF can treat. The sum of the WQV from each STF in the sequence should total 100% of the Treatment Drainage Area WQV goal.

7.B.2.e Other Treatment Options or Project Alternative

There may be occasions when the site conditions are such that the WQV goal cannot be met utilizing the process provided and the STFs approved by the **NDOT**. The designer should bring this issue to the project’s next Environmental Coordination Meeting (See **EXHIBIT A** of the DPO, Ref. 3.1) where additional options can be discussed. The designer is also encouraged to consult with **RDC** and the **Roadway Design Hydraulics Section** for assistance.

7.C STF Summary

The following is a brief description of all approved STFs. Detailed design guides for each STF are available in Appendix P.

7.C.1 Vegetated Filter Strips

Vegetated Filter Strips are zones of vegetation through which stormwater runoff is directed. Vegetated filter strips intercept and convey sheet runoff from an impervious area (i.e. highway) and treat the runoff by filtration through vegetation, sediment deposition, and infiltration and adsorption by soil. They are effective if the velocity of sheet flow is slow, providing an opportunity for sediments and other pollutants to settle and be filtered. Vegetated filter strips can be used to enhance the water quality of stormwater runoff on small sites, or as pre-treatment for another structural stormwater STF. Maintaining sheet flow and preventing concentrated flows are important components in the design of vegetated filter strips.

Examples:

- Roadside vegetated foreslope
- Flattened backslope receiving runoff from an adjacent parking area or development

Design Notes:

- Required dense vegetative growth
- Appropriate for small drainages (<1 acres)
- Water must enter as sheet flow across the entire filter strip (Level Spreader)
- Minimum slope length approx. 20 ft
- Slope range between 2-17%
- Commonly used as pretreatment for other STFs
- Low maintenance and low cost

7.C.2 Grass Swales

Grass swales are open, shallow channels with vegetation covering the side slopes and bottom that collect and slowly convey runoff flow to downstream discharge points. A grass swale is designed to meet nominal treatment of runoff for the WQV and can be an important component in a combined STF system. In general, grass swales are very similar to roadside ditches with mild slopes and dense vegetation and are therefore well suited for treating runoff from roads, highways and impervious surfaces. When properly incorporated into a stormwater treatment design, grass swales help to reduce impervious cover, accent the natural landscape and provide aesthetic benefits.

Examples:

- Roadside ditch.

Design Notes:

- Ditch Slopes 0.5-6%, Side slopes no greater than 1:3
- Good addition to a combined STF system
- Relatively low maintenance STF

7.C.3 Infiltration Trench

The infiltration trench is an excavated trench 3 to 8 ft. deep, backfilled with rock or stone aggregate and lined with filter fabric. This practice temporarily stores small water quality volumes and allows it infiltrate into the soil over a prescribed period. The WQV passes through a combination of pretreatment measures (vegetated filter strip, vegetated swale, sediment forebay, etc.) and into the infiltration trench, creating an underground reservoir for the runoff. The runoff gradually infiltrates through the bottom and sides of the trench and eventually reaches the underground water table.

Examples:

- Series of trenches cut across the roadside ditch or median at defined intervals
- At the outlet of a flume or small storm sewer system (one to three inlets)
- Along the edge of a parking area or development

Design Notes:

- Recommended in soils with a minimum infiltration rate of 0.5 in/h
- Underdrains can be incorporated in soils with low permeability
- Depth to water table must be considered
- Maintenance is variable
- Most effective for smaller drainages (<5 acres)

7.C.4 Infiltration Basin

An infiltration basin is an excavated impoundment with no primary outlet that captures and temporarily stores larger water quality volumes until it can infiltrate into the soil over a prescribed period. The basin has a flat floor with an optional underdrain system to allow draining in the event of standing water. A secondary outfall may be provided to pass higher volumes of flow.

Examples:

- Basin at the end of larger storm sewer system or extended length of ditch
- Widened and flattened section of ditch with amended soils
- Capture runoff from edge of facilities (rest areas, maintenance yards, etc)

Design Notes:

- Pre-treatment is recommended to avoid premature clogging of the system
- Typically serves drainage areas from 5-10 acres (20 acres if offline)
- Recommended in soils with a minimum infiltration rate of 0.5 in/h.
- Secondary or emergency outlet should be incorporated
- Depth to water table must be considered
- Regular maintenance is required

7.C.5 Bioretention

The bioretention STF is a shallow stormwater basin or landscaped area that utilizes engineered soils and vegetation to capture and treat runoff. Stormwater runoff is temporarily ponded within the basin and seeps through the engineered soils. The biomass in the system retains nutrients and other pollutants, and the stormwater is filtered through the surface vegetation, mulch layer, and pervious soil layer. The filtered stormwater is then either allowed to infiltrate in to the surrounding soils, or more commonly, discharged through an aggregate base layer and perforated pipe sub-drain.

Examples:

- Curb cut into rain garden
- A series of offline plantings adjacent to the roadside ditch
- Sections of or the entire length of a median
- At the outlet of a flume or small storm sewer system (one to three inlets)
- Along the edge of a parking area or development

Design Notes:

- Pre-treatment is optional but recommended
- Depth to water table must be considered
- Incorporate an underdrain system
- Regular maintenance is required

7.C.6 Media Filter

A media filter is a structural stormwater STF system that temporarily stores stormwater runoff and passes it through a filter bed of sand or other filtering media. The system usually consists of two chambers. The first is the sediment forebay or sedimentation chamber, which collects and allows heavier sediment to settle. The second is the filtration chamber, which filters the runoff through a bed of sand or other filtering media. An underdrain is used to return the filtered runoff to the conveyance system or other receiving waters.

Examples:

- An underground vault associated with a storm sewer system in ultra-urban location
- An open air vault or basin located at the end of a culvert/storm sewer system
- A ditch check with a sand filled drain

Design Notes:

- Pre-treatment is recommended
- Permeability of filtering media controls design
- Regular maintenance required
- Typically serves drainage areas up to 2 acres (5 acres if offline)

7.C.7 Extended Dry Detention

The extended dry detention facility is designed to temporarily store the WQV, and slowly release it to receiving waters. This allows the suspended solids in the stormwater enough time to settle out of suspension. Stormwater flows are collected in the shallow basin and constricted by an outlet structure to produce low flow rates calculated to delay the drawdown of the basin over a 24 to 48 hour (72 hour maximum) period. Extended detention basins are typically end-of-system STFs designed to limit the impact of a site's stormwater discharge on downstream property and receiving waters.

Examples:

- Basin at the end of larger storm sewer system or extended length of ditch
- At the outlet of a flume or small storm sewer system
- Along the edge of a parking area or development

Design Notes:

- Pre-treatment forebay may improve performance and lower maintenance frequency
- Outlet control structures determine the extent of detention/retention and treatment
- Appropriate basin size and outlet design are critical to the effectiveness of these systems
- Typically serves larger drainage areas (>5 acres)
- Regular maintenance is required

7.C.8 Wet Detention Pond

A wet detention pond is designed to intercept stormwater runoff, temporarily impound that runoff and release it at a reduced rate to the receiving stream or stormwater system. Wet detention ponds use a permanent pool of water to aid in achieving water quality control. The pool may cover the entire pond bottom or may be located in only a portion of the pond. A wet detention pond can be used to reduce the post-development discharge to that of the pre-development rate under the 2-year, 10-year and 100-year event storms and can provide relatively good water quality improvement along with rate control. Stormwater runoff entering the pond intermixes with the standing pool reducing the sediment concentration and diluting the dissolved constituents. Effectiveness of the Wet Detention Pond is dependent on the size of the standing pond relative to the water quality volume.

Examples:

- Pond at the end of larger storm sewer system
- At the ends of ditches with larger drainage areas
- Pond located at the end of midsize culverts
- Located on small flowing drainages

Design Notes:

- Design outlet control structures for both WQV and larger detention and determine the extent of detention/retention and treatment.
- Basin size and outlet design are critical to the effectiveness of these systems
- Extended wet detention ponds typically detain water for 24-48 hours to provide settling of particulates.
- Requires larger drainage areas (10 acres minimum)
- Pre-treatment forebay may improve performance and lower maintenance frequency

7.C.9 Stormwater Wetland

A stormwater wetland is a constructed wetland planted with emergent vegetation to treat stormwater. Stormwater wetlands can also function in reducing the peak discharge of storm events by providing temporary water storage above the normal pool elevation. Stormwater treatment is achieved by settling of particulates and biological uptake by the wetland vegetation. Stormwater wetlands are among the most effective STFs for pollutant removal while providing aesthetic and wildlife benefits with relatively low maintenance costs.

Examples:

- Basin at the end of larger storm sewer system
- At the ends of ditches with larger drainage areas
- Pond located at the end of midsize culverts
- Located on low flow drainages

Design Notes:

- Relatively large contributing drainage area is required to maintain an adequate water source (10 acres minimum)
- Forebay should be incorporated to decrease velocity and reduce sediment loading
- Wetland should be designed with varied depths to support a diverse range of vegetation
- High maintenance requirements during the first couple years while vegetation is establishing

7.C.10 Pervious Pavement

Pervious pavement systems allow the infiltration of stormwater runoff through a pavement surface into an aggregate base. The aggregate base provides temporary storage of captured rainfall where it then infiltrates into underlying soils or is collected by an underdrain. It also provides the structural and functional features needed for the roadway, parking lot or sidewalk. The paving surface, subgrade and installation requirements of porous pavements are more complex than those for conventional asphalt or concrete surfaces.

Examples:

- Potential applications in low volume traffic areas such as rest areas, maintenance yards, weigh stations, etc.
- Other uses include emergency stopping areas, traffic islands, sidewalks, road shoulders, vehicle cross-overs on divided highways, and low-traffic roads

Design Notes:

- Generally not suited for areas with high traffic volumes or loads
- Requires underdrain system
- Regular maintenance is necessary to reduce the potential for clogging

7.C.11 Proprietary Structural Treatment Control

Proprietary Structural Treatment Control are commercially available, often prefabricated units, designed and sized for stormwater treatment by the manufacturer based on criteria provided. These systems treat stormwater in various ways ranging from mechanisms to enhance particle settling to oil and water separation. Some devices use settling and surface oil separation mechanisms, whereas others use filtration or vortex motion separating mechanisms. Structural treatments may be placed online or offline depending on manufactures specifications.

Examples:

- Catch basin insert
- Oil/grit separators built into the inlet structure
- Hydrodynamic separator

Design Notes:

- Used as pre-treatment in storm sewer systems
- Particularly suitable for ultra-urban environment
- Size dependent upon the amount of stormwater needing treatment
- High maintenance STF

7.C.12 Other Reasonable Practices

Stormwater management is an evolving field and STFs will need to be updated as technologies advance and research provides additional information. If a designer would like to incorporate a treatment device not described in this chapter, please contact **RDC** for approval.

NDOT STF Suitability Matrix										
STF	Description	Treatment Type	Typical Drainage Area	Site Suitability	Soil Permeability	Groundwater Limitations	Best at Removing...	Construction Cost	Maintenance Cost	Comments
Vegetated Filter Strips	Densely vegetated strip of land designed to treat street flow	Water Quality Treatment Rate	Based on Sheet Flow Loading	Rural and Urban Section	Any (with soil conditioning)	≥ 2 feet	Suspended Solids	Low	Low	Maximum slope generally 6H:1V - longer filter strip needed on steeper slopes
Grass Swale	Densely vegetated drainage way designed to convey runoff slowly to allow for treatment	Water Quality Treatment Rate	≤ 5 acres	Rural and Urban Section	Any (with soil conditioning)	≥ 2 feet	Suspended Solids, Heavy Metals, Hydrocarbons	Low	Low	Limited depth of flow and velocity for effective treatment
Infiltration Trench	Aggregate-filled trench designed to capture runoff in the void space and infiltrate it.	Water Quality Volume	≤ 5 acres	Rural and Urban Section	0.5 - 12 in/hr	≥ 4 feet	Suspended Solids, Nutrients, Heavy Metals	Moderate-High	Moderate	Width of Trench ≥ Depth
Infiltration Basin	Shallow basin designed to capture runoff above ground and infiltrate it through natural soils	Water Quality Volume	10-20 acres	Rural and Urban Section	0.5 - 12 in/hr	≥ 4 feet	Suspended Solids, Nutrients, Heavy Metals, Hydrocarbons	Moderate	Moderate	Drainage area limited if constructed on line
Bioretention Basin	Shallow basin designed to capture runoff above ground and infiltrate it through an amended soil zone with underdrain	Water Quality Volume	≤ 5 acres	Rural and Urban Section	0 - 12 in/hr	≥ 4 feet	Suspended Solids, Heavy Metals	Moderate	Moderate	Landscape plantings typical with this BMP
Media Filter	Structure that includes a sedimentation chamber and sand filtration chamber to treat runoff	Water Quality Volume	≤ 2 acres	Urban and Ultra-Urban	Any	n/a	Suspended Solids	High	High	Typically a cast-in-place structure - check hydraulic grade lines and possibly buoyancy issues
Extended Dry Detention	Dry basin designed to capture runoff with drawdown to the basin bottom over an extended period	Water Quality Volume	≤ 5 acres	Rural and Urban Section	0 - 12 in/hr	0	n/a (see comments)	Low	Low	Only moderate treatment efficiency in general
Wet Detention	Basin with permanent pool of water designed to capture runoff with drawdown to the normal pool elevation over an extended period	Water Quality Volume	10 acres + (typ)	Rural and Urban Section	Depends on Design	Depends on Design	Suspended Solids	Low	Low	Minimum drainage area needed to maintain permanent pool
Stormwater Wetland	Basin or drainage way with a pool of water of varying depths designed to support wetland vegetation and treat water flowing through the system	Water Quality Volume	10 acres + (typ)	Rural and Urban Section	Depends on Design	Depends on Design	Suspended Solids, Heavy Metals	Moderate	Moderate	Minimum drainage area needed to maintain wetland
Pervious Pavement	Various types of pavement with the ability to pass stormwater through the surface to an underlying aggregate bed - the aggregate bed is designed to capture runoff in the void space and release it slowly through an underdrain	Water Quality Volume	≤ 5 acres	Urban and Ultra-Urban	0 - 12 in/hr	≥ 4 feet	Suspended Solids, Heavy Metals, Hydrocarbons	High	High	Protect adjacent pavement
Proprietary Structural Treatment Controls	Various types of proprietary devices designed to treat stormwater runoff	Water Quality Treatment Rate (Typical)	≤ 2 acres	Urban and Ultra-Urban	Any	n/a	Varies	High	High	Approval of device needed - check hydraulic grade lines and possibly buoyancy issues

Exhibit 3.10 STF Suitability Matrix

8. COMPLETING STF DESIGN

During the “Final Design Phase” of the project (See the DPO, Ref. 3.1), the designer will complete the STF design. This will include finalizing the STF size, designing the discharge structure, and applying build notes, etc. The designer also addresses landscaping, construction, maintenance, and a number of miscellaneous items related to the STFs.

At the end of the public hearing phase the designer reviews and revises Form B. The **Unit Head** will then sign off on the completed form and forwards a copy to **RDC**. **RDC** will review the form along with final plans for the STF(s) during the erosion control plan review. The final stormwater treatment plans will be presented and discussed during Environmental Coordination Meeting 40.

8.A Landscaping

The final landscape plan will be completed by **RDC** and provided to the designer for inclusion with project plans. The landscape plan will include the planting scheme necessary to provide both functional and aesthetic value to the stormwater STFs.

8.B Construction Phasing

STFs are intended to be operational when a project is completely stabilized. This eliminates the potential for early failure due to sedimentation during the vegetation establishment period of the site. The following three options are available to a designer for phasing construction of STFs:

- Option 1 – STF is constructed as the project is built and is isolated from stormwater flows until the Treatment Drainage Area is completely stabilized
- Option 2 – STF is partially constructed with the project and utilized as a temporary sediment control measure until the Treatment Drainage Area is completely stabilized
- Option 3 – STF is constructed after its Treatment Drainage Area is completely stabilized

The designer documents on Form B, which option(s) is appropriate for each selected STF. Phasing will also need to be documented on the construction plans or by special provision. Phasing decisions are made in consultation with the **District**.

8.C Maintenance Schedule

Maintenance schedules for each STF are provided in the Design Guides provided in Appendix P. If a designer has a maintenance requirement that differs from those provided in the STF Design Guide, he/she needs to document them on Form B. **RDC** will utilize that information and the schedules in the Design Guides to complete “Stormwater Treatment within MS4 Communities / Form C – Maintenance” (Form C), included in Appendix Q. **RDC** will forward Form C to the **Operations Division**.

8.D Plan Labeling of STF

The designer must coordinate the labeling of the STFs on the design plans (See Section 7.A.6.a). Label STFs on both design plans and ROW plans as a “Stormwater Treatment Facility” followed by the specific STF title. STF titles are given in the STF Design Guidelines in Appendix P.

For example: a sand filter used as a STF will be labeled as “Stormwater Treatment Facility – Sand Filter”.

8.E Miscellaneous

8.E.1 Fencing

The majority of STFs will be located along highways within urbanized areas. With this in mind the designer may choose to include fencing around the STF to limit access by the general public. This may be of particular importance on STFs which pond water more than a foot deep. The **Unit Head** will review the use of fencing and request approval from the **District**.

8.E.2 Signage

In addition to stormwater treatment, the MS4 permit requires the **NDOT** to implement a stormwater education program. The use of STFs may provide the **NDOT** with an outreach opportunity to showcase environmental commitments. This could be accomplished by placing a sign adjacent to a STF that explains how the measure functions to provide water quality benefits. **RDC** will coordinate with the designer and the **Traffic Engineering Division** to determine if sign(s) are feasible and what information should be included.

9. REFERENCES

- 3.1 Nebraska Department of Transportation, Design Process Outline (DPO), Current Edition.
(<http://dot.nebraska.gov/media/6761/design-process-outline.pdf>)
- 3.2 United States Environmental Protection Agency, National Management Measures to Control Nonpoint Source Pollution from Urban Areas, Washington, D.C., November 2005
- 3.3 Nebraska Department of Transportation, Roadway Design Manual, Current Edition
(<http://dot.nebraska.gov/business-center/design-consultant/rd-manuals/>)