

DEVELOPMENT AND EVALUATION OF BEST MANAGEMENT PRACTICES (BMPS) FOR HIGHWAY RUNOFF POLLUTION CONTROL

Project Number: SPR-1(12)M314



December 31, 2013



**DEVELOPMENT AND EVALUATION OF BEST
MANAGEMENT PRACTICES (BMPS) FOR HIGHWAY
RUNOFF POLLUTION CONTROL**

Nebraska Department of Roads (NDOR)

Project Number: SPR-1(12)M314

FINAL REPORT

PRINCIPAL INVESTIGATORS

Tian C. Zhang, John Stansbury and Massoum Moussavi

SPONSORED BY

Nebraska Department of Roads

December 31, 2013

TECHNICAL REPORT DOCUMENTATION PAGE

1. Report No. SPR-P1(12) M314	2. Government Accession No.	3. Recipient's Catalog No.	
1. Title and Subtitle DEVELOPMENT AND EVALUATION OF BEST MANAGEMENT PRACTICES (BMPS) FOR HIGHWAY RUNOFF POLLUTION CONTROL		2. Report Date December, 31 2013	
		3. Performing Organization Code	
4. Author(s) Tian C. Zhang, John Stansbury, Massoum Moussavi, Daniel Jones and Dana L. Richter-Egger		5. Performing Organization Report No.	
6. Performing Organization Name and Address Department of Civil Engineering University of Nebraska-Lincoln Omaha, Nebraska 68182-0178		7. Work Unit No.	
		8. Contract or Grant No.	
9. Sponsoring Agency Name and Address Nebraska Department of Road P.O. Box 94759 Lincoln, NE 68509-4759		10. Type of Report and Period Covered Final Report	
		11. Sponsoring Agency Code	
12. Supplementary Notes			
13. Abstract Polluted storm water runoff is commonly transported through Municipal Separate Storm Sewer Systems (MS4s). Currently, sufficient information is not available on development and evaluation of Best Management Practices (BMPs) within an MS4 boundary for highway storm water runoff treatment and management. The objectives of this research were to: a) develop and test the feasibility of roadside BMPs that rely on bioretention, infiltration, and slow conveyance of storm water; b) test combinations of plants and soil media that will be sustainable in Nebraska; and c) test the feasibility of using rubber chips as an alternative BMP medium. This project was conducted in two phases. In Phase I (07/2011–12/2012), four field-scale BMPs were designed, constructed and monitored, and four types of rubber chip mediated soil mixtures were tested in bench-scale columns for physical properties related to plant growth and infiltration as well as storm water treatment effectiveness. In Phase II (01/2013–12/2013), the four field-scale BMPs were monitored. In Phase I, it was found that a 50/50 mixture of rubber chips and sand had the best treatment, but lacked the best qualities for plant growth and may require addition of compost. The benefit of adding rubber chips as a low cost alternative material for filler did not outweigh the leaching of lead, copper and zinc. In Phase II, field tests indicate that the bioretention cells with the 30% loam 50% sand 20% mulch mix and with the 50% compost 50% sand mix had good vegetative growth and good physical characteristics to support vegetative growth and establishment. The infiltration trench had minimal sediment interception and clogging but showed slow drawdown times in the spring months. The filter trench had variable TSS removal percentages, with the side slope of the filter trench contributing a large amount of the solids loading. The check dam filters experienced significant sediment accumulation after the first storm event. However, it was found that drawdown times were still within the range for operation. The four BMPs tested are all functional and feasible for treatment of highway storm water runoff, with bioretention cells being the cheapest to construct (\$0.91* ft ³ of water quality volume of the watershed). Results obtained from this two-phase project can be used to design and build field-scale BMPs in eastern Nebraska (e.g., areas near Omaha and Lincoln).			
14. Keywords: BMP, stormwater, Nebraska, roadside, MS4		15. Distribution Statement	
16. Security Classification (of this report) Unclassified	17. Security Classification (of this page)Unclassified	18. 248 Pages	22. Price

DISCLAIMER

The contents of this report reflect the views of the authors who are responsible for the facts and the accuracy of the data presented herein. The contents do not necessarily reflect the official views or policies of the Nebraska Department of Roads, nor of the University of Nebraska-Lincoln. This report does not constitute a standard, specification, or regulation. Trade or manufacturers' names, which may appear in this report, are cited only because they are considered essential to the objectives of the report. The United States (U.S.) government and the State of Nebraska do not endorse products or manufacturers.

ACKNOWLEDGEMENTS

This project was sponsored by the Nebraska Department of Roads (NDOR) and the University of Nebraska-Lincoln. The support of the technical advisory committee (TAC) members is gratefully acknowledged as well as the NDOR Roadway Design and hydraulics Divisions design team.

EXECUTIVE SUMMARY

As non-point source pollution, storm water runoff is one of the main contributors to stream impairment in the United States. The United States Environmental Protection Agency (USEPA) requires Municipal Separate Storm Sewer Systems (MS4s) to obtain a permit under the National Pollution Discharge Elimination System (NPDES) to manage this pollution. Many municipalities and non-traditional MS4s such as the Nebraska Department of Roads are under federal regulations that require new developments or redevelopments of a certain size to capture (and treat) runoff from all new impervious surfaces (roofs, driveways, sidewalks, and so forth) onsite, instead of allowing it to run into the sewers or nearby waterways. To do this structural Best Management Practices (BMPs) are often used to treat the first half-inch of runoff which is commonly considered to contain the majority of pollutants from those sites.

The goal of this project was to develop and evaluate BMPs that rely on bioretention, infiltration, and slow conveyance of stormwater for highway runoff pollution control. This project was conducted in two phases:

- **Phase 1** (07/2011 and 12/2012) was about design/construction/preliminary monitoring of four different field-scale BMPs, and testing laboratory-scale bioretention cells filled with four types of rubber chip mediated soil mixtures.
- **Phase 2** (01/2013 and 12/2013) was about monitoring of the performance of the four field-scale BMPs and evaluation of the feasibility of the developed BMPs.

This report contains two parts, with PART I: DESIGN/CONSTRUCTION OF BMPS AND

LABORATORY STUDIES for Phase I studies, and PART II: CONTINUOUS MONITORING FOR PHASE II STUDIES.

The specific objectives of Phase I studies were to: 1) find the combinations of plants and soil media that will be sustainable for MS4 BMPs used in Nebraska; and 2) test the feasibility of using rubber chips (density = $\sim 40 \text{ kg/m}^3$) as the porous media in bioretention systems. In Phase I, four field-scale BMPs, i.e., 1) check dam filters, 2) bioretention cells, 3) infiltration trench, and 4) filter trench, were designed, constructed, and monitored. In addition, four types of rubber chip mediated soil mixtures were tested in bench-scale bioretention cells.

It was found that a 50/50 mixture of rubber chips and sand had the best treatment, but lacked the best qualities for plant growth and may require addition of compost. The benefit of adding rubber chips as a low cost alternative material did not outweigh the leaching of lead, copper and zinc. Also the rubber chips did not add any significant physical benefit to the media such as improving growth-limiting bulk density, moisture holding capacity, or available moisture.

The specific objectives of Phase II studies were to: 1) monitor the performance of field-scale BMPs; and 2) evaluate the feasibility of the developed BMPs for field-scale application. Activities in Phase II studies included: 1) monitoring plant establishment, growth, and sustainability; 2) evaluation of the performance of BMPs and BMP conditions in general by monitoring each BMP for erosion/rill development, sedimentation, and clogging of the medium and by taking core samples/site pictures and testing infiltration rates; 3) collection of general information on weather conditions, storm events,

maintenance issues; 4) linking the performance of lab-scale BMPs with the field-scale BMPs to improve our understanding of design and monitoring procedures of BMPs; and 5) cost estimation of BMP construction and operation.

Results of Phase II studies indicate that the bioretention cells with the 30% loam 50% sand 20% mulch mix and with the 50% compost 50% sand mix had good vegetative growth and good physical characteristics to support vegetative growth and establishment. The infiltration trench had minimal sediment interception and clogging because of low sediment loading to the BMP, but showed slow drawdown times in the spring months likely due to underlying clay soils. The filter trench had a TSS percent removal ranging from -275% to about 75%, with negative representing leaching or a net increase in TSS. The side slope of the filter trench contributed some solids loading due to inadequate site stabilization during construction. The check dam filters experienced significant sediment accumulation after the first storm event as the disturbed soil was not stabilized after the construction. However, drawdown times were still within the range for operation.

Combining the results of Phases I and II, it can be concluded that: 1) construction periods should be kept as short as possible to minimize the chance of rain events during construction. After the construction phase, erosion control measures should be placed and maintained as soon as possible until the contributing watershed is stabilized with vegetation; 2) the four BMPs tested are all functional and feasible for treatment of highway storm water runoff, with bioretention cells being the cheapest ($\$0.91 \text{ * ft}^3$ of water quality volume of the watershed); 3) in bioretention cells, media should be layered with the top layer or root zone focusing on plant establishment characteristics and the

continuing depth focusing on filtration and treatment of storm water constituents; and 4) a good initial understanding of the BMP media could be achieved via the preliminary lab-scale tests of the media. Results obtained from this project can be used to design and build field-scale BMPs in eastern Nebraska (e.g., areas near Omaha and Lincoln).

**DEVELOPMENT AND EVALUATION OF BEST MANAGEMENT PRACTICES
(BMPS) FOR HIGHWAY RUNOFF POLLUTION CONTROL**

PART I

DESIGN/CONSTRUCTION OF BMPS AND LABORATORY STUDIES

Table of Contents

Table of Contents	xii
List of Tables	xiii
List of Figures	xv
Chapter 1 Introduction	1
1.1 Background	1
1.2 Objectives and Organization of Part I of the Report.....	4
Chapter 2 Design and Monitoring of Field-scale Roadside BMPs.....	6
2.1 Introduction.....	6
2.2 Methods and Materials.....	8
2.2.1 Hydrology	8
2.2.2 BMP Design.....	13
2.2.3 BMP Materials and Soil Media.....	29
2.2.4 Monitoring Methods Used	34
2.3 Results and Discussions	38
2.4 Conclusions.....	55
Chapter 3 Lab Testing of Rubber Chip Mediated Soil Mixtures.....	56
3.1 Introduction.....	56
3.2 Materials and Methods.....	57
3.3 Results and Discussions	64
3.3.1 Initial Settling.....	64
3.3.2 Saturated Hydraulic Conductivities	65
3.3.3 Other Four Important Physical Characteristics of Media	67
3.3.4 Column Tests by Loading Synthetic Highway Storm Water Runoff	74
3.3.5 Discussion	86
3.4 Conclusions.....	89
Chapter 4 Conclusions and Recommendations.....	91
4.1 Conclusions.....	91
4.2 Recommendations.....	92
References	94
Appendix A Design Information on the Four BMP Sites with a Design Example	98
Appendix B Field Photos and Vegetative Monitoring.....	102

Appendix C QA/QC.....	114
Appendix D Lab Reactor Graphs.....	132

List of Tables

Table 2.1 Hydrologic soil groups (Gupta 2008)	10
Table 2.2 Numbers for various land uses and conditions (NRCS 1986)	11
Table 2.3 Suggested minimum design frequency and spread (FHWA 2009)	12
Table 2.4 Runoff coefficients for rational method (NDOR 2006).....	15
Table 2.5 Example table of WQV and peak discharges	17
Table 2.6 Geometric elements of trapezoidal cross section.....	22
Table 2.7 Typical spacing of riprap check dams placed for velocity and erosion control (MPCA 2000).....	24
Table 2.8 Sieve design specification for ASTM C33 grout sand	32
Table 2.9 Physical and chemical properties of compost used in engineered soil mixtures	32
Table 2.10 Sieve design specification for ASTM C33 47-B gravel	33
Table 2.11 Aggregates used in test BMPs	34
Table 2.12 Seed mixture for Nebraska region B (NDOR 2010).....	36
Table 2.13 Rainfall amounts in 2012 for both project sites (NCDC 2012)	37
Table 2.14 Estimated BMP construction time period.....	38
Table 2.15 Percent of image that is green from Image J analysis.....	48
Table 2.16 Four BMPs tested advantages and disadvantages.....	52
Table 2.17 General recommendations of the four BMPs.	53
Table 2.18 Site visit criteria and methods.....	54
Table 3.1 Synthetic storm water constituents and concentrations (Keblin et al. 1998)....	58
Table 3.2 Constituents, methods, and method detection limits	62
Table 3.3 Initial settling of reactor media.....	65
Table 3.4 Typical hydraulic conductivities (Gupta 2008)	66
Table 3.5 Initial saturated hydraulic conductivity	67
Table 3.6 Final saturated hydraulic conductivity.....	68
Table 3.7 Difference in initial and final saturated hydraulic conductivity	68
Table 3.8 Saturated hydraulic conductivity after replacement of top 2.5" of media	69
Table 3.9 Difference in saturated hydraulic conductivity before and after replacing the top 2.5 inches of media	69
Table 3.10 Physical characteristics of media tested.....	70

Table 3.11 NDEQ stream standard concentrations (NDEQ 2006).....	74
Table 3.12 Concentrations of constituents in tap water and roadway sediment.....	75
Table 3.13 Roadway constituent sources (Stansbury et al. 2012)	76
Table 3.14 Iron concentrations (in $\mu\text{g/L}$) in influent and effluent of columns	77
Table 3.15 Iron treatment efficiencies (%) of different columns.....	77
Table 3.16 Nickel concentrations (in $\mu\text{g/L}$) in influent and effluent of columns	78
Table 3.17 Nickel treatment efficiencies (%) of different columns.....	78
Table 3.18 Copper concentrations (in $\mu\text{g/L}$) in influent and effluent of columns	79
Table 3.19 Copper treatment efficiencies (%) of different columns	80
Table 3.20 Zinc concentrations (in $\mu\text{g/L}$) in influent and effluent of columns.....	81
Table 3.21 Zinc treatment efficiencies (%) of different columns.....	82
Table 3.22 Lead concentrations (in $\mu\text{g/L}$) in influent and effluent of columns	82
Table 3.23 Lead treatment efficiencies (%) of different columns	83
Table 3.24 Nitrate concentrations (in $\text{mg NO}_3\text{-NO}_3\text{/L}$) for reactors.....	84
Table 3.25 Nitrate treatment efficiencies (%) of different columns	85
Table 3.26 TSS concentrations (in mg/L) in influent and effluent of columns	85
Table 3.27 Total suspended solids treatment efficiencies (%) of different columns.....	86
Table 3.28 COD concentrations (in mg-O/L) in influent and effluent of columns	87

List of Figures

Figure 2.1 I street site location.....	7
Figure 2.2 Salt valley site location.....	8
Figure 2.3 Velocities for estimating travel time (Olsson Associates 2006)	14
Figure 2.4 Rainfall intensity-duration – Omaha, Nebraska	16
Figure 2.5 Salt valley bioretention cells profile view	18
Figure 2.6 Salt valley bioretention cells plan view	19
Figure 2.7 Infiltration trench cross section	20
Figure 2.8 Reference shape for Table 2.6	22
Figure 2.9 Cross section of filter trench.....	24
Figure 2.10 Typical riprap check dams cross and longitudinal sections (MPCA 2000) .	25
Figure 2.11 Variables used to calculate check dam volume (PSBMP 2006)	26
Figure 2.12 Check dam filter profile.....	27
Figure 2.13 Check dam filter cross section.....	28
Figure 2.14 Check dam filter plan	28
Figure 2.15 USDA-NRCS soil texture triangle	30
Figure 2.16 Nebraska seed mixture planting regions (NDOR 2012).....	37
Figure 2.17 Check dam filter clogging	40
Figure 2.18 Check dam filter gravel and clogging	40
Figure 2.19 Infiltration trench clogging.....	42
Figure 2.20 Filter trench side slope rills	43
Figure 2.21 Filter trench sediment buildup on armoring and check dams.....	44
Figure 2.22 Filter trench sediment buildup and vegetative growth	44
Figure 2.23 Filter trench undermining at beginning of trench.....	45
Figure 2.24 Filter trench added 1-3 inch rock at beginning and check dam material migration (water flow direction: from the top to bottom of the picture)	46
Figure 2.25 Filter trench undermining hole along trench	47
Figure 2.26 Percent of image that is green from Image J analysis	48
Figure 3.1 Reactor plans	59
Figure 3.2 Growth-limiting bulk density textural triangle.....	71
Figure 3.3 General relationship between soil moisture and texture (USDA 2008)	73
Figure 3.4 Effect of increasing organic matter on available water (USDA 2008)	73

Chapter 1 Introduction

1.1 Background

Storm water runoff from urbanized and agricultural land is a leading cause of impairment to lakes and estuaries in the United States (USEPA 1996). For highway storm water runoff, heavy metals, especially copper and zinc, total suspended solids (TSS), total dissolved solids (TDS), biological oxygen demand (BOD), and chemical oxygen demand (COD) are the primary contaminants of concern from the highway runoff (Stansbury et al. 2012).

Storm water discharges from Municipal Separated Storm Sewers Systems (MS4s) are regulated non-point source pollution. Non-point source pollution in MS4s comes from pollutants that are picked up from runoff and carried into the storm sewer system and ultimately into the nations waterways. These pollutants are from animal waste, fertilizers, cars, construction sites, etc. MS4 regulation is part of the Clean Water Act (CWA) which regulates discharges into United States navigable waters through the National Pollutant Discharge Elimination System (NPDES). MS4 regulation was implemented in two phases. Phase I was implemented in 1990 and regulates large municipalities. Phase I requires Storm Water Pollution Prevention Plans (SWPPP) to be submitted by the MS4s to the United States Environmental Protection Agency (USEPA). Phase II, implemented in 1999, regulates small municipalities. Phase II requires using 6 minimum Best Management Practices (BMPs) to treat storm water to the Maximum Extent Practicable (MEP), and no numerical effluent limits are placed through storm

water regulations. The six BMPs are a) public education and outreach, b) public participation and involvement, c) illicit discharge detection and elimination, d) construction site runoff control, e) post-construction runoff control, and f) pollution prevention and good house-keeping (CWA 1977a).

Currently, many municipalities and non-traditional MS4s such as the Nebraska Department of Roads (NDOR) are under federal regulations that require new developments or redevelopments of a certain size to capture (and treat) runoff from all new impervious surfaces (roofs, driveways, sidewalks, and so forth) onsite, instead of allowing it to run into the sewers or nearby waterways. Development of BMPs to manage and treat storm water before it arrives at storm sewer systems is a new challenge to these entities.

Considerable research on development of BMPs for highway storm water runoff treatment has been conducted since the 1990s (Kebelin et al. 1998; U.S. EPA 1999; MPCA 2000; Davis et al. 2001; Ming-Han et al. 2010; Stansbury et al. 2012; Vacha 2012). Some issues that need to be considered in roadside BMPs are driver safety, media compressibility and roadway stability.

Many of the roadside BMPs (e.g., bioretention, infiltration, and slow conveyance of storm water) rely on engineered soil media with high percolation rates being effective to prevent ponding of surface water in these BMPs. Several challenges (and thus knowledge gaps) related to these BMPs exist:

- These BMPs (e.g., infiltration trenches and bioretention) need a 2–3 foot thick layer of porous media; the conventional media (e.g., gravel or crushed rock) are

very expensive due to their high density. Finding a medium that has a low density, a long lifespan, and can recover its original volume after compression (e.g., due to car accidents or maintenance activities) is critical.

- Information is insufficient on what kinds of media are better to support plant growth in bioretention BMPs that are located in different geographic regions under varied environmental conditions.
- Information is lacking on the performance and evolution of physical conditions of the BMPs and on the procedures for monitoring and operation of these BMPs.

To fulfill the knowledge gap, Nebraska Department of Roads (NDOR) funded a research project “*Feasibility of Integrating Natural and Constructed Wetlands in Roadway Drainage System Design*” between 2009 and 2012. The project found that vegetated filter strips, vegetated swales, bioretention, sand filters, and horizontal filter trenches may be most applicable to highway storm water runoff treatment/management. When writing the design guide of these BMPs, several technical issues with knowledge gaps were identified, such as criteria for selection of soil media for different BMPs, relationships between soil media and plant growth, and evaluation of BMPs’ performance and monitoring/maintenance procedures of BMPs. In addition, there is a need to test different BMPs in Nebraska so that the aforementioned knowledge gaps can be filled.

In light of the aforementioned analysis, this project will focus on two major issues: i) the soil medium and vegetative growth and ii) use of alternative BMP media. The justifications of this focus are as follows. First, when a soil medium is used in these BMPs, creating a soil medium that drains at a desired rate, supports plant growth, and

treat storm water constituents are important design aspects. However, the combinations of plants and media that will be sustainable in the varied regions of Nebraska are unknown. Certain plant species have been shown to provide significant uptake of pollutants in a process called phytoremediation. This uptake is not universal for all species and all pollutants, so knowing the key species to use in a BMP could drastically improve its effectiveness.

Second, BMP material prices can be expensive due to their density, availability, and transportation costs. The use of rubber chips could be a possible medium because they are lightweight and availability. This would be an alternative low-cost and low-weight material that could be used as filter media so that it can lower the cost of transportation of materials and ultimately the construction cost of the BMPs.

1.2 Objectives and Organization of Part I of the Report

Objectives. In light of above analysis, the objectives of this research are to:

- 1) Design and test the feasibility of several types of roadside BMPs, focusing on bioretention, infiltration, and slow conveyance of storm water.
- 2) Test several types of bioretention soil mixtures and the plant establishment associated with those mixtures.
- 3) Test the feasibility of using rubber chips as an alternative BMP medium by testing lab bench-scale columns filled with different combinations of rubber chip mediated filter media.

Organization of Part I of the Report. There are four chapters of Part I of this report. Chapter 1 “Introduction” reviews the background of storm water regulations, BMPs and how these apply to roadside treatment of storm water. Chapter 2 “Design and Monitoring of Roadside BMPs” goes through the design of field-scale BMPs, materials and methods used in the field testing and monitoring of these roadside BMPs concerning their plant establishment, clogging, and general design and operation. The chapter presents the results of plant establishment in the bioretention cells, sediment buildup problems, and general monitoring scheme and also provides recommendations for future studies. Chapter 3 “Lab Testing of Tire Chip Mediated Soil Mixtures” describes the physical properties and storm water treatment properties of four rubber chip mediated soil mixtures; results and discussion of the best and worst medium for roadside application are presented. Chapter 4 “Conclusions and Recommendation” is a compilation of the conclusions drawn from Chapters 2 and 3 with recommendations for future research being provided.

Chapter 2 Design and Monitoring of Field-scale Roadside BMPs

2.1 Introduction

Four roadside BMP types were selected for testing at two locations (Lincoln and Omaha, Nebraska). The four types of BMPs tested were bioretention, infiltration trench, filter trench and check dam filters. To design these BMPs, soil conditions, site hydrology, and roadway design literature searches were done. Also, site constraints were evaluated before design as these constraints played a role on the type of BMPs that could be installed.

The first site selected was located at the I-Street on-ramp to interstate 80 in Omaha, Nebraska (Figure 2.1). At this site, four check dam filters were designed and installed. This site was chosen because it was easily accessible, had good site conditions for check dam filters, and was located in eastern Nebraska within the city of Omaha's MS4. The second site selected was located in Lincoln, Nebraska at NDOR's Salt Valley maintenance yard (5300 Salt Valley View St.) located near highway N-2 and 14th St. (Figure 2.2). At this site a set of bioretention cells, infiltration trench, and filter trench were installed. The bioretention cells were built here because a location with sufficient elevation change for under drain outlets was located where the bioretention cells could be built off-line of a ditch. The infiltration trench was installed here because a length of ditch was located on-site with a slope less than 3 percent which is required for infiltration trench structures. Lastly, a filter trench was installed at the Lincoln site because a ditch with erosion problems and a 6.5 percent slope was located on site. This was a good

location because it was hoped that the BMP could mitigate the scour erosion problem, and that the higher slope of the ditch would aid in the filter trench operation. The filter trench is a newly developed BMP type.

After the field-scale BMPs were designed and installed, monitoring methods were established for clogging, vegetation establishment, infiltration rates, and picture logs for progression of the BMPs. Monitoring of the check dam filters consisted of picture logging of the sediment buildup behind each dam. The bioretention cells were the primary focus for vegetation establishment and testing of four types of bioretention media. The infiltration trench was monitored for infiltration rates and general clogging. Finally, the filter trench as tested for general feasibility, design and treatment.

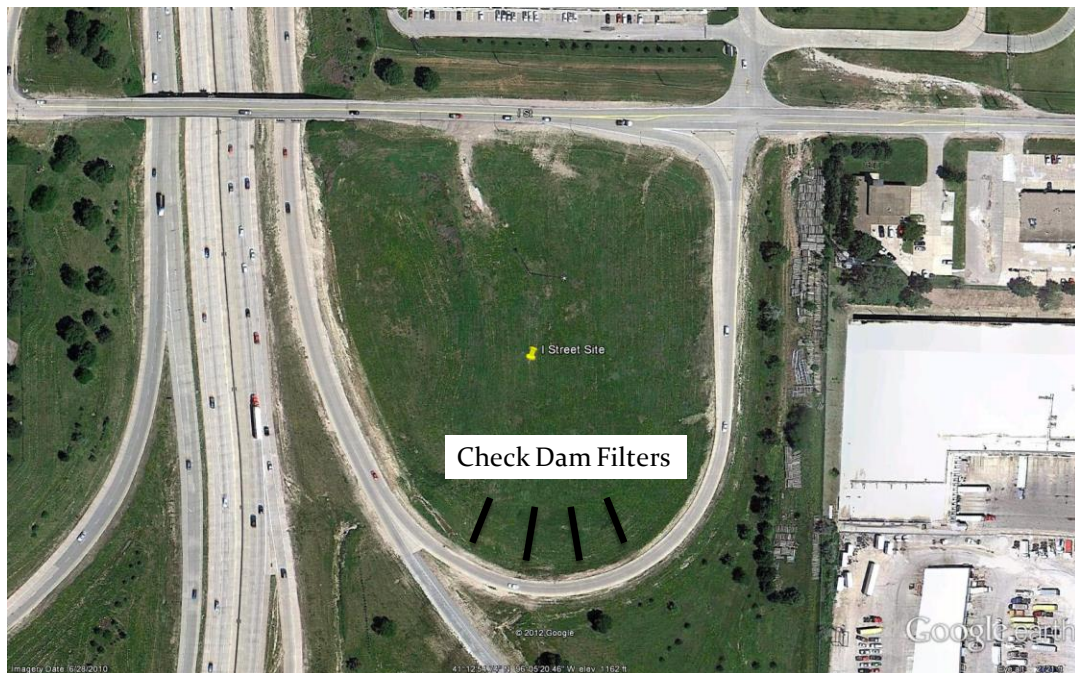

Figure 2.1 I street site location

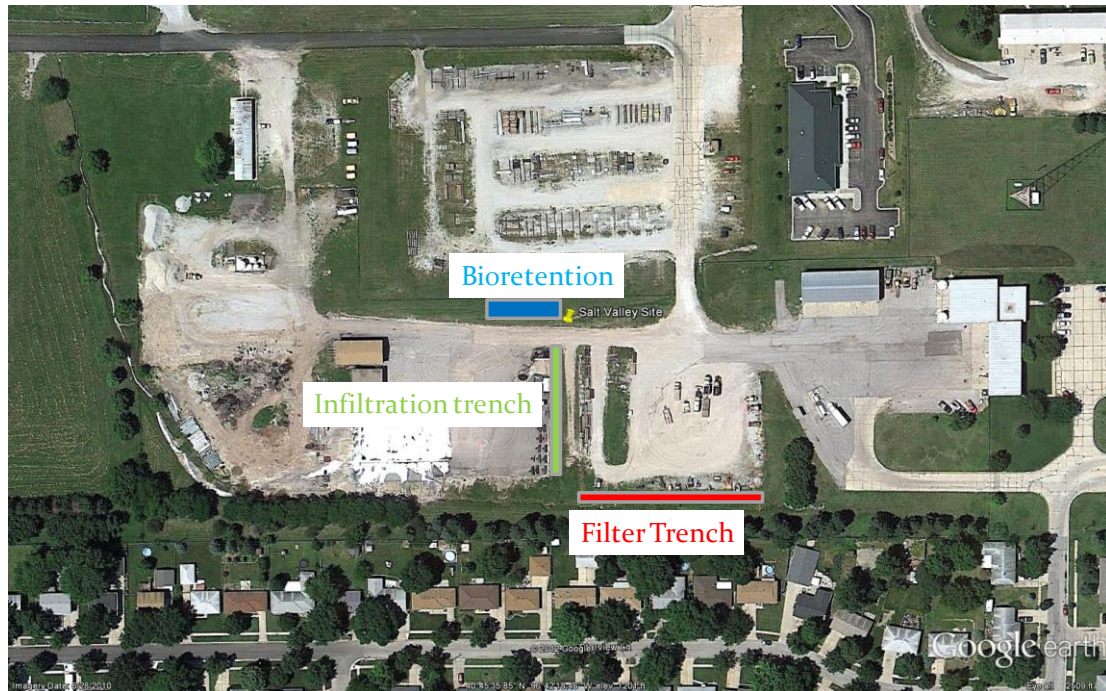

Figure 2.2 Salt valley site location

The objectives of this chapter are to 1) introduce the materials and methods used for the BMP designs, construction, and monitoring, and 2) present the results related to BMP performance and observations, and 3) provide recommendations for future studies.

2.2 Methods and Materials

2.2.1 Hydrology

The capture and treatment of the first 0.5 inches of runoff from new or redeveloped impervious areas is the motivation for the treatment of the water quality volume (WQV). The first 0.5 inches of runoff is known as the first flush. The first flush

or WQV is used as a treatment target volume because the first 0.5 inches of runoff contains 81–86% of the total pollutant mass (Flint and Davis 2007). The (pollutant-loaded) storm water that flows off the impervious area is considered runoff, while the storm water that is not from the new or redeveloped impervious area is considered run on. It is beneficial to keep run on and runoff separated because if they mix the total volume must be treated. Summing the WQV from runoff with the WQV from any run-on gives the total WQV that must be treated as shown in equation 2-1:

$$WQV_{Total} = WQV_{Run\ on} + WQV_{Runoff} \quad 2-1$$

where:

WQV_{Total} : Required Water Quality Volume to treat

$WQV_{Run\ on}$: Portion of the water quality volume added from pervious area and off property run off

WQV_{Runoff} : Water Quality Volume contributed from new or redeveloped impervious area

Calculating the design storm depth. The first step in the design process of the BMPs used was to calculate the design precipitation. The Natural Resource Conservation Service (NRCS) method was used to calculate the 0.5 inch runoff by using equation 2-2 (NRCS 1986):

$$Q = \frac{(P-0.2S)^2}{(P+0.8S)} \quad 2-2$$

where:

Q: Depth of runoff over the watershed (in or cm)

P: Precipitation (in or cm)

S: Potential maximum retention of water by the soil (in or cm)

To obtain 0.5 inches of runoff from impervious areas, the precipitation (P) in equation (2-2) equals 0.75 inches (Vacha 2012). Potential maximum retention, S is linked with the curve number (CN) by Eq. 2-3:

$$CN = \frac{1000}{10+S} \quad 2-3$$

To find CN, the hydraulic soil group must be chosen from Table 2.1, and the land use must be decided from Table 2.2.

Table 2.1 Hydrologic soil groups (Gupta 2008)

Group	Minimum Infiltration Rate (in/hr)	Texture
A	0.3–0.45	Sand, loamy sand, or sandy loam
B	0.15–0.3	Silt loam or loam
C	0.05–0.15	Sandy clay loam
D	0–0.05	Clay loam, silty clay loam, sandy clay, silty clay, or clay

From equations 2-2 and 2-3 and Tables 2.1 and 2.2 the precipitation depth of 0.75 inches obtains the 0.5 inches of runoff depth from impervious areas. The 0.75 inch depth storm should also be used to calculate any run-on that may mix with runoff and enter the BMPs. The resulting depth found from these NRCS methods is then multiplied by each respective sub watershed area to calculate the volume of runoff or run-on.

Table 2.2 Numbers for various land uses and conditions (NRCS 1986)

Description of Land Use	Hydrologic Soil Group			
	A	B	C	D
Paved parking lots, roofs, driveways	98	98	98	98
Streets and Roads:				
Paved with curbs and storm sewers	98	98	98	98
Gravel	76	85	89	91
Dirt	72	82	87	89
Cultivated (Agricultural Crop) Land:				
Without conservation treatment (no terraces)	72	81	88	91
With conservation treatment (terraces, contours)	62	71	78	81
Pasture or Range Land:				
Poor (<50% ground cover or heavily grazed)	68	79	86	89
Good (50–75% ground cover; not heavily grazed)	39	61	74	80
Meadow (grass, no grazing, mowed for hay)	30	58	71	78
Brush (good, >75% ground cover)	30	48	65	73
Woods and Forests:				
Poor (small trees/brush destroyed by over-grazing or burning)	45	66	77	83
Fair (grazing but not burned; some brush)	36	60	73	79
Good (no grazing; brush covers ground)	30	55	70	77
Open Spaces (lawns, parks, golf courses, cemeteries, etc.):				
Fair (grass covers 50–75% of area)	49	69	79	84
Good (grass covers >75% of area)	39	61	74	80
Commercial and Business Districts (85% impervious)	89	92	94	95
Industrial Districts (72% impervious)	81	88	91	93
Residential Areas:				
1/8 Acre lots, about 65% impervious	77	85	90	92
1/4 Acre lots, about 38% impervious	61	75	83	87
1/2 Acre lots, about 25% impervious	54	70	80	85
1 Acre lots, about 20% impervious	51	68	79	84

When evaluating a mixed-use watershed, runoff and run-on, curve numbers, C values, rainfall depths, and 10-year discharges should be calculated separately for each sub-watershed and then totaled for the whole watershed. This method is more conservative compared to using a weighted/composite curve number for BMP design.

Peak flow rate calculations. The peak flow rate from a 10-year return period storm was used in the design of roadside BMPs. The 10-year return period storm is the

minimum design frequency commonly used for drainage of roadways recommended by the Federal Highway Administration (see Table 2.3). The rational method is widely used in storm water design and in highway drainage design. To calculate the peak flow the rational method is used based on equation 2-3 (FHWA 2009; NDOR 2006).

$$Q = CIA \quad 2-4$$

where:

Q: Peak flow (cfs)

C: Rational Method Dimensionless runoff coefficient

I: Average rainfall intensity for a duration equal to the time of concentration, for a selected return period (in/hr)

A: Drainage area (acres)

Table 2.3 Suggested minimum design frequency and spread (FHWA 2009)

Road Classification		Design Frequency	Design Spread
High Volume or Divided or Bi- Directional	< 70 km/hr (45 mph)	10-year	Shoulder + 1 m (3 ft)
	> 70 km/hr (45 mph)	10-year	Shoulder
	Sag Point	50-year	Shoulder + 1 m (3 ft)
Collector	< 70 km/hr (45 mph)	10-year	½ Driving Lane
	> 70 km/hr (45 mph)	10-year	Shoulder
	Sag Point	10-year	½ Driving Lane
Local Streets	Low ADT	5-year	½ Driving Lane
	High ADT	10-year	½ Driving Lane
	Sag Point	10-year	½ Driving Lane

Before the rainfall intensity can be determined, the time of concentration must be calculated by using the most hydraulically remote sub-basin travel time in equation 2-5 to

decide the duration of the design storm. For time of concentrations of less than 5 minutes a value for t_c equal to 5 minutes is used.

$$t_c = \frac{L}{V} \quad 2-5$$

where:

t_c : Time of concentration (seconds)

L: Length of land use type (ft)

V: Water velocity from Figure 2.3 based on land slope (ft/s)

The C values for equation 2-4 can be found in Table 2.4 (NDOR 2006), and the rainfall intensity duration frequency curve for Omaha, NE is found in Figure 2.4. Table 2.5 shows calculation examples for WQV and peak discharges. It should be pointed out that to calculate peak flow rates in the other locations in Nebraska, one should use the values from NDOR's design manual (NDOR 2006).

2.2.2 BMP Design

The BMPS chosen for testing were bioretention, infiltration trench, filter trench and check dam filters. These were chosen based on roadside criteria such as implementation in the right of way, no permanent pools, low maintenance, cost effective, 80% removal of TSS, heavy metals and total extractable hydrocarbons (Vacha 2012).

Bioretention. Bioretention BMPs can be an aesthetically pleasing and versatile method of treating storm water by means of filtration, bioaccumulation, and settling of pollutants. Bioretention is applicable for roadside use because it can use a) low vegetation and soil berms for minimum hazards for vehicles, and b) short term ponding

for a period of 24 to 48 hours to reduce peak flows. Bioretention can be designed for infiltration or filtration (if under drains are installed), benefiting to the stability of roadway sub grades and shoulders.

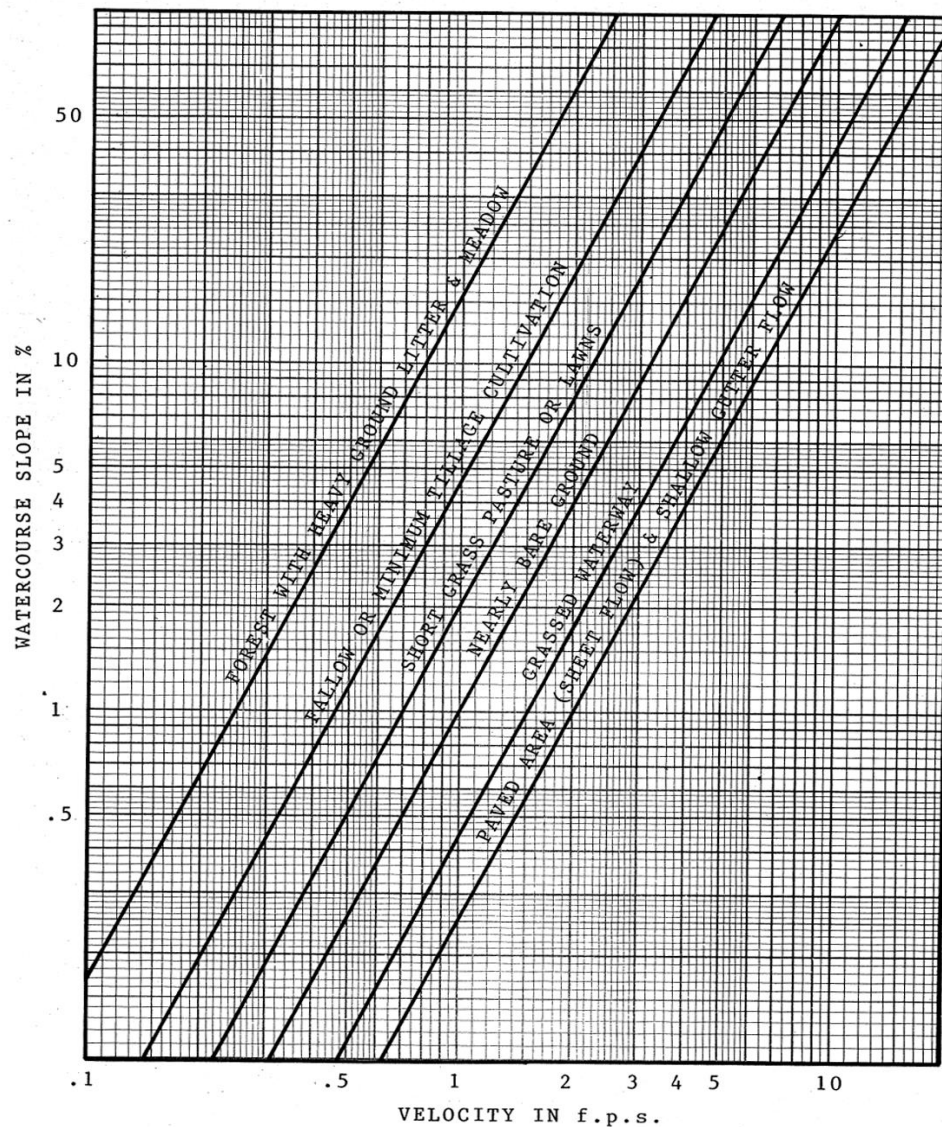

Figure 2.3 Velocities for estimating travel time (Olsson Associates 2006)

Table 2.4 Runoff coefficients for rational method (NDOR 2006)

Character of surface	Return Period (Years)						
	2	5	10	25	50	100	500
Part I: Runoff Coefficients for Developed Areas							
Asphalt	0.73	0.77	0.81	0.86	0.90	0.95	1.00
Grass areas (lawns/parks)	0.75	0.80	0.83	0.88	0.92	0.97	1.00
Poor condition (grass cover less than 50% of the area)							
Flat, 0-2%	0.32	0.34	0.37	0.40	0.44	0.47	0.58
Average, 2-7%	0.37	0.40	0.43	0.46	0.49	0.53	0.61
Steep, over 7%	0.40	0.43	0.45	0.49	0.52	0.55	0.62
Fair condition (grass cover on 50% to 75% of the area)							
Flat, 0-2%	0.25	0.28	0.30	0.34	0.37	0.41	0.53
Average, 2-7%	0.33	0.36	0.38	0.42	0.45	0.49	0.58
Steep, over 7%	0.37	0.40	0.42	0.46	0.49	0.53	0.60
Good condition (grass cover on 50% to 75% of the area)							
Flat, 0-2%	0.21	0.23	0.25	0.29	0.32	0.36	0.49
Average, 2-7%	0.29	0.32	0.35	0.39	0.42	0.46	0.56
Steep, over 7%	0.34	0.37	0.40	0.44	0.47	0.51	0.58
Part II: Runoff Coefficients for Undeveloped Areas							
Cultivated land							
Flat, 0-2%	0.31	0.34	0.36	0.40	0.43	0.47	0.57
Average, 2-7%	0.35	0.38	0.41	0.44	0.48	0.51	0.60
Steep, over 7%	0.39	0.42	0.44	0.48	0.51	0.54	0.61
Pasture/range							
Flat, 0-2%	0.25	0.28	0.30	0.34	0.37	0.41	0.53
Average, 2-7%	0.33	0.36	0.38	0.42	0.45	0.49	0.58
Steep, over 7%	0.37	0.40	0.42	0.46	0.49	0.53	0.60
Forest/woodlands							
Flat, 0-2%	0.22	0.25	0.28	0.31	0.35	0.39	0.48
Average, 2-7%	0.31	0.34	0.36	0.40	0.43	0.47	0.46
Steep, over 7%	0.35	0.39	0.41	0.45	0.48	0.52	0.58

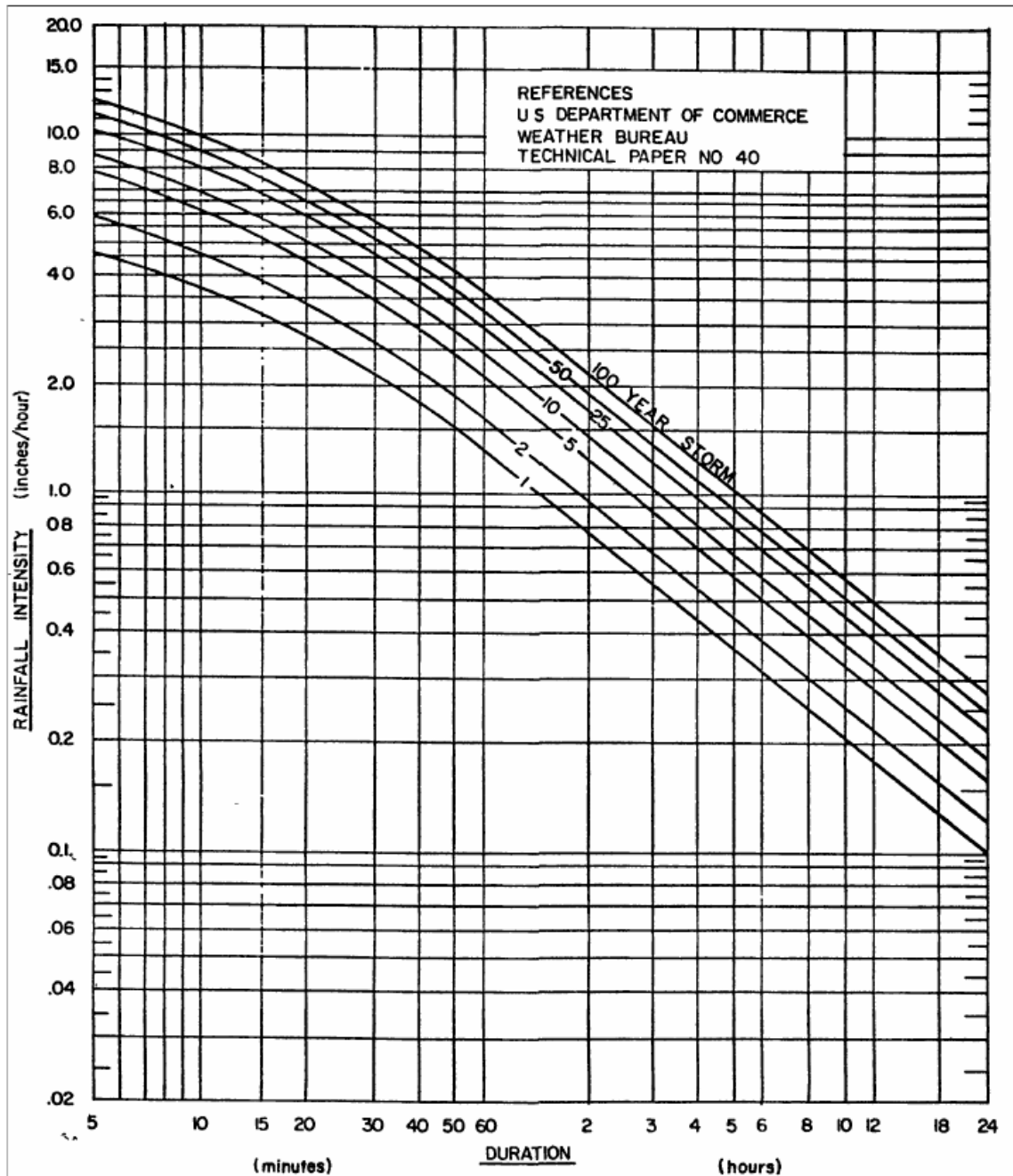

Figure 2.4 Rainfall intensity-duration – Omaha, Nebraska

Table 2.5 Example table of WQV and peak discharges

Drainage area (acres)	0.5 inch WQV (ft³)	10-yr peak discharge (cfs)	Drainage area (acres)	0.5 inch WQV (ft³)	10-yr peak discharge (cfs)
0.1	182	0.86	1.25	2269	10.69
0.2	363	1.71	1.5	2723	12.83
0.3	545	2.57	1.75	3176	14.96
0.4	726	3.42	2	3630	17.10
0.5	908	4.28	2.5	4538	21.38
0.6	1089	5.13	3	5445	25.65
0.7	1271	5.99	3.5	6353	29.93
0.8	1452	6.84	4	7260	34.20
0.9	1634	7.70	4.5	8168	38.48
1	1815	8.55	5	9075	42.75

In the above table, peak discharge is assumed to be from an all concrete watershed using the rational method and a 5 minute time of concentration

Four bioretention cells were designed and installed at the salt valley location. The WQV for the bioretention cells was 6,044 ft³, and the test plots (a total area = 162 ft²) treated 20% of this volume. The peak 10-year flow-rate for the watershed was 26 cfs, which was obtained by the methods explained in section 2.2.1. Equation 2-6 was used to size the surface area of the cells (ISMM 2009).

$$A_f = \frac{WQV \cdot df}{[K \cdot (hf + df) \cdot tf]} \quad (2-6)$$

where:

A_f : Surface area of ponding area (ft²)

WQV: Water quality volume (ft³)

df: Filter bed depth (ft)

K: Hydraulic conductivity of filter media (ft/day)

hf: Average height of water above filter bed (ft)

tf: Design filter bed drain time (days)

For the bioretention cells at the Salt Valley site, the values below were used in equation 2-6: $A_f = 162 \text{ ft}^2$; $WQV = 1215 \text{ ft}^3$; $df = 1.5 \text{ ft}$; $K = 6 \text{ ft/day}$ (for 50% sand and compost mixture) (Hartsig and Szatko 2012); $hf = 0.375 \text{ ft}$; and $tf = 1 \text{ day}$.

The four bioretention cells were 4.5 ft wide and 9 ft long with 18 inches of filter media depth. Inflows to the bioretention cells were diverted from a grassed ditch through a 4 inch PVC pipe and were equally separated to the four cells. Each cell was under-drained with a 4 inch PVC perforated pipe installed in 10 inches of $\frac{1}{4}$ " to $\frac{3}{8}$ " pea gravel. An outflow outlet weir made with a 2 inches by 12 inches board was installed to maintain a maximum ponding depth of 9 inches. Figure 2.5 shows a cross section of the cells, and Figure 2.6 shows a plan view of the bioretention cells.

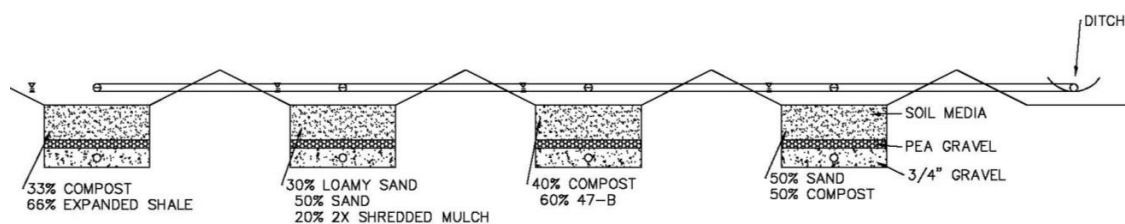

Figure 2.5 Salt valley bioretention cells profile view

Infiltration trench. An infiltration trench can be used as a roadside BMP by placing it within the bottom section of a roadside ditch. Infiltration trenches eliminate the discharge of the WQV effectively, because the entire WQV is captured and not allowed to run off the site (Field et al. 2006).

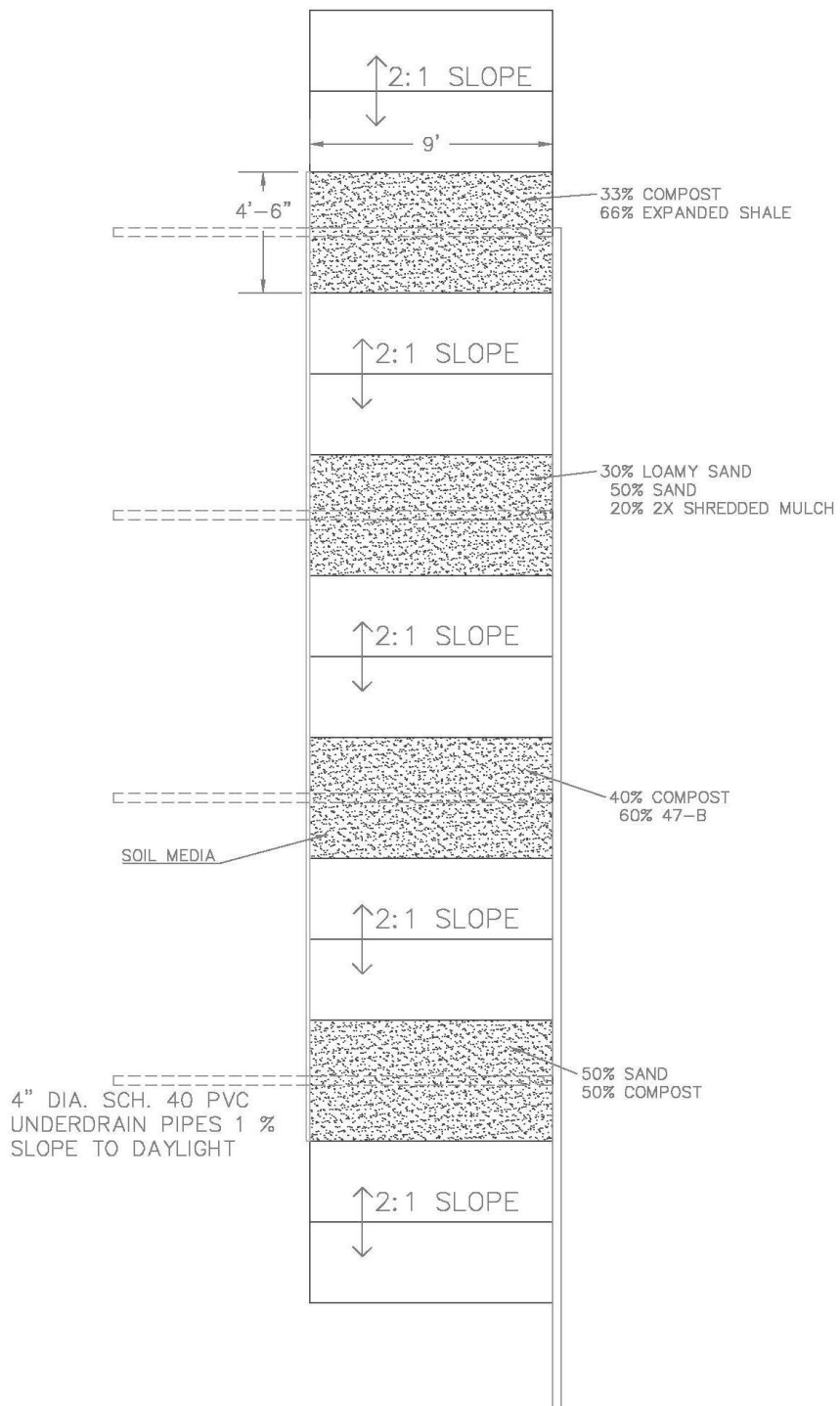

Figure 2.6 Salt valley bioretention cells plan view

The infiltration trench at the Salt Valley site is located in a drainage ditch with a 2.8 percent slope. The trench is 118 ft long, 3 ft wide and 4 ft deep. As shown in Figure 2.7, the trench was filled with 1-3 inch clean stone; the bottom and side walls were wrapped in Mirafi® 170N non-woven polypropylene geotextile filter fabric. The top of the filter fabric enclosure was placed 1ft below the surface to keep any sediment in the upper foot of media. The WQV for the infiltration trench was calculated by multiplying the volume of the trench by the void ratio of the media (typically 0.4). The WQV treated by the infiltration trench was 566 ft³, which was 9 percent of the WQV for the watershed. The peak 10-year flow was 25.9 cfs, obtained by the methods explained in section 2.2.1.

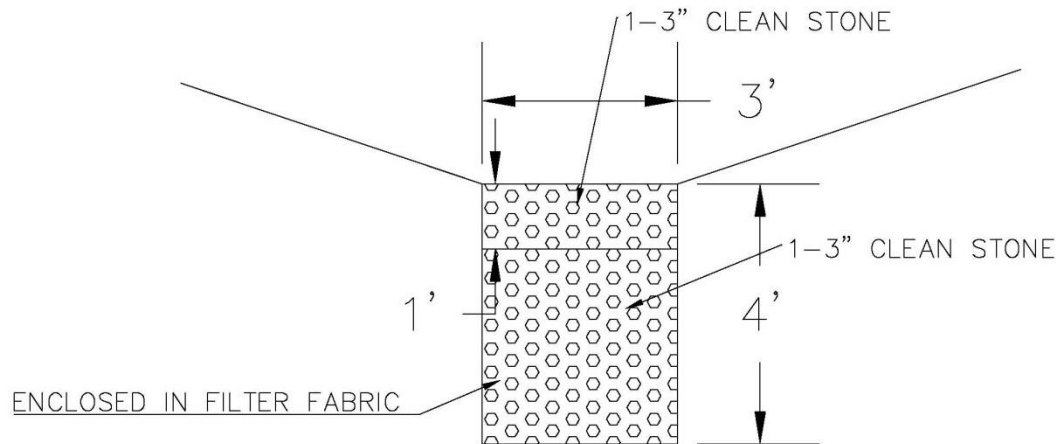

Figure 2.7 Infiltration trench cross section

Filter trench. A filter trench is a trench filled with filter media installed along and parallel to the bottom of a roadside ditch. The storm water is filtered as the slope forces the water to pass through the treatment media. A filter trench is similar to an

infiltration trench but is located on slopes not applicable for infiltration methods.

Filtration is the primary treatment method although some infiltration may be possible where infiltration rates of the native soil are high.

The filter trench at the Salt Valley site is 250 ft long and is located along the bottom of a drainage ditch with a slope of 6.5 percent. The trench is 3 ft wide and 4 ft deep with 6 inches of 3-inch armoring rock on the surface and 7 rip-rap check dams equally spaced along the trench. Two observation wells were installed to check whether the filter was working properly and water was draining. The filter media used was ¼" to 3/8" pea gravel with a porosity of 0.3. The filter trench should be designed so that the WQV is equal to the total void volume of the filter media. The volume treated by the test filter trench was 900 ft³, which is about 25 percent of the WQV of the watershed. The peak 10-year flow for the trench was 21 cfs, which was obtained by the methods explained in section 2.2.1.

Due to the possibly high velocities of water on moderately high roadside ditch slopes, scour protection may be needed for the filter media. The channel velocity of the 10-year peak flow needs to be calculated with equation 2-7 (NRCS 1986):

$$Q = \frac{k}{n} AR^{2/3} S^{1/2} \quad 2-7$$

where:

Q: Flow from 10-year storm (cfs)

S: Slope in direction of flow $\left(\frac{\text{ft}}{\text{ft}}\right)$

R: Hydraulic Radius ($R = \frac{A}{P_w}$)

A: Cross sectional area of flow (ft^2)

P_w : Wetted Perimeter (ft)

n: Manning's coefficient

k: constant (1 for Metric Units; 1.486 for English Units)

The equations for the elements of trapezoidal cross-sections can be found in Table 2.6 with the variables being defined in Fig. 2.8. Manning's coefficient, n for equation 2-7 is calculated for rock lined channels with equation 2-8 (FHWA 2005):

Table 2.6 Geometric elements of trapezoidal cross section

Area of flow (A) (ft^2 or m^2)	$(b+my)y$
Wetted perimeter (P_w) (ft or m)	$b+2y\sqrt{1+m^2}$
Hydraulic radius (R) (ft or m)	$\frac{(b+my)y}{b+2y\sqrt{1+m^2}}$

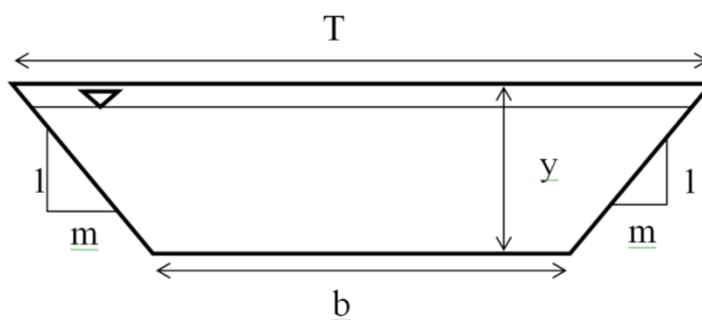

Figure 2.8 Reference shape for Table 2.6

$$n = \frac{\alpha d_a^{1/6}}{2.25 + 5.23 \log_5 \left(\frac{d_a}{d_{50}} \right)}$$

2-8

where:

n: Manning's roughness coefficient, dimensionless

d_a : average flow depth in the channel, (ft)

D_{50} : median riprap/gravel size (ft)

α : unit conversion constant 0.0262 for English units

Equation 2-8 is an iterative equation applicable for the range of conditions where $1.5 \leq d_a/D_{50} \leq 185$. Inserting the geometric elements and Manning's number into the Manning's equation results in Equation 2-9, which is then used to solve for the depth of flow (y) in the ditch over the filter trench by trial and error.

$$Q = \left(\frac{k}{n}\right) * (b+my)y * \left[\frac{(b+my)y}{b+2y\sqrt{1+m^2}}\right]^{2/3} * S^{1/2} \quad 2-9$$

The total iterative process is to find the depth by guessing a Manning's number and then calculating a new Manning's number with the new average depth; three to four iterations should be sufficient for convergence. The final flow depth in the ditch over the filter trench for the designed filter trench was 0.82 ft with a Manning's number of 0.053 and a velocity of 4.69 ft/s by using 1–3" clean rock as a flexible channel lining. Figure 2.9 is a cross section of the filter trench.

If rock lining is not sufficient to mitigate flow velocities, rip-rap check dams may need to be installed also. The check dams designed for the test filter trench were 1.5 ft in height with 2:1 slopes. The D_{50} of the rock media was 9 inches, and seven check dams were spaced equally along the trench about 35 ft apart. Due to cost and availability at the

site for rip-rap, broken concrete and used concrete core samples were placed instead of rip-rap. Table 2.7 shows some typical values found in the literature for spacing of rip-rap check dams placed in channels for velocity and erosion control. Figure 2.10 shows a typical cross section.

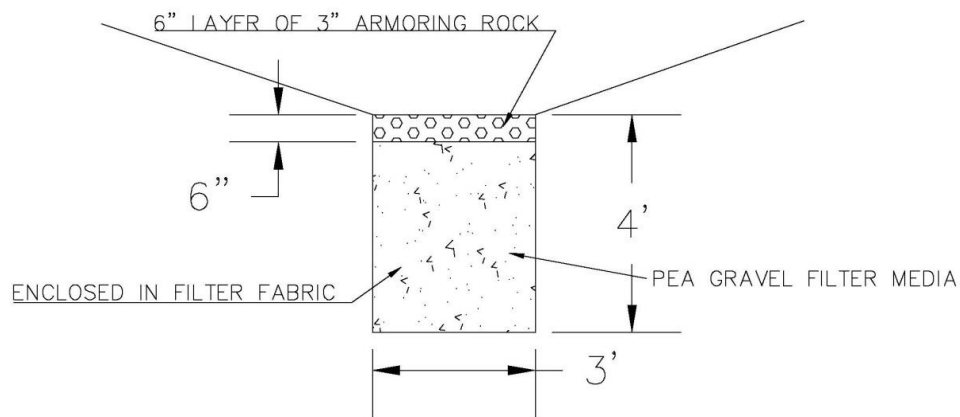

Figure 2.9 Cross section of filter trench

Table 2.7 Typical spacing of riprap check dams placed for velocity and erosion control (MPCA 2000)

Ditch grade (%)	Spacing (feet)
1	200
2	100
4	50
6	33
Above 6% ditch grade, you may need to flatten the slope	
8	25
10	20

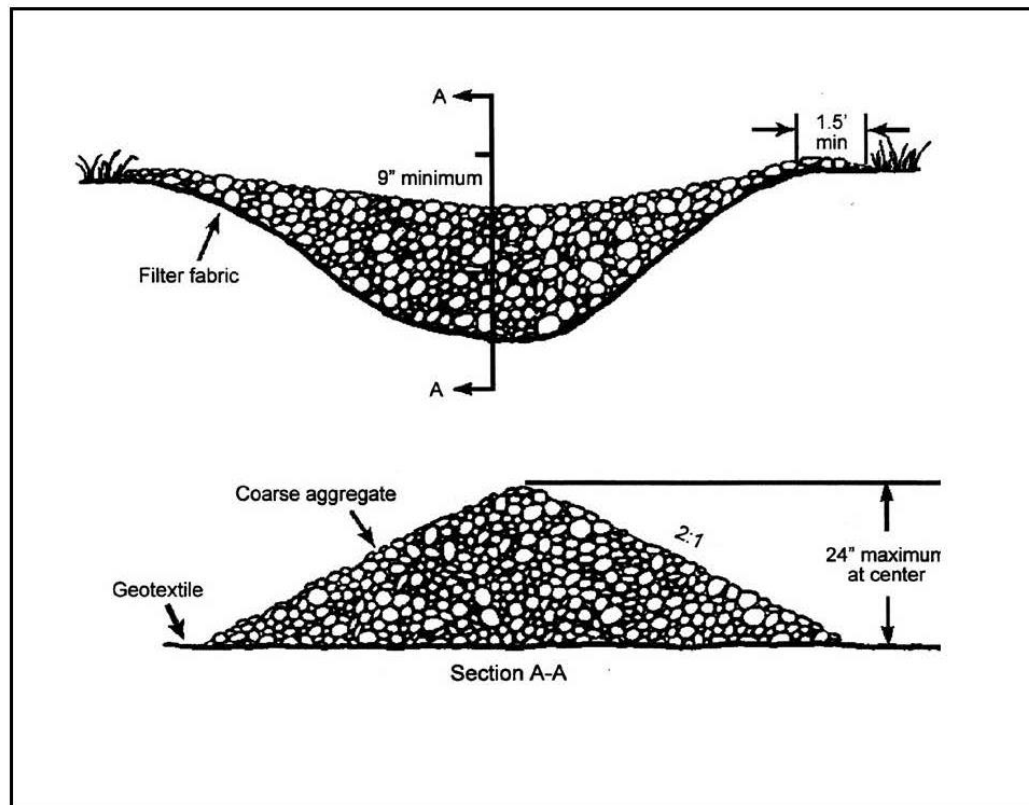

Figure 2.10 Typical riprap check dams cross and longitudinal sections (MPCA 2000)

Check dam filters. Check dam filters are a modification or hybrid design of filter trenches and check dams. Water is temporary impounded behind an earthen check dam within the roadside ditch and then is filtered down and underneath the dam through a pea gravel-filled trench to outlet on the downhill side of the dam. Check dam filters are optimal in ditches where check dams are already being considered for erosion control reasons. Four check dams installed in series at the I-Street site are located on a 6.5 percent slope. The WQV of the watershed was 988 ft³ and the peak 10-year flow was 10.15 cfs, which was obtained by the methods explained in section 2.2.1. The check

dams are able to treat more than the WQV based on the design sizing.

Equation 2-10 was used to calculate the WQV that could be captured using the check dams (PSBMP 2006) and Figure 2.11 explains the variables used in equation 2-10.

$$V = 0.5 * L * D_s * (W + W_b)/2 \quad 2-10$$

Where:

V: Volume behind the check dam (ft³)

L: Length of Swale Impoundment Area (ft)

D_s: Depth of Check Dam (ft)

W: Top Width of Check Dam (ft)

W_b: Bottom Width of Check Dam (ft)

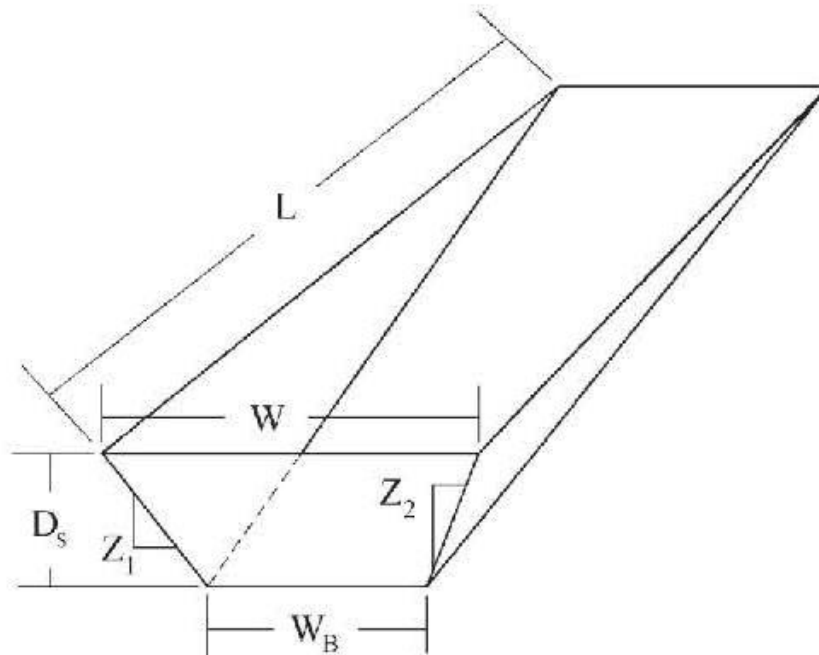

Figure 2.11 Variables used to calculate check dam volume (PSBMP 2006)

Figures 2.12, 2.13, and 2.14 are the profile view, side view, and plan view of the check dam filters designed in this study. To check the drawdown time for the media chosen in the design, Darcy's law (equation 2-11) was used (Gupta 2008). The flow-rate should be greater than or equal to the volume of water that can be impounded behind the check dam.

$$Q = AK \frac{\Delta h}{l} \quad 2-11$$

Where:

Q: flow-rate (ft³/day)

A: Cross-sectional area of media (ft²)

K: Hydraulic conductivity of the media (ft/day)

Δh : Change in elevation (ft)

L: Length of media (ft)

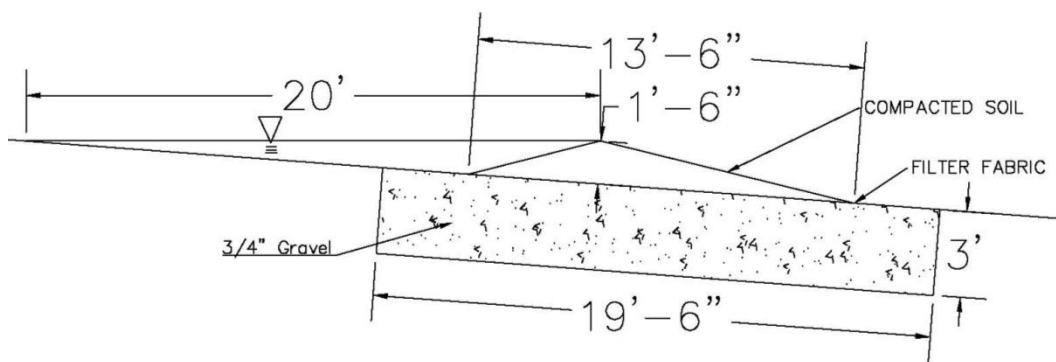

Figure 2.12 Check dam filter profile

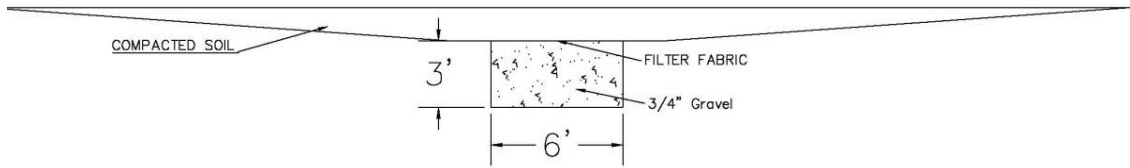

Figure 2.13 Check dam filter cross section

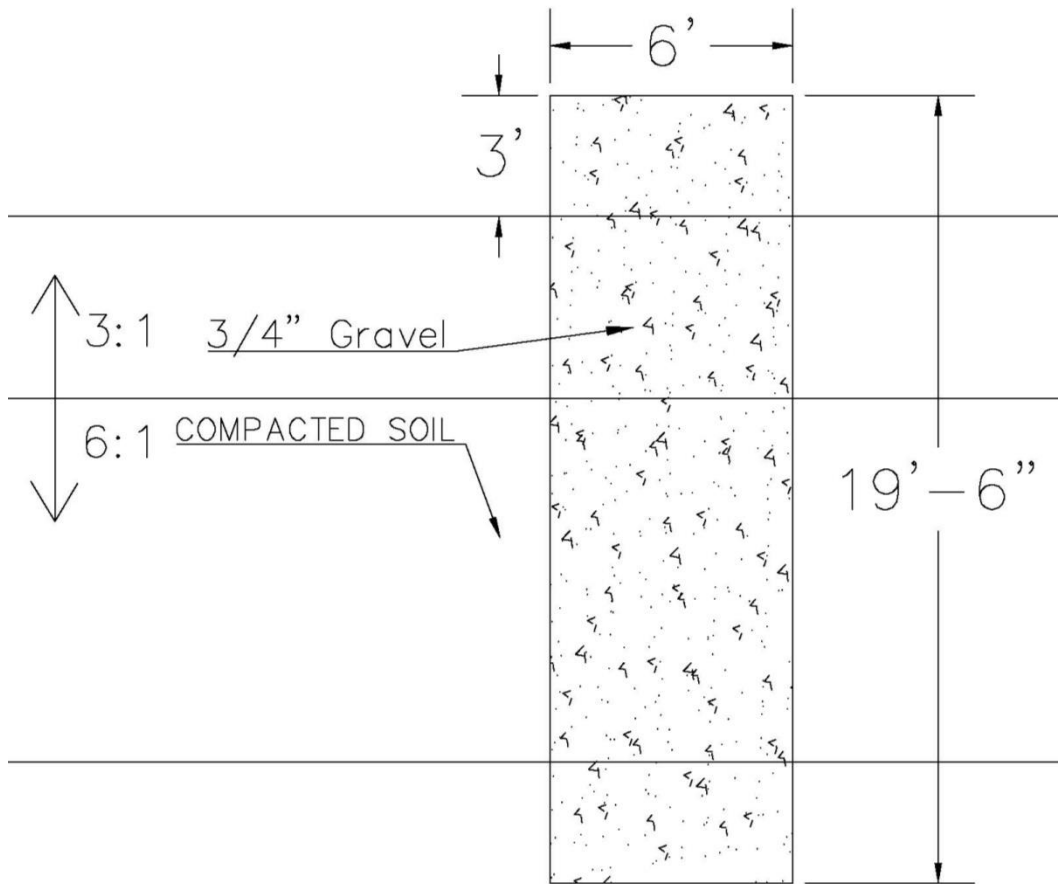

Figure 2.14 Check dam filter plan

2.2.3 BMP Materials and Soil Media

The materials and media used in BMPs have great impacts on the final treatment efficiency of pollutants. For BMPs that rely on filtration such as bioretention cells, check dam filters, and filter trenches, the choice in media type and size ultimately decides the treatment efficiency for certain target pollutants. For infiltration type BMPs, the media size and type determine how much of the WQV can be stored in the media's pore space. In this project, similar media were chosen when applicable for both the project sites except for the bioretention cells where four types of medium mixtures were used.

The soil texture classification at the I-street test site was Silt Loam (NRCS 2011) which was used in lab testing in chapter 3. Silt Loam has a content range of clay (0–25%), sand (0–50%), and silt (50–80%). A soil sample from the I street site was sent to Midwest Laboratories for a texture analysis, the results were a content of 24% clay, 20% sand and 56% silt.

At the Salt Valley location the most predominant soils were Silty Clay and Silty Clay Loam (NRCS 2011). Silty Clay and Silty Clay Loam have a relatively wide content range of clay (25–60%), sand (0–20%), and silt (40–70%). Because soil texture classifications have content ranges, any calculations used in the design mixtures were assumed to have sand, silt and clay content equal to the area centroid of the NRCS-USDA soil texture classification triangle shown in Figure 2.15. The minimum infiltration rates for silt loam, silty clay, and silty clay loam are 0.15–0.30, 0–0.05, and 0–0.05 in/hr, respectively (Gupta 2008). Due to these moderate to low infiltration rates, if any native

Bioretention cell media. Bioretention media must serve three primary purposes:

i) have sufficient infiltration rates for acceptable drawdown times; ii) filter sediments and pollutants; and iii) support plant growth. Bioretention cells rely on physical, chemical, and biological processes, including sedimentation, filtration, and sorption on mulch and soil layers, plant uptake, and biodegradation by soil microorganisms to remove pollutants (Davis et al. 2001). Based on literature reviews and objectives of this project, four soil mixtures were used as the media of the bioretention cells: 1) 50% grout sand (Table 2.8) and 50% compost (Table 2.9); 2) 40% NDOR 47-B gravel (Table 2.10) and 60% compost; 3) 30% loam, 50% grout sand and 20% wood mulch; and (4) 33% compost and 66% expanded shale.

Sand and 47-B gravel used for bioretention cells should meet ASTM C33 standards for gradation (Low Impact Development Center, Inc. 2003; WRA Environmental Consultants 2009). Tables 2.8 and 2.10 compare the Mallard Sand and Gravel used in the field testing to NDOR aggregate classes and a designed sand mixture for Contra Costa County, California. The use of easily available media and specification can aid in roadside BMP construction.

In this study, the compost called LinGro used in the bioretention cells came from the city of Lincoln, NE composting service. LinGro was chosen because of its price and availability. Compost was added to the bioretention media to help support plant growth with nutrients and root support, and to promote infiltration of storm water as well. Table 2.9 compares the spring 2012 Midwest Laboratories LinGro compost test report values with other compost standard design values.

Table 2.8 Sieve design specification for ASTM C33 grout sand

Size / Sieve #	Percent passing (by weight) min-max		
	Bioretention sand ^a	Class D aggregate ^b	Grout Sand ^c
1 ½"	–	–	–
3/8"	100–100	–	–
0.187"/No. 4	90–100	100–100	100–100
0.093"/No. 8	70–100	–	95–100
0.0787"/No. 10	–	90–100	–
0.0464"/No. 16	40–95	–	70–100
0.0238"/No. 30	15–70	39–75	40–75
0.0164"/No. 40	5–55	–	–
0.0118"/No. 50	–	–	10–35
0.0059"/No. 100	0–15	–	2–15
0.0029"/No. 200	0–5	0–6	0–5

^a(MSG 2011); ^b(NDOR 1997); and ^c(MSG 2011).

Table 2.9 Physical and chemical properties of compost used in engineered soil mixtures

Property	LinGro ^a	WEAEC ^b	WDNR standard ^c
Particle size < 19 mm (0.75")	100%	95%	> 98%
Organic matter	27.76%	35% –75%	≥ 40%
Ash	24.6%	NA	≤ 60%
C:N	10.6:1	< 25:1	10–20:1
pH	8.1	6.5–8	6–8
Conductivity	5.75 mS/cm	NA	≤ 10 mhos x 10 ⁻⁵ cm ⁻¹
Moisture content	44.67%	30% –55%	35% –50%

^aLinGro is a compost available locally in Lincoln, NE. ^bWRA Environmental Consultants (2009); ^cThompson et al. (2008).

Table 2.10 Sieve design specification for ASTM C33 47-B gravel

Size and Sieve #	Percent passing (by weight) min-max		
	Bioretention sand ^a	Class B aggregate ^b	47-B ^c
1 ½"	–	–	100–100
1"	–	100–100	–
¾"	100–100	–	–
0.187"/No. 4	90–100	77–97	77–97
0.093"/No. 8	70–100	–	–
0.0787"/No. 10	–	50–70	50–70
0.0464"/No. 16	40–95	–	–
0.0238"/No. 30	15–70	16–40	16–40
0.0164"/No. 40	5–55	–	–
0.0118"/No. 50	0–15	–	–
0.0059"/No. 100	0–5	0–3	0–3

^a(MSG 2011); ^b(NDOR 1997); and ^c(MSG 2011).

Expanded Shale was tested as a light-weight supplemental material to reduce the need for materials with a higher cost and bulk density, i.e., sand and gravel. Higher bulk density material has a small unit volume, and thus, can be more costly (due to both material and transportation costs). In this study, rubber chips were initially to be tested in the bioretention cells. However, due to unexpected circumstances, expanded shale was considered and chosen. Expanded shale is produced by heating raw shale to 2,000 °C, which expands the clay into larger porous particles, generally 0.5 inch diameter (TNLA

2006). Expanded shale in bioretention soil mixtures was expected to improve drainage and hold water for extended periods making it available for plants in drier periods. Expanded shale was found to be chemically durable in municipal solid waste leachate. Therefore, storm water constituents should not be detrimental to expanded shale's integrity (Bowders et al. 1997).

Aggregates used in BMPs. The aggregates used in the test BMPs were 1–3" clean limestone aggregate and 1/4–3/8" clean pea gravel (see Table 2.11 for details). All aggregate used was considered "clean" by industry terms from a conversation with an aggregate supplier *Martin and Marietta*, which means less than 5% fines passing the #200 sieve. Aggregate was clean because of the quarry or sand pits mining processes. In the design of the BMPs, all aggregate void ratios were assumed to be 0.4. The rip-rap check dams were designed for rip-rap sized to a D₅₀ of 9" but broken concrete and used core samples were used due to price and availability.

Table 2.11 Aggregates used in test BMPs

BMP type	1–3" clean limestone	1/4–3/8" clean pea gravel
Check dam filters	Not used	Filter media
Bioretention cells	Not used	Under drain media
Filter trench	Armoring	Filter media
Infiltration trench	Total aggregate used	Not used

2.2.4 Monitoring Methods Used

Methods for monitoring the field-scale BMPs mainly included:

- Drawdown rates (i.e., the speed at which an amount of storm water can infiltrate) of water in the infiltration trench, bioretention cells, and check dam filters need to be checked. Drawdown rates affect plants because they can become over saturated if rates are too slow or not have enough water during dry periods if rates are too fast. Efficiency of pollutant removals based on filtration rates is also affected by drawdown rates. Also, drawdown rates affect extended period ponding which should be less than 24 or 48 hours. Due to very little rainfall, infiltration rate measurements were not able to be taken.
- Clogging was monitored on all BMPs to determine the life expectancy of the BMP after which the BMP does not work with the design efficiency. Most clogging of BMPs occurred during construction or immediately following completion due to lack of construction erosion control. Therefore, no baseline was measured, and clogging monitoring was hampered.
- Vegetation establishment was monitored on the bioretention cells to compare which soil medium supported vegetation the best. Vegetation planted was NDOR shoulder seed mixture (see Table 2.12) for the NDOR planting region B (see Figure 2.16). For monitoring vegetation establishment in the four bioretention cells, digital photos were taken about every 2 weeks with a 6.2 Megapixel Nikon Coolpix L1 camera. To take the picture, a house hold, 2-step, step ladder was used to stand on for taking a picture of each test cell from the south end of the cell looking north; this was done arbitrarily for convenience. Images were taken in the midday hours for better lighting except for the last test visit which was done in the dawn hours and proved to be detrimental to

the results. A control check image was taken and tested from a residential lawn in good condition in Papillion, NE (appendix B). After digital images were taken they were cropped, loaded onto a personal computer, and analyzed with Image J software. To analyze the images the thresholds of hue, saturation, and brightness were adjusted to 47-107, 0-255, and 0-255, respectively. The hue was set to 47-107 to narrow the green spectrum (Patton et al. 2005). The pixels measured with this threshold are considered green, and when divided by the total pixels in the image, results in the percent of green cover in the image (see appendix B for examples).

Table 2.12 Seed mixture for Nebraska region B (NDOR 2010)

Rural Highway Shoulder Mixture		
Species	Minimum Purity (percent)	Lbs. of PLS/acre
Perennial ryegrass – Linn	85	7
Slender wheatgrass	85	4
Western wheatgrass – Flintlock, Barton	85	6
Kentucky fescue	85	1.5
Blue grama – NE, KS, CO	30	2
Buffalograss – Cody, Bison, Sharp’s Improved, Texoka	80	4
Sideoats grama – Trailway, Butte	75	3
Sand dropseed (<i>Sporobolus cryptandrus</i>)	90	0.2
Oats/Wheat (wheat in the fall)	90	14

Minimal monitoring of the field-scale BMPs was accomplished during 2012 because, after BMP construction was completed in June, rainfall amounts were extremely low as indicated in Table 2.13. General BMP conditions were monitored through site visits and photos after each rain event.

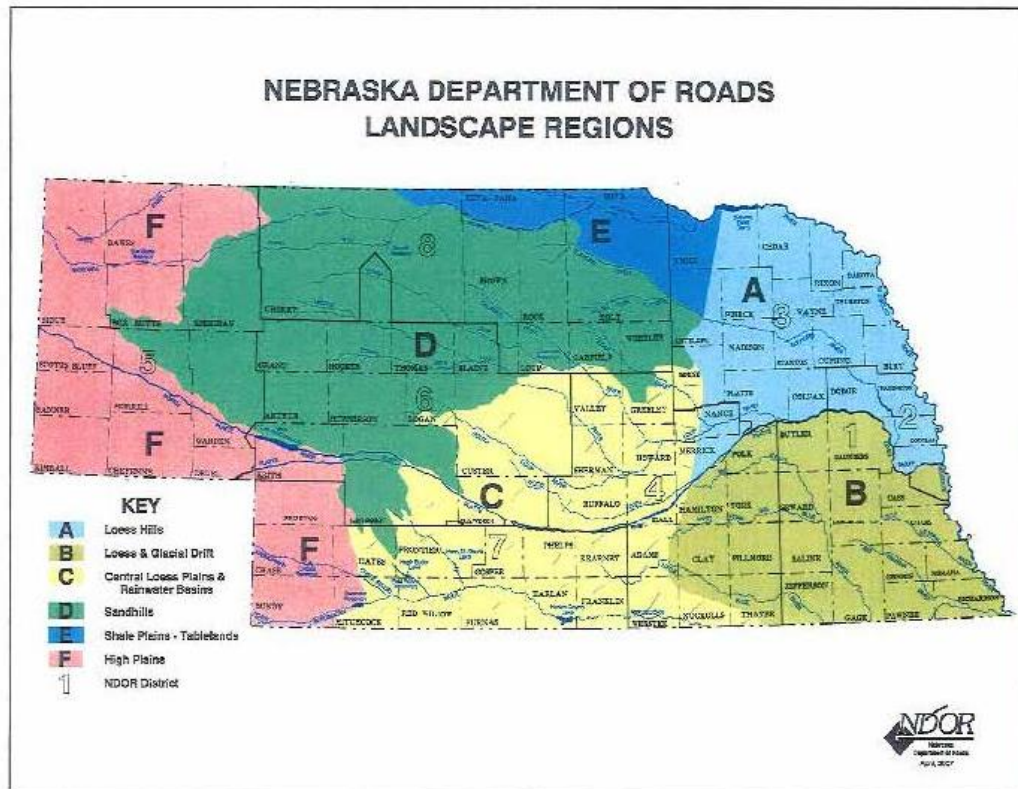

Figure 2.16 Nebraska seed mixture planting regions (NDOR 2012)

Table 2.13 Rainfall amounts in 2012 for both project sites (NCDC 2012)

Month	Normal precipitation Lincoln, NE (in)	Actual precipitation Lincoln, NE (in)	Departure from normal precipitation Lincoln, NE (in)	Normal precipitation Omaha, NE (in)	Actual precipitation Omaha, NE (in)	Departure from normal precipitation Omaha, NE (in)
January	0.67	0.16	-0.51	—	—	—
February	0.66	2.69	+2.03	—	—	—
March	2.21	1.14	-1.07	2.13	0.86	-1.27
April	2.9	3.67	+0.77	2.94	4.26	+1.32
May	4.23	2.98	-1.25	4.44	1.94	-2.5
June	3.51	5.03	+1.52	3.95	3.98	+0.03
July	3.54	0.12	-3.42	3.86	0.07	-3.79
August	3.35	0.69	-2.66	3.21	1.35	-1.86
September	2.92	1.87	-1.05	3.17	1.68	-1.49
Year to Date	23.99	18.35	-5.64	23.7	14.14	-9.56

2.3 Results and Discussions

Field monitoring assessed a) sediment buildup and construction period problems, b) vegetative establishment and c) the establishment of a monitoring scheme. Within the monitoring scheme only vegetative monitoring was able to be performed due to very little rainfall during the monitoring period. Detailed results and discuss are presented below.

Sediment buildup and construction period problems. Sediment buildup was experienced in all BMP types except the bioretention cells. Some of the initial buildup was from rain events that occurred during the construction period. The construction period was between the end of December 2011 and the end of June 2012 (Table 2.14). Most post construction sediment accumulation was a result of lack of erosion control measures such as erosion control blankets, silt fencing, and temporary vegetation.

Table 2.14 Estimated BMP construction time period

BMP	Start	Finish
Bioretention	April 30, 2012	June 25, 2012
Check Dam Filters	February 25, 2012	May 5, 2012
Infiltration Trench	December 27, 2011	January 6, 2012
Filter Trench	January 6, 2012	March 1, 2012

The bioretention cells did not experience this initial sediment buildup because they were built as an off-line type BMP and were constructed in midsummer when few rain events happened during construction. The rain event that did occur during the construction of the bioretention cells did not affect the cells because the diversion

structure was not in place and stormwater was not diverted into the BMP (appendix B). Post construction sediment loading was minimal for the bioretention cells because there was little rainfall and because the whole watershed remained stabilized during construction.

The check dam filters were inundated with about 2 inches of sediment after the first rain event after installation (indicated by circle 1 in Figure 2.17 and circle 2 in Figure 2.18). The source of the sediment was the disturbed soil from the installation of the check dams themselves (indicated by circle 2 in Figure 2.17), which can be prevented by installing erosion control blanket or other soil stabilization procedures.

Upon inspection of the amount of clogging, it was found that most of the sediment was able to be removed by shovel. After removing of sediment, the gravel used as check dam filter media was exposed (indicated by circle 1 in Figure 2.18). These results indicate that a) we need to study the methods for preventing sediment transport after BMP construction, b) how to quantify the sediment transport and their effects on BMPs, and c) how to remove sediment once they clog the BMPs. Future projects can use photos or measurements to monitor the amount of sediment accumulation. A baseline measurement before any rain events is crucial in monitoring procedures. Depth of sediment can be measured and general area can be measured semi-quantitatively by photos.



Figure 2.17 Check dam filter clogging

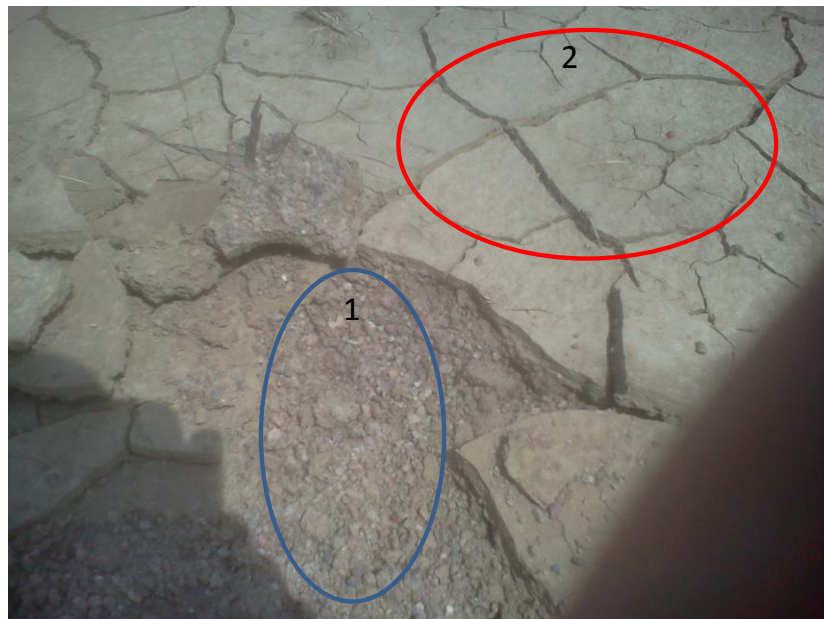

Figure 2.18 Check dam filter gravel and clogging

The infiltration trench experienced very little sediment buildup. Initial buildup was from a small area of disturbed soil near the trench as indicated by circle 1 in Figure 2.19. The contributing watershed for the infiltration trench remained stable during and after construction otherwise. Some further buildup continued to occur from the area entering the trench at circles 2 indicated in Figure 2.19. The sedimentation experienced on the infiltration trench did not prove detrimental to its operation because the general size of the sediment deposited on the trench was about a 5' by 3' area out of the total 118' by 3' area of the trench shown by circle 3 in Figure 2.19.

The sediment buildup experienced by the infiltration trench can be prevented by stabilizing this area with erosion control blanketing and establishing permanent vegetation. Temporary erosion control can be done by placing silt fencing along the trench. Monitoring of the clogging of infiltration trenches can be done semi-quantitatively by photos or by measuring the depth and areas of sediment deposits. One method attempted was to bury an aggregate filled bucket in the top section of trench in hopes of catching sediment then removing the bucket and analyzing the amount of sediment captured (see Appendix B for photo). It was unsuccessful because of little rain events in this study.

The filter trench experienced high amounts of clogging from the ditch side slopes (Figure 2.20). The side slopes were 3:1 and were not covered with erosion control blanketing and were not stabilized during construction. During construction, rain events occurred with enough precipitation to cause rilling on the side slopes (Figure 2.20). This side slope erosion could have been prevented with erosion control blanketing or silt

fencing installed along the bottom of the slope. Because no baseline measurement was taken, accurate monitoring of these rills was not accomplished. In the future, monitoring of rills can be done by counting the number of rills and measuring their size and length to get a volume of soil eroded, which can also be linked with rain events if such measurements are done before and after the rain events.



Figure 2.19 Infiltration trench clogging

The check dams installed on the filter trench caught some of this sediment, and so did the armoring (Figure 2.21). To prevent the buildup of sediment on the BMP, material erosion control must be done as soon as possible on any disturbed soil area within the watershed of the BMP. Just like in the monitoring of the rill erosion sediment, deposition can be monitored with measuring the depth and area of the deposits. This was impracticable for this study because a majority of the trench was clogged. Monitoring of

the deposits can also be done semi-quantitatively with photo logging to acquire a general surface area of the deposit.



Figure 2.20 Filter trench side slope rills

By the end of the observation period, weeds (cycle 2) and plants (cycle 1) were growing in the accumulated sediment (Figure 2.22). The amount of sediment buildup was enough to sustain root establishment in the trench. The clogging and plant growth can prevent water from being able to enter the trench. The best effort to prevent vegetative growth on the rock covering of the trench is to prevent organic matter or sediment buildup. It may be more feasible to build a BMP designed with a fast infiltrating top layer that support plant growth which would improve infiltration rates and stabilize the plant roots would BMP.



Figure 2.21 Filter trench sediment buildup on armorings and check dams



Figure 2.22 Filter trench sediment buildup and vegetative growth



Figure 2.23 Filter trench undermining at beginning of trench

Flows in the ditch were high because evidence shows that some of the check dam material (used concrete core samples) was being washed or moved down slope (shown in the red circle in Figure 2.24). This is a good example that concrete debris (i.e. used core samples and broken concrete) is not as useful as rip rap because the shape of the concrete debris is not irregular or interlocking like rock brought in from a quarry. The force of water can move this concrete debris more easily.

Some problems arose related to the structural integrating of the filter trenches setup. Undermining occurred at the beginning of the trench, creating a hole as shown in Figure 2.23. This problem was mitigated by adding more rock material up to the top of the ditch as shown in the blue circle where the hole was located at the bottom of the blue

circle Figure 2.24. The knowledge gained from this situation is that the armoring needs to extend above the beginning of the trench or the trench needs to start at the pipe outlet to the ditch. Undermining also occurred at a couple spots along the trench as shown in Figure 2.25. This is thought to be from higher than expected flow velocities within the pea gravel filter media eroding the sides of the underground trench. This could be fixed by filling the hole with 1-3 inch rock or in the design of the trench by using smaller treatment media to slow the filter flow rate.



Figure 2.24 Filter trench added 1-3 inch rock at beginning and check dam material migration (water flow direction: from the top to bottom of the picture)

Corrections to the situations encountered with sediment problems could be to maintain a tight BMP construction schedule to have constructed BMPs stabilized or built between rain events. Also, post construction and during construction erosion control

measures are crucial to the initial and long term efficiency of the BMP. Some of these erosion control measures are erosion control blanketing, crimped straw, temporary or permanent vegetation, silt fencing, and straw bales.



Figure 2.25 Filter trench undermining hole along trench

Vegetative monitoring. Traditional monitoring is done by taking cuttings from a test area, and then drying and weighing the vegetative growth. Also color is traditionally monitored by visual inspection on a rating scale of 1–9 (Karcher and Richardson 2003). For this research, image analysis was done using Image J software. Table 2.15 and Figure 2.26 shows the results of the vegetative monitoring.

The compost 47-B test cell had the slowest growth but the highest green growth of the four cells (Fig. 2.26). These mixtures benefits may be from the wide size range and

well graded 47-B that aids in conductivity of the mixture. Also the compost could be well distributed throughout the mixture with the 47-B.

Table 2.15 Percent of image that is green from Image J analysis

Test plot	Date							
	7/11	7/25	8/9	8/22	9/7	9/13	9/26	10/10
Compost/sand = 50/50	7.29	20.98	44.20	31.60	53.43	57.53	63.15	21.55
Compost/47-B = 40/60	1.73	6.22	11.82	16.30	48.88	67.33	63.85	32.21
loam/sand/wood mulch = 30/50/20	2.02	12.11	39.23	17.70	39.53	46.48	49.88	20.06
compost/expanded shale 33/66	1.42	3.17	5.88	8.91	41.32	54.52	48.16	31.17

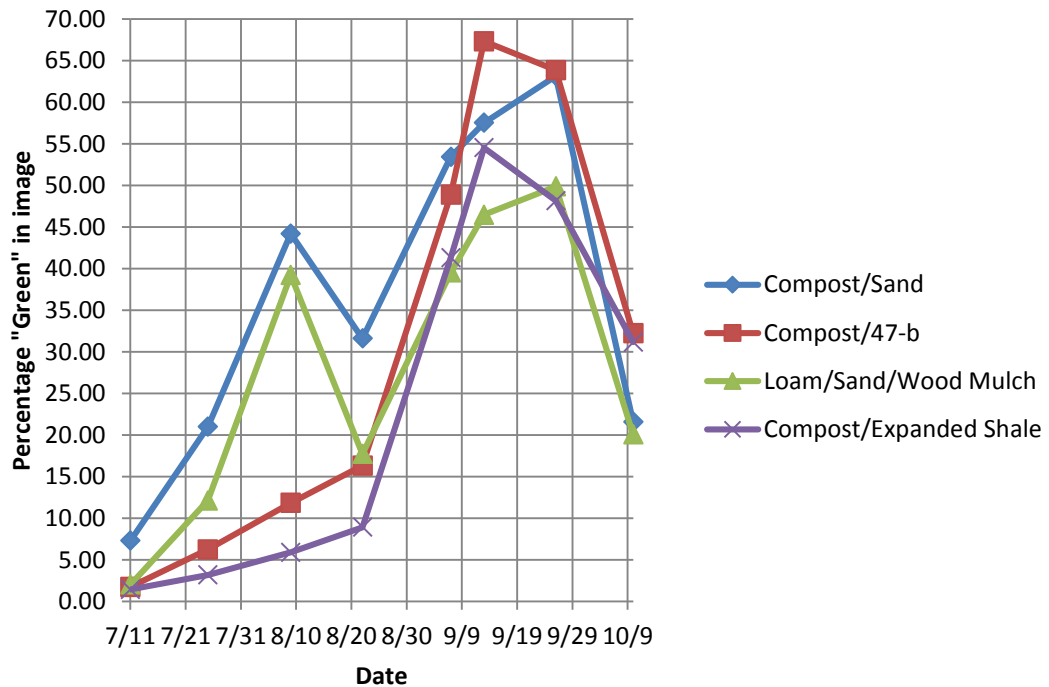

Figure 2.26 Percent of image that is green from Image J analysis

The compost/sand had the best initial growth and the second best peak growth percentage. The sand/compost mixture provided good drainage and good pore spaces for root growth and, with the addition of compost for nutrients, showed the second best results from testing (Fig. 2.26).

The test cell filled with loam/sand/wood mulch had moderate initial growth and the lowest total green growth. The moderate initial growth of this mixture could be from the mixture being comprised of similar local soils and supplemented with sand and mulch for drainage and nutrients. Over time this mixture may have had more settling than the other mixtures, resulting in some limitation for plant root growth.

The compost/expanded shale cell had the worst initial growth and the third best final growth percentage. This may be caused from the large amount of pore spaces provided by the expanded shale or the temperature of the media because the compost and rock could hold the heat. The heating effect of the media could have been more detrimental because of the lack of rainfall during the month of July.

All of these mixtures may have too high infiltration rates to support excellent plant growth. This is only speculation because no substantial rain events occurred during testing. Soil temperature has an influence on plant growth, and any kind of mulch on the soil's surface influences soil temperatures as shown by the solid and dotted line in Figure 2.27 (Willis and Power 2012). Mulch can keep the soil cooler in the morning hours and hold the heat from the day longer into the evening, helping plant growth as well as contributing moisture holding capacity and nutrients. Soil temperatures at or above 110°F to 125°F can kill weed seeds and plant seeds (Stapleton 2008). Mulch and other heat

holding materials can also hurt root growth by raising soil temperatures too high from absorbing the sun's heat.

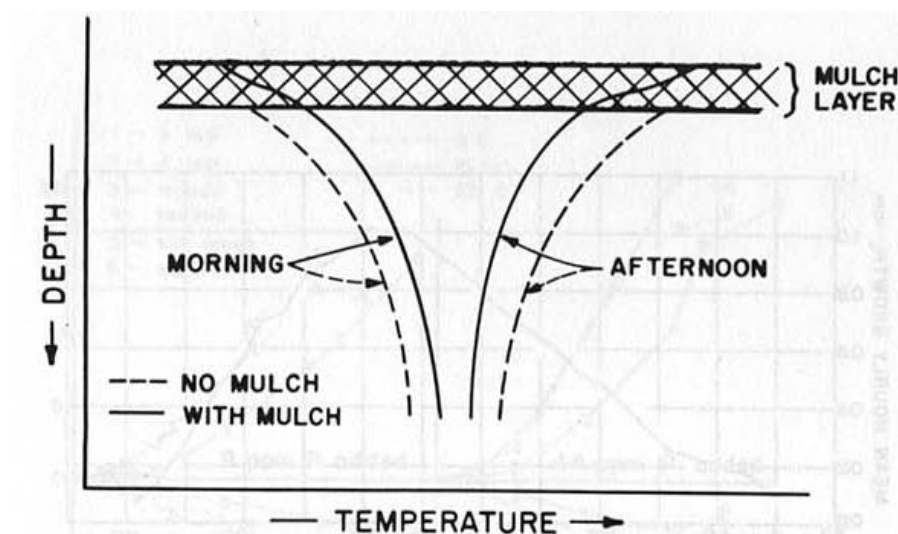

Figure 2.27 Expected soil temperature profiles with and without mulch (Willis and Power 2012)

The dip (after 8/20) on Figure 2.26 is due to the cutting of weeds by the NDOR maintenance group between measurement dates, which lowered the green in the image although only weeds were removed. Some example images of percent plant growth from testing and the control check image can be found in Appendix B (Figs. B.14–B18). The effect of removing the weeds on the amount of green vegetation in the images is one of the drawbacks to using image analysis for plant growth. The use of this image analysis is indiscriminant on whether it is grass, weed, or a piece of green litter. One problem that occurred in image analysis is that some creeping ground cover grew on the edges of the compost expanded shale cells contributing to the green amount although the plant roots

were not necessarily in the test cell but the plant cover was. Another aspect of this image analysis to comment on is that the green in the image was specified by a hue of 47–100 (Patton et al. 2005). This hue can be adjusted slightly to adjust what the user considers green. The benefit of a hue range is that dead plant growth or deleterious brown material is not counted and only good quality growth is. What outweighs the drawbacks of image analysis is that it is unbiased measurement compared to some traditional methods and a large area can be tested at once instead of random test plotting. The extreme slump in the last week (10/9) is explained by shadows because the images were taken in the dawn hours, indicating that light conditions may affect image analysis from shadows (Karcher and Richardson 2003).

Discussion. The major recommendations that can be made from the site observations are a) erosion control measures are imperative during and after construction, b) BMPs should be build off-line whenever possible, c) stabilization of the area around the BMP and the contributing watershed with vegetation should be accomplished as soon as possible, d) specific to the filter trench armoring should extend upstream from the start of the trench about 5–10 ft and up the side slopes about 1–2 ft.

The bioretention cells experienced little problems with sedimentation but had problems with vegetative establishment because of little rainfall. Therefore, it is important to find better soil types and vegetation to guarantee plant establishment without human help.

The check dam filters experienced high amounts of clogging from the disturbed soil due to the construction process. This should be mitigated with erosion control BMPs

during and after construction until the area is stabilized with vegetation. To prevent longer term clogging the use of a high infiltration top layer medium that supports plant growth could be implemented.

The infiltration trench had some erosion problems that should be mitigated with erosion control measures and stabilization also. Long term clogging may be prevented by placing high infiltration top layer media that supports plant growth too.

The filter trench had problems with clogging and structural integrity. Clogging can be prevented with erosion control and stabilization as for all BMPs. The structural integrity issues with undermining and holes at the top and side of the trench can be mitigated on site by placing 1–3 inch rock. Also, they could be prevented by some design changes. To prevent undermining, armoring should be extended upstream from the start of the trench about 5–10 ft and up the side slopes about 1–2 ft. Furthermore, to prevent side trench undermining, smaller filter media could be used to slow the flow rate within the media; this could also increase treatment efficiencies.

Table 2.16 Four BMPs tested advantages and disadvantages

BMP	Advantages	Disadvantages
Check dam filters	Installed in ditch	Pea gravel easily clogged
Bioretention	Can be built off-line	1) complex construction 2) need elevation change for outlets
Infiltration trench	1) Installed in ditch 2) Easy to install	Can clog because of large pore spaces
Filter trench	Uses slope for treatment	Scour protection needed for high slopes

Table 2.17 General recommendations of the four BMPs.

BMP	Recommendation
Check dam filters	Place fast infiltrating plant growth media cover over gravel
Bioretention	Develop low maintenance plant growth media
Infiltration Trench	Place fast infiltrating plant growth media cover over rock
Filter Trench	1) Improve check dams with better rip-rap 2) Use smaller treatment media size

General monitoring scheme. Although vegetative monitoring was the only data results found during the monitoring of the BMPs, general monitoring methods were established for all BMPs tested. The primary things that could be monitored are vegetative growth, rill or erosion measurement, sedimentation, filter fabric clogging, infiltration rates, and site visit picture documentation. Traditional methods of vegetative monitoring rely on measuring the biomass of a randomly selected area to be tested or measuring the total biomass of the plant material by removing it from the test site. In this project, digital images were taken, and the percent area of plant matter was found using image J analysis.

Rill and erosion measurement can be performed after each rainfall event. This is done by counting and measuring the number and depth of the rills that are at least 0.5 inches deep in the area of interest. The volume of sedimentation can be estimated by measuring the depth and area of each particular deposit within the BMP. For BMPs where filter fabric is used, such as the infiltration and filter trenches, sections of filter fabric can be removed and replaced to monitor clogging of the fabric by fine particles. To do this, the section removed, can be weighed before and after to calculate the mass of

sediments collected. Infiltration rates for the infiltration trench and bioretention cells can be monitored by site inspection within 12 or 24 hours after a rain event to record the draw-down time and depth of the water collected. General documentation by digital photos can describe the state of the BMPs such as weeds, plants, sediment deposits, and rill areas. Table 2.18 summarizes criteria and methods for these general observations and monitoring procedures.

Table 2.18 Site visit criteria and methods

Criteria	Method Description
Vegetation (%)	<ul style="list-style-type: none"> • A baseline digital photo is taken and at regular periods during the plant growth time being monitored. • Digital photos are analyzed with Image J software to find the percent green in each image.
Drawdown rate (in/hr)	<ul style="list-style-type: none"> • After a rain event and a known period of time later (i.e. 12 h) the depth of water in the observation pipes are recorded. • The change in depth divided by the change in time is the drawdown rate.
Volume of rills (ft ³)	<ul style="list-style-type: none"> • After each rain event rills can be counted and the width and depth recorded. • Multiplying the width, depth and number of rills can give an estimate of the volume of sediment eroded.
Volume of sediment deposits (ft ³)	<ul style="list-style-type: none"> • By estimating a surface area and depth of sedimentation patches, a volume of deposition can be estimated. • This can also be done semi-quantitatively by taking photos from the same position over time to monitor the general deposit size.
Mass of sediment on filter fabric (g/m ³)	<ul style="list-style-type: none"> • Where filter fabric is placed near the top of trenches a known section can be massed before use as a baseline. • After some deposition happens on the filter fabric it can be removed and massed. • The change in mass can be estimated to be the amount of particles that contributed to clogging.

2.4 Conclusions

Several conclusions can be drawn from the field monitoring of the four BMPs to treat highway runoff.

- Sedimentation within BMPs is a crucial factor that cannot be over-looked during and after the construction period. Construction periods should be kept as short as possible to minimize the chance of rain events during construction. During and after the construction phase, erosion control measures should be placed and maintained as soon as possible until the contributing area is stabilized with vegetation.
- From Image J analysis, the compost/47-B test cell had the best vegetative performance. In contrast the loam/sand/wood mulch test cell had the worst vegetative growth of the four cells. All cells had between 48 and 64 percent green in the best images.
- Although only vegetative monitoring was accomplished, a monitoring matrix is important for reporting the long term use and efficiency of these BMPs. Monitoring methods should focus primarily on clogging and treatment of solids.

Chapter 3 Lab Testing of Rubber Chip Mediated Soil Mixtures

3.1 Introduction

Bioretention cell was first developed in Prince George County, Maryland in the 1980's (Ming-Han et al. 2010). Bioretention BMPs and other filtration BMPs rely on engineered soil media to treat storm water via physical, chemical, and biological processes. The engineered soils (infiltration media) are commonly composed of sand, soil, and compost, and are typically covered with a mulch layer and planted in diverse vegetation (Thompson et al. 2008). Research on the engineered soil media to be placed in bioretention cells, and other BMPs has been in continuous development since the establishment of such BMPs.

Research most commonly recommends bioretention media to be a soil with a NRCS textural classification of sandy loam or loamy sand (PGCM 2007). An alternative medium that could be tested is rubber chips. Studies have shown that rubber crumb can be used as an effective filter medium achieving similar results when used as a pollution control medium on green roofs and within other storm water controls (Wanielista et al. 2008). Testing done in Florida showed that the expected concentration of rubber crumb used in the up-flow filter for discharges from a wet detention pond is much lower than the Lethal Concentration for 50% kill (LC50) or the acute toxicity (Wanielista et al. 2008). However, information is not available on using rubber chips as engineered media in bioretention cells or other BMPs.

The objective of this chapter is to evaluate the feasibility of using rubber chips as a supplement to BMP media. Testing of the chemical and physical properties of rubber chips added to traditional BMP media, such as silty loam soil, sand, and compost, was done to evaluate the practicality and safety of using rubber chips. The primary focus of our tests was to check whether adding rubber chips would decrease bulk density, increase infiltration rates and provide a light-weight filler material to BMPs; in addition, chemical analysis of influent and effluent concentrations of bioretention cells were performed to check pollutant concentrations that may leach from the mixtures of the media tested.

3.2 Materials and Methods

Materials. Silty loam soil was obtained from the project site located at the Interstate 80 and I street on-ramp in Omaha, NE. The rubber chips were supplied by Bruckman Rubber Co., Hastings, NE, USA. The rubber chips were 3–4 Tyler mesh (0.365"–0.187") size with a porosity of 0.53. The sand used was purchased at a local home and garden store and was Quickrete® all purpose sand that meets ASTM C33 standards for gradation. The compost was purchased at a local nursery and is Oma-Gro brand produced by the City of Omaha, which is similar to the Lin-Gro brand used in the Lincoln project site BMPs. This compost is made exclusively of grass clippings, leaves, and ground wood produced from yard waste collected and composted by the city of Omaha for Oma-Gro.

Column reactors. The reactor columns were made with 3-inch diameter PVC pipe. The total height of the columns was 29 inches, 9 inches for ponding depth, 18 inches of media, and 2 inches of free drain space at the bottom. Sampling ports, effluent ports, and an overflow were located along the side of the column (Figure 3.1).

Media. To test the chemical and physical properties influenced by rubber chips, eight column reactors were built and filled with 4 media mixtures in duplicate, i.e., 1) 50% silty loam soil and 50 % rubber chips (SLR), 2) 50% sand and 50% rubber chips (SR), 3) 50% compost and 50% rubber chips (CR), and 4) 100% rubber chips (R).

Synthetic storm water. The synthetic storm water was used as the feed solution of the columns (Table 3.1). Roadway sediment, kaolin, sodium carbonate, and sodium chloride were added to simulate the typical solids distribution of highway storm water runoff. Roadway sediment also adds any leachable storm water constituents that are present in roadway runoff. Metal nitrates were added for the source of metals (lead, copper, and zinc) and nitrate. All concentrations used are comparable to those found in highway runoff (Kebelin et al. 1998).

Table 3.1 Synthetic storm water constituents and concentrations (Kebelin et al. 1998)

Constituent	Concentration (mg/L)	Constituent	Concentration (mg/L)
Roadway sediment ^a	500	Zn(NO ₃) ₂ •6H ₂ O	0.91
Kaolin	40	Na ₂ CO ₃	0.9
Pb(NO ₃) ₂	0.16	NaCl	200
Cu(NO ₃) ₂ •H ₂ O	0.11		

^aThe portion used was passed through the 250 micrometer (mesh # 60) sieve of the sediment collected from a local highway storm water outfall (e.g., the I-80 detention basin near 108th Street in Omaha). The sediment was collected on 4/26/2012 and contained high amounts of sandy material most likely due to winter runoff from the roads.

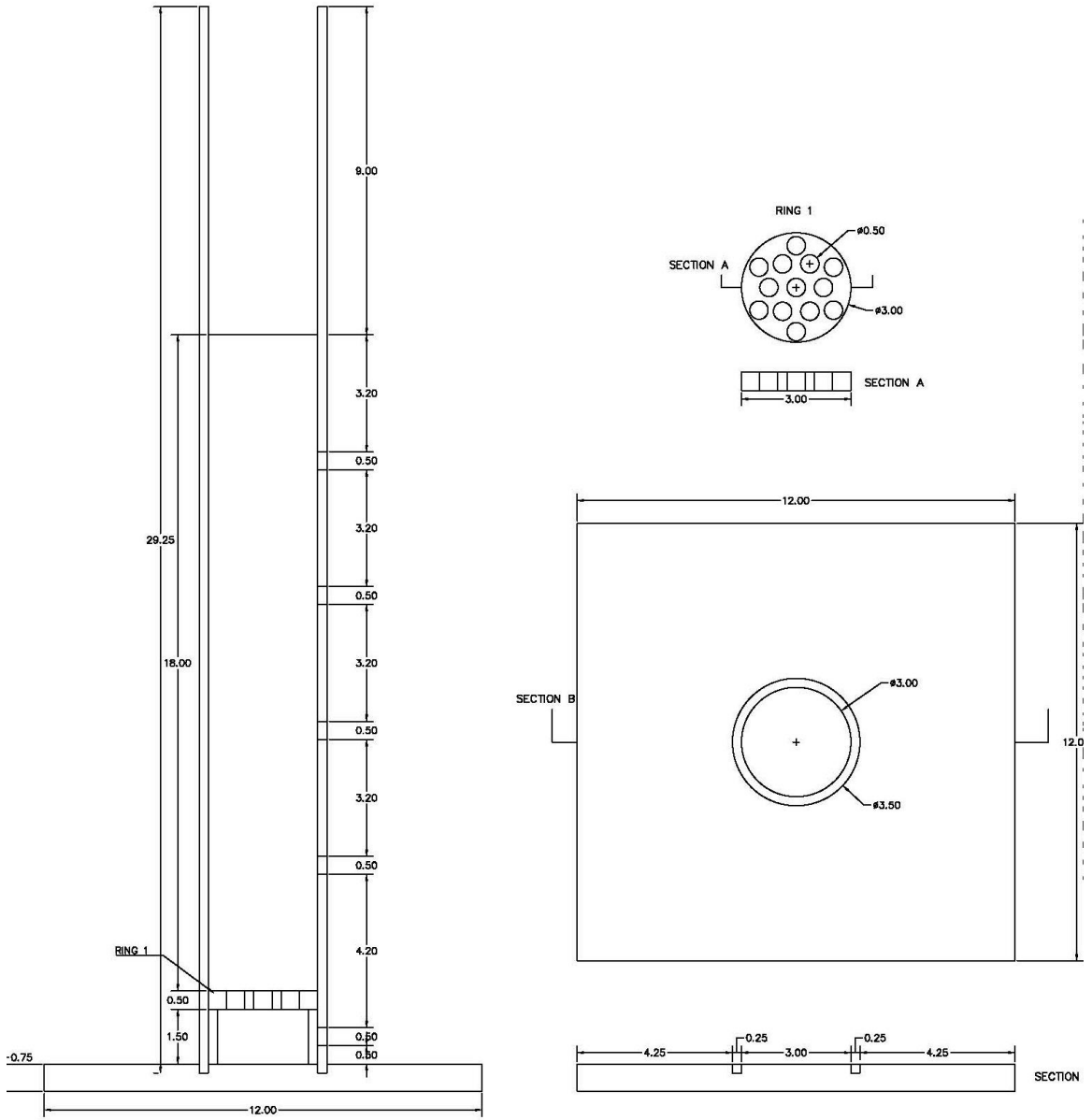

Figure 3.1 Reactor plans

Physical properties tested. The following physical properties of the medium mixtures were tested: a) the initial settling, b) initial and final saturated hydraulic conductivity, c) bulk density, d) field capacity, e) wilting point, and f) available moisture.

For a), after the columns were loaded with 18 inches of media, 5 liters of tap water were ran through the reactors, 1 liter per run. After each run the change in the medium depth was recorded and settling stabilized after 5 liters.

For b), initial and final saturated hydraulic conductivity was measured based on the ASTM D2434 standard and a flow-through testing method used in *Physical and Hydraulic Properties of Engineered Soil Media for Bioretention Basins* (Thompson et al. 2008). The saturated hydraulic conductivity procedure consisted of a consistent inflow and outflow rate with 9 inches of head above the soil media being held constant. Tap water was run through a hose to the top of the reactor and ponding (9 inches water height) was allowed up to an overflow port. Once steady flow from the effluent port and overflow port were observed for a 15 to 30 minute period, effluent volumes were measured with a graduated cylinder for a given time period (i.e., 900 mL for 30 seconds). Three readings were taken to check consistency.

Saturated hydraulic conductivity was calculated using equation 3-1.

$$K_{\text{sat}} = \frac{Q \cdot L}{A \cdot t \cdot h} \quad 3-1$$

where:

K_{sat} : Saturated hydraulic conductivity (cm/s)

Q: Volume of water passed through column (cm³)

L: Length of soil media (cm) = 45.72 cm

A: Cross sectional area of column (cm^2) = 45.6 cm^2

t: Time for Q to pass through the column (s)

h: Height of water column plus soil media (cm) = 68.58 cm

After 10 consecutive weeks of loading the reactors, final saturated hydraulic conductivities were checked using the same method as the initial hydraulic conductivity test. Then the top 2.5 inches of media were removed and replaced with new media, and the saturated hydraulic conductivities were checked again with the same method to inspect the influence of clogging in the top 2.5 inches of media.

For c to f, bulk density, field capacity, wilting point, and available moisture were tested by Midwest Laboratories (Omaha, NE). Field capacity was measured at 1/3 BAR (= 100 kPa) only, wilting point was measured at 15 BAR and available moisture was measured with 1/3 BAR and 15 BAR limits with a membrane apparatus.

Procedure for leaching tests. After initial settling and hydraulic conductivity were recorded, treatment efficiencies and constituent concentrations were tested. One liter of synthetic storm water (Table 3.1) was loaded every 7 days to each of the 8 columns for a 10 week period (so total 10 liters were loaded). Loading was done every 7 days to represent a drying time between loadings based on a period greater than Antecedent Moisture Condition (AMC) type II which is 5 days (Gupta 2008). The one liter volume of loading was based on the volume required to fill the ponding depth of 9 inches (corresponding to the design ponding depth of the field-scale bioretention cells) in the 3 inch diameter column. One representative influent sample was taken at the halfway point of column loading (after loading 5 liters of the 10 total liters). The effluents from

each column were collected with a separate sampling bottle, which then was used to represent a composite effluent sample of that column.

Analytical methods and data analysis. Table 3.2 shows the analytical methods used and the constituents that were analyzed.

Table 3.2 Constituents, methods, and method detection limits

Constituent	Method (APHA et al. 2012)	Method Detection Limit ($\mu\text{g/L}$)
Iron	Sec. 3125 B	5.198
Nickel	Sec. 3125 B	3.373
Copper	Sec. 3125 B	2.100
Zinc	Sec. 3125 B	2.201
Lead	Sec. 3125 B	3.794
Chromium	Sec. 3125 B	12.362
Silver	Sec. 3125 B	7.436
Cadmium	Sec. 3125 B	1.228
Antimony	Sec. 3125 B	8.404
Nitrate as Nitrate	Sec. 4110 A	276
Total Suspended Solids (TSS)	Sec. 2540 D	10,000
COD	Sec. 5220 D	5,000

Metals analysis. This test follows part 3000 and section 3125 B of Standard Methods (APHA et al. 2012). Samples were preserved with 2% (v/v) trace metal grade

nitric acid (Fisher A509-212) after collection. Samples were analyzed with a 2004 Varian Inductively coupled plasma mass spectrometry (ICP-MS). Samples were preserved with nitric acid but not digested or filtered. Total metals are considered the concentration of metals determined from an unfiltered vigorously digested sample. Dissolved metals are considered metals from an unacidified sample filtered through a 0.45 μm filter (APHA et al. 2012). Our samples were preserved and unfiltered because of the analysis and preservation method and are most closely related to the definition of total metals.

Nitrate analysis. This test follows section 4110 B of Standard Methods (APHA et al. 2012). Nitrate was analyzed using 792 Basic IC Metrohm ion chromatograph instrument with an anion IC column (P/N: ANX-99-8511) and a flow rate set to 1.35 mL/min. Before measuring, samples were filtered through a 0.45 μm syringe filter. A solution of 1.8 mM sodium carbonate and 1.7 nM sodium bicarbonate was used as the eluent. The concentration of nitrate in the samples was determined against standards.

TSS analysis. This test follows Section 2540 D of Standard Methods (APHA et al. 2012). A continuously stirred sample was filtered through a weighed standard glass-fiber 0.45 μm filter and the residue retained on the filter was dried to a constant weight at 103–105 $^{\circ}\text{C}$ for 1 h. The increase in weight of the filter represents the TSS.

Chemical oxygen demand (COD) analysis. COD was tested for the last 3 weeks of reactor loadings. Samples were preserved with 2% (v/v) sulfuric acid (Fisher A300-212) and analyzed per APHA 5220 D methods colorimetric method (APHA et al. 2012). The digestion vials used were 0-15,000 ppm range CAT. 2415915. The spectrophotometer used was a Genesys 10 uv from thermo scientific set to a 600 nm.

Treatment efficiencies of each column were calculated using equation 3-2 and plotted for comparison. Also the influent and effluent concentrations were recorded and compared to Nebraska Department of Environmental Quality (NDEQ) stream standards (NDEQ 2006).

$$\text{Efficiency} = \left(\frac{C_{in} - C_{out}}{C_{in}} \right) * 100 \quad 3-2$$

Leachable nitrates and metals from the roadway sediment were checked as the controls by mixing 0.1 g of sediment in 50 ml de-ionized water and 10 ml of trace metal grade nitric acid for 3 hours and then measuring metals and nitrates in the solution. The tap water used in making the synthetic storm water was also checked for metals and nitrates. In this case, tap water was taken from the same sink used and persevered by the same methods of all other samples of that type. The sediment and tap water metal control checks were refrigerated and did not require addition of acid because of the leaching process. Both tap water control checks did not require any acid addition and were refrigerated until analysis.

3.3 Results and Discussions

3.3.1 Initial Settling

The initial settling of the reactor media is an important aspect in order to know the volume of material that would be needed in the field to build BMPs without needing additional material later after settling occurs. The results in Table 3.3 show that the rubber chips have no settling after flowing 5 liters of water through the columns. In

contrast, the compost rubber mixture had the greatest settling of 2.78 percent. The compost most likely had the greatest settling due to its low bulk density.

Table 3.3 Initial settling of reactor media

Reactor ^a	initial depth from top of reactor (in)	final depth from top of reactor (in)	Change (in)	Change (%)
R1	8.875	8.875	0	0
R2	8.75	8.75	0	0
CR1	8	8.5	0.5	2.63
CR2	9	9.5	0.5	2.78
SR1	9	9.25	0.25	1.39
SR2	7.75	8.25	0.5	2.60
SLR1	8.875	8.875	0	0
SLR2	8.5	8.75	0.25	1.35

^aR = rubber, CR = compost/rubber, SR = sand/rubber, SLR = silty loam/rubber

3.3.2 Saturated Hydraulic Conductivities

Table 3.4 shows typical hydraulic conductivities of different filter media. The saturated hydraulic conductivity results from initial, final, and after replacing the top 2.5 inches of media are found in Tables 3.5, 3.6, and 3.8, respectively. In all saturated hydraulic conductivity testing, the reactors with only rubber chips (R) had the highest conductivity values followed by the compost rubber chip mixture (CR). The lowest conductivity values were found in the sand rubber mixture reactors (SR). In comparing the results found in testing with Table 3.4, all the media types except rubber chips (R) have a saturated hydraulic conductivity comparable to medium gravel, and the rubber chips (R) are comparable to coarse gravel. The change in conductivity after loading the

reactors weekly for 10 weeks with synthetic storm water is found in Table 3.7. All columns had a decrease in conductivity except the compost rubber (CR) columns. Lower conductivity was caused most likely from continued settling of media and clogging of some pore spaces. However, in the CR columns, fine particles (presumably from the media due to the brown color on filters from TSS testing) were observed in the effluent, and this leaching of fine particles increased pore sizes in the columns, resulting in higher conductivity after 10 week loading of synthetic storm water.

Table 3.4 Typical hydraulic conductivities (Gupta 2008)

Formation	Hydraulic conductivity (cm/s)
Gravel, Coarse	1.16–9.95
Gravel, Medium	0.023–1.16
Gravel, Fine	0.023–0.058
Sand, Coarse	0.00012–0.58
Sand, Medium	0.00012–0.058
Sand, Fine	0.000011–0.023
Silt, Sandy	0.0012–0.0046
Silt, Clayey	0.00023–0.0012
Till, Gravel	0.035
Till, Sandy	0.00023
Till, Clayey	0.00000012
Clay	0.00000058

It is recommended that the top 2–5 cm of the BMP's filter surface be scraped off every two years to prevent hydraulic failure (Hatt et al. 2008). Therefore, after the final test for conductivity, an additional test for conductivity was conducted to check the effect of surface clogging on the saturated hydraulic conductivity. The top 2.5 inches of the media was removed and then replaced with the same type but new media. Results

indicate that after replacing the top 2.5 inches, the saturated hydraulic conductivity decreased in all reactors except for SLR2 as shown in Tables 3.8 and 3.9. The compost rubber reactors had the largest decrease between 0.5 to 1 cm/s, and the other reactors decreased between 0.077 to 0.005 cm/s. The decrease may be from the introduction of new fine material component of the media being reintroduced after being flushed out during the 10 weeks of testing. Also the decrease may be from settling of the media from the 10 weeks of testing flows.

Table 3.5 Initial saturated hydraulic conductivity

Reactor ^a	volume of water flowed through (ml)	time of flow through (s)	K cm/s	K in/hr
R1	960	5	2.807	3978
R2	810	4.2	2.820	3996
CR1	391	30	0.191	270
CR2	162	30	0.079	112
SR1	122	30	0.059	84
SR2	200	30	0.097	138
SLR1	476	30	0.232	329
SLR2	250	30	0.122	173

^aR = rubber, CR = compost/rubber, SR = sand/rubber, SLR = silty loam/rubber

3.3.3 Other Four Important Physical Characteristics of Media

Bulk density, field capacity, wilting point, and available moisture are all physical characteristics of the media that can affect plant growth. As shown in Table 3.10, for the materials tested in this study, the highest bulk density was found to be the expanded shale

and sand mixture (ESS), and the lowest was found to be the rubber chips (R). Compost Rubber (CR) had the best moisture properties. The soil mixture with the worst ability to hold moisture available for plants was the rubber (R) only.

Table 3.6 Final saturated hydraulic conductivity

Reactor ^a	volume of water flowed through (ml)	time of flow through (s)	K cm/s	K in/hr
R1	757	5.2	2.128	3017
R2	737	5	2.155	3054
CR1	950	12	1.157	1640
CR2	947	21.2	0.653	926
SR1	90	30	0.044	62
SR2	125	30	0.061	86
SLR1	508	30	0.248	351
SLR2	90	30	0.044	62

^aR = rubber, CR = compost/rubber, SR = sand/rubber, SLR = silty loam/rubber

Table 3.7 Difference in initial and final saturated hydraulic conductivity

Reactor ^a	ΔK cm/s	ΔK in/hr
R1	-0.679	-962
R2	-0.665	-942
CR1	0.967	1370
CR2	0.574	814
SR1	-0.016	-22
SR2	-0.037	-52
SLR1	0.016	22
SLR2	-0.078	-111

^aR = rubber, CR = compost/rubber, SR = sand/rubber, SLR = silty loam/rubber

Table 3.8 Saturated hydraulic conductivity after replacement of top 2.5" of media

Reactor ^b	volume of water flowed through (ml)	time of flow through (s)	K cm/s	K in/hr
R1	N/A ^a	N/A	N/A	N/A
R2	N/A	N/A	N/A	N/A
CR1	200	30	0.097	138
CR2	175	30	0.085	121
SR1	80	30	0.039	55
SR2	85	30	0.041	59
SLR1	350	30	0.171	242
SLR2	170	30	0.083	117

^a N/A = not tested because apparatus wasn't working for these reactors

^bR = rubber, CR = compost/rubber, SR = sand/rubber, SLR = silty loam/rubber

Table 3.9 Difference in saturated hydraulic conductivity before and after replacing the top 2.5 inches of media

Reactor ^b	ΔK cm/s	ΔK in/hr
R1	N/A	N/A
R2	N/A	N/A
CR1	-1.06	-1502
CR2	-0.568	-805
SR1	-0.005	-7
SR2	-0.019	-28
SLR1	-0.077	-109
SLR2	0.039	55

^a N/A = not tested because apparatus wasn't working for these reactors

^bR = rubber, CR = compost/rubber, SR = sand/rubber, SLR = silty loam/rubber

Bulk density can affect plant growth. Figure 3.2 shows the growth limiting bulk densities for soil types based on the NRCS soil texture triangle. The growth limiting bulk

density is the relative point of density where root growth starts to become inhibited by the density of the soil the roots are located in. The growth limiting bulk density is related to the average pore size radius of each soil class (Daddow and Warrington 1983). Figure 3.2 is used to find the growth limiting bulk density by first locating the soils percent sand, silt, and clay on the figure and finding or interpolating its growth limiting bulk density value. For example, the silty loam used in testing was 20 percent sand, 56 percent silt and 24 percent clay. The textural point is located on the 1.45 g/cm³ isodensity line. So the growth limiting bulk density of this soil is 1.45 g/cm³. The mixture of silty loam mixed with rubber chips (SLR) had a measured bulk density of 1.5 g/cm³ (Table 3.10). The addition of the rubber chips did not improve the bulk density of silty loam above the growth limiting bulk density based on the value of 1.45 g/cm³ shown in Figure 3.2.

Table 3.10 Physical characteristics of media tested

Sample ^c	Bulk density (g/cm ³)	Field capacity 1/3 BAR %	Wilting point 15 BAR %	Available moisture %
SLR	1.5	19.77	13.32	6.45
SR	1.75	1.97	0.98	0.99
CR	1.18	44.44	38.26	6.18
R	0.04	6.84	6.44	0.4
ESS ^a	2	9.09	7.95	1.14
ESC ^b	1.3	29.92	28.47	1.45

^cR = rubber, CR = compost/rubber, SR = sand/rubber, SLR = silty loam/rubber

^a ESS = expanded shale sand; ^b ESC = expanded shale compost. Note: these two media were not loaded into the column for different tests, but were used in the field-scale BMPs, and thus, were tested here to compare a natural porous product to rubber chips.

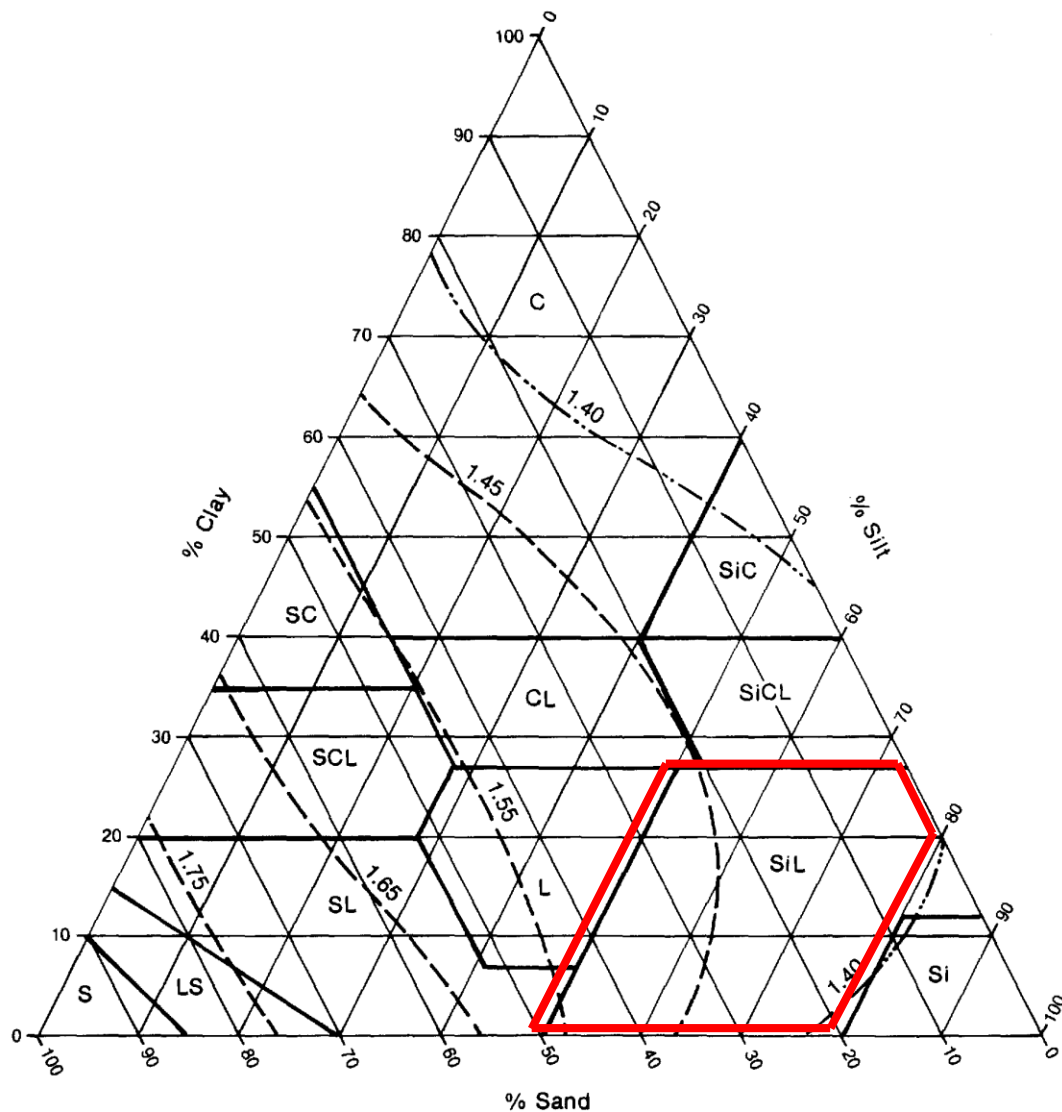

Figure 3.2 Growth-limiting bulk density textural triangle.

*Only applicable on soils with < 3% organic matter, < 10% coarse fragments. For silty loam (SiL), the growth-limiting bulk density is about 1.40 to 1.50 (the red box) (Daddow and Warrington 1983).

Bioretention soil should be within the soil texture class of loamy sand or sandy loam due to their infiltration rates ranging from 0.52 – 2.41 inches/hour (PGCM 2007).

However, loamy sand and sandy loam have relatively low available water properties as shown in Figure 3.3, thus it is good practice to add organic matter or other improvements to these soils for good plant growth. Figure 3.3 uses units of inches of water per foot of soil, which is a common unit for measuring moisture in soil, these units can be converted to percent moisture by dividing the inches of water by 12 and multiplying by 100. Figure 3.4 shows that increasing the organic matter of soil increases available water. Media in bioretention cells should have 1.5 to 3 percent organic matter (ISMM 2009), and thus, should be able to provide 0.1 to 0.3 ft³ of water for plant growth per ft³ media.

The addition of compost or other types of organic matter is important for plant growth and field capacity. For silt loam with rubber column (SLR) media, the field capacity measured was 19.77% or 2.37 inches of water per foot of soil, and the permanent wilting point measured was 13.32% or 1.6 inches of water per foot of soil, which are lower and higher than those shown in Figure 3.3, respectively. The rubber chips added to the silty loam narrowed the range between the field capacity and permanent wilting point, decreasing the available moisture percentage. Therefore, the rubber chips did not add any moisture benefits to the media as expressed in the silty loam sample. The best media, based on moisture characteristics, were the compost rubber mixture followed by the silty loam rubber mixture. The available moisture of rubber (R, 0.99%) and the sand rubber (SR, 0.4%) mixtures were around 1/6 to 1/15 of that of the silty loam rubber (SLR, 6.45%) or compost rubber (CR, 6.18%) mixtures (Table 3.10). The result of the compost rubber mixture having the best moisture characteristics shows the benefits of amending soil media with compost.

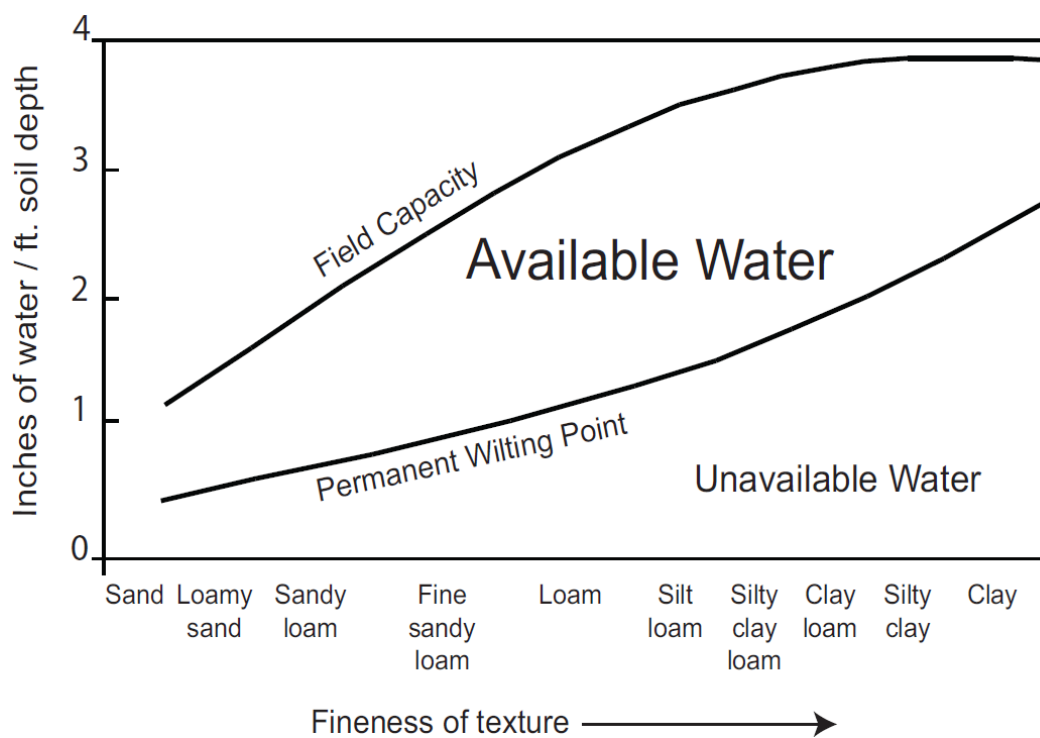

Figure 3.3 General relationship between soil moisture and texture (USDA 2008)

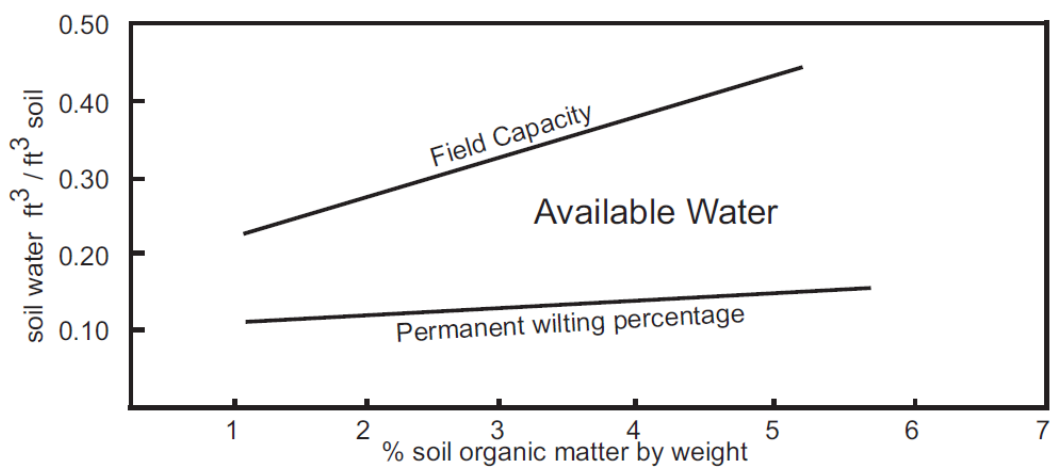

Figure 3.4 Effect of increasing organic matter on available water (USDA 2008)

3.3.4 Column Tests by Loading Synthetic Highway Storm Water Runoff

Results and analysis of the 10 weeks of reactor testing were compared against other studies and Nebraska Department of Environmental Quality (NDEQ) numerical stream standards (Table 3.11). Numerical stream standards commonly do not play a role in MS4 regulations because the use of BMPs replaces the need for numerical standards in the regulations. Comparison with the NDEQ stream standards was still done to check effluent and influent concentrations from the reactors to see if the media were improving the concentrations or adding more pollutants above stream standard concentrations. NDEQ stream standards are based on water hardness because the calculated concentration is for dissolved metals. Because of the methods used in analysis and preservation of the lab samples, the lab samples were obtained by a modified method for total metals and could be considered total metal concentrations (APHA et al. 2012).

Table 3.11 NDEQ stream standard concentrations (NDEQ 2006)

Constituent	Concentration ($\mu\text{g/l}$)^a	Condition
Fe	1,000	chronic
Ni	842	acute
Cu	25.8	acute
Zn	211	acute
Pb	136	acute
NO ₃	10,000	Drinking water standard

^a Concentrations for metals calculated with NDEQ equations using a concentration of 200 mg/L CaCO₃ water hardness.

3.3.4.1 Analysis of Control Checks

The control checks done on the tap water and roadway sediment are shown in

Table 3.12. The tap water used added a trace amount (in the range of $\mu\text{g/L}$) of iron, copper, zinc, and nitrate to the influent to be used in this study. The roadway sediment also contained concentrations of iron, copper, zinc, and nitrate, most notably more than 3,000 $\mu\text{g/g}$ of iron and more than 100 $\mu\text{g/g}$ of zinc. Chromium and silver were found in the sediment analysis (data not shown in Table 3.12) but were not detected in the influent or effluent testing of the reactors. Table 3.13 shows some typical sources for roadway constituents such as chromium and nickel.

Table 3.12 Concentrations of constituents in tap water and roadway sediment

Constituent	Tap water ($\mu\text{g/l}$)	Roadway Sediment ($\mu\text{g/g}$)	Instrument DL ($\mu\text{g/l}$)
Cr	< DL ^a	12.148	12.362
Fe	73.122	3054.209	5.198
Ni	< DL	7.255	3.373
Cu	6.294	28.076	2.100
Zn	8.574	113.842	2.201
Ag	< DL	31.982	7.436
Cd	< DL	< DL	1.228
Sb	< DL	< DL	8.404
Pb	< DL	19.076	3.794
NO ₃	589	185	276

^a < DL = lower than detection limit.

3.3.4.2 Metals Leached in Column Tests

Iron. Iron was added to the synthetic storm water via added sediment and tap water. The sand rubber reactors (SR1 and SR2) had the best treatment of iron of the four mixtures, with treatment efficiencies ranging from about 10 to 80 % (Table 3.15) in the

first 9 weeks. The compost rubber reactors (CR1 and CR2) had the worst removal efficiency; they leached iron with negative efficiencies ranging from about -30 to -600 % (Table 3.15). The removal efficiency in the 10th week for SR1 and SR2 are difficult to explain, but it can be from treatment breakthrough or short circuiting of the reactors. Some of the effluent concentrations from the compost rubber reactors (CR1 and CR2) as shown in Table 3.14 were above NDEQ stream standards for iron which are 1,000 µg/L chronic conditions for a 24 h average (Table 3.11). Iron is not a major constituent of concern for storm water treatment; therefore no other comparative studies were found.

Table 3.13 Roadway constituent sources (Stansbury et al. 2012)

Constituent	Primary source
Particulates	Pavement wear, vehicles, atmosphere, maintenance, snow/ice abrasives, sediment disturbance.
Nitrogen, Phosphorus	Atmosphere, roadside fertilizer use, sediments.
Lead	Leaded gasoline, tire wear, lubricating oil and grease, bearing wear, atmospheric fallout.
Zinc	Tire wear, motor oil, grease.
Iron	Auto body rust, steel highway structures, engine parts.
Copper	Metal plating, bearing wear, engine parts, brake lining wear, fungicides and insecticides use.
Cadmium	Tire wear, insecticide application.
Chromium	Metal plating, engine parts, brake lining wear.
Nickel	Diesel fuel and gasoline, lubricating oil, metal plating, brake lining wear, asphalt paving.
Sodium, Calcium	Deicing salts, grease.
Chloride	Deicing salts.
Rubber	Tire wear

Table 3.14 Iron concentrations (in µg/L) in influent and effluent of columns

Column ^a	Week									
	1	2	3	4	5	6	7	8	9	10
SLR1	397	276	379	327	96	325	238	414	557	345
SLR2	412	325	279	297	105	373	309	375	391	248
SR1	212	152	149	143	103	118	136	149	142	130
SR2	233	127	137	137	112	132	161	147	126	142
CR1	1641^b	2242	1351	1083	404	570	310	374	250	157
CR2	2658	3315	831	1658	995	401	485	467	340	195
R1	483	367	331	224	270	627	216	294	190	119
R2	457	305	319	290	263	668	253	254	254	152
Influent	651	722	388	226	286	382	214	230	158	119

^a R = rubber, CR = compost/rubber, SR = sand/rubber, SLR = silty loam/rubber

^b #'s in bold (red) indicate that the sample's concentrations were above the NDEQ stream standards described.

Table 3.15 Iron treatment efficiencies (%) of different columns

Column ^a	Week									
	1	2	3	4	5	6	7	8	9	10
SLR1	39.1	61.8	2.4	-44.5	66.4	14.9	-11.2	-80.0	-251.7	-190.1
SLR2	36.7	55.0	28.1	-31.1	63.1	2.5	-44.6	-63.1	-146.9	-108.7
SR1	67.4	78.9	61.6	36.9	64.0	69.0	36.3	35.4	10.6	-9.5
SR2	64.3	82.4	64.6	39.6	60.7	65.3	24.7	36.0	20.2	-19.6
CR1	-152.0	-210.5	-248.3	-378.1	-41.4	-49.2	-45.0	-62.4	-57.7	-32.2
CR2	-308.2	-359.2	-114.3	-632.1	-248.3	-4.9	-126.8	-102.6	-114.7	-63.8
R1	25.8	49.1	14.6	1.3	5.5	-64.1	-1.0	-27.6	-20.2	0.0
R2	29.8	57.8	17.8	-28.1	8.0	-74.8	-18.4	-10.2	-60.3	-28.1

^aR = rubber, CR = compost/rubber, SR = sand/rubber, SLR = silty loam/rubber

Nickel. Trace amounts of nickel leached from all reactors during testing. Most values for nickel were below the Method Detection Limit (see appendix C for QA/QC). The NDEQ acute stream standard for nickel is 842 µg/L at 200 mg/L CaCO₃ water hardness, and all nickel values found during testing in this study were below 11 µg/L. The compost rubber reactors (CR1 and CR2) leached the most nickel and the rubber reactors

(R1 and R2) leached the least (Tables 3.16 and 3.17). Nickel is not a major constituent of concern for storm water treatment, and thus, no other comparative studies were found.

Table 3.16 Nickel concentrations (in µg/L) in influent and effluent of columns

Column ^b	week									
	1	2	3	4	5	6	7	8	9	10
SLR1	4.02	<i>2.90^a</i>	<i>2.70</i>	<i>2.15</i>	<i>1.78</i>	3.47	<i>2.44</i>	<i>2.98</i>	<i>2.60</i>	<i>1.54</i>
SLR2	4.04	<i>3.06</i>	<i>2.61</i>	<i>2.86</i>	<i>2.10</i>	3.72	<i>2.42</i>	<i>2.92</i>	<i>2.55</i>	<i>1.64</i>
SR1	4.60	<i>3.10</i>	3.91	<i>2.70</i>	<i>2.95</i>	3.69	<i>2.42</i>	3.58	<i>2.77</i>	<i>2.58</i>
SR2	5.08	<i>3.33</i>	<i>2.89</i>	<i>3.02</i>	<i>3.26</i>	3.91	<i>2.63</i>	3.58	<i>2.89</i>	<i>2.68</i>
CR1	7.28	7.69	5.67	4.45	<i>2.57</i>	<i>3.20</i>	<i>1.78</i>	<i>2.41</i>	<i>2.03</i>	<i>1.71</i>
CR2	10.96	10.02	<i>3.33</i>	7.56	5.07	4.38	<i>2.46</i>	<i>2.91</i>	<i>2.03</i>	<i>1.58</i>
R1	4.29	3.46	<i>2.08</i>	<i>2.17</i>	<i>1.88</i>	<i>3.36</i>	<i>1.93</i>	<i>2.33</i>	<i>2.04</i>	<i>1.77</i>
R2	3.72	<i>2.93</i>	<i>2.03</i>	<i>1.92</i>	<i>1.79</i>	<i>3.09</i>	<i>1.80</i>	<i>2.25</i>	<i>2.19</i>	<i>1.76</i>
Influent	3.85	3.88	<i>2.06</i>	<i>2.03</i>	<i>1.58</i>	<i>3.17</i>	<i>1.65</i>	<i>2.06</i>	<i>1.27</i>	<i>1.37</i>

^a #'s in italics indicate concentrations below the method detection limits.

^bR = rubber, CR = compost/rubber, SR = sand/rubber, SLR = silty loam/rubber

Table 3.17 Nickel treatment efficiencies (%) of different columns

Column ^a	week									
	1	2	3	4	5	6	7	8	9	10
SLR1	-4.4	25.4	-30.9	-5.7	-12.9	-9.5	-47.9	-44.5	-105.3	-12.1
SLR2	-5.0	21.1	-26.6	-40.8	-33.1	-17.3	-46.7	-41.4	-101.7	-20.0
SR1	-19.5	20.2	-89.7	-32.7	-86.9	-16.5	-46.7	-73.6	-118.7	-88.1
SR2	-32.1	14.3	-40.4	-48.6	-106.6	-23.3	-59.4	-73.5	-128.2	-95.6
CR1	-89.1	-98.1	-175.2	-118.9	-62.6	-1.1	-7.6	-16.5	-60.7	-24.4
CR2	-184.8	-158.1	-61.6	-271.5	-221.2	-38.3	-49.2	-40.8	-60.2	-15.3
R1	-11.4	10.9	-1.0	-6.8	-19.2	-6.0	-16.8	-12.8	-61.1	-28.7
R2	3.4	24.7	1.4	5.4	-13.3	2.6	-9.3	-8.8	-72.8	-28.2

^aR = rubber, CR = compost/rubber, SR = sand/rubber, SLR = silty loam/rubber

Copper. Copper was added to the synthetic storm water from the roadway sediment, tap water, and as an added constituent (Table 3.1). The sand rubber reactors (SR1 and SR2) had the best treatment efficiencies, ranging from ~72 to 92% (Table 3.19). The results from the silty loam rubber (SLR1 and SLR2) and sand rubber (SR1 and SR2) reactors are similar to other testing efficiencies, ranging from 43 to 99 % for copper removal in ten other studies (Ming-Han et al. 2010). The rubber reactors (R1 and R2) had the worst treatment efficiency, ranging from ~12 to -30%. The NDEQ acute stream standard concentration for copper is 25.8 µg/L at 200 mg/L CaCO₃ water hardness. Influent and effluent from the rubber and compost rubber reactors were above this stream standard for a majority of the testing period.

Table 3.18 Copper concentrations (in µg/L) in influent and effluent of columns

Column ^a	week									
	1	2	3	4	5	6	7	8	9	10
SLR1	29.64^b	5.73	6.90	6.98	3.13	5.07	3.97	5.58	16.14	6.28
SLR2	31.94	10.17	7.58	3.61	3.49	4.32	5.59	7.74	6.07	4.38
SR1	10.41	4.85	4.85	2.69	3.01	4.16	4.77	5.10	4.03	3.77
SR2	14.08	6.08	5.37	3.28	4.20	5.32	5.81	6.06	4.59	4.03
CR1	73.13	37.81	35.80	6.12	19.78	16.11	18.16	15.21	10.46	6.47
CR2	82.43	44.69	25.00	6.91	32.74	21.18	25.97	22.81	17.27	9.56
R1	98.17	39.31	28.56	30.94	24.50	25.71	34.78	31.43	28.24	16.27
R2	99.74	37.86	28.86	32.25	24.60	23.72	38.25	32.57	33.70	16.68
Influent	111.67	47.33	30.82	33.95	25.55	25.25	42.31	31.62	21.95	14.65

^aR = rubber, CR = compost/rubber, SR = sand/rubber, SLR = silty loam/rubber

^b #'s in bold indicate that the sample's concentrations were above the NDEQ stream standards described.

Zinc. The silty loam rubber reactors (SLR1 and SLR2) had the best treatment for zinc and the rubber reactors (R1 and R2) leached the most zinc (Table 3.20). The silty loam reactors were the only reactors that had similar treatment efficiencies to other studies which showed a range of treatment from 27 to 98 % from ten other studies (Ming-Han et al. 2010). All other reactors except silty loam leached large amounts of zinc, ranging from 100 to 1,600 % of the influent concentration (Table 3.21). The acute NDEQ stream standard for zinc is 211 µg/L at 200 mg/L CaCO₃ water hardness. The reactor influent and silty loam reactors effluent were all below this stream standard, but all other reactor effluents were above it as shown in Table 3.20.

Table 3.19 Copper treatment efficiencies (%) of different columns

Column ^a	week									
	1	2	3	4	5	6	7	8	9	10
SLR1	73.5	87.9	77.6	79.4	87.7	79.9	90.6	82.3	26.5	57.1
SLR2	71.4	78.5	75.4	89.4	86.3	82.9	86.8	75.5	72.4	70.1
SR1	90.7	89.7	84.3	92.1	88.2	83.5	88.7	83.9	81.6	74.2
SR2	87.4	87.2	82.6	90.4	83.5	78.9	86.3	80.8	79.1	72.5
CR1	34.5	20.1	-16.2	82.0	22.6	36.2	57.1	51.9	52.4	55.8
CR2	26.2	5.6	18.9	79.6	-28.1	16.1	38.6	27.9	21.3	34.7
R1	12.1	16.9	7.4	8.9	4.1	-1.8	17.8	0.6	-28.6	-11.0
R2	10.7	20.0	6.4	5.0	3.7	6.0	9.6	-3.0	-53.6	-13.9

^aR = rubber, CR = compost/rubber, SR = sand/rubber, SLR = silty loam/rubber

Lead. The sand rubber (SR1 and SR2) reactors had the best treatment efficiencies for lead, ranging from ~97 to 100 % lead removal. In contrast, the rubber reactors (R1 and R2) had the worst treatment efficiencies, ranging from ~30 to -50 %

removal (Table 3.23). The sand rubber (SR) and silty loam rubber (SLR) reactors both had treatment efficiencies similar to the one reported in the literature that showed a range of efficiencies from 54 to 95 % for ten other studies (Ming-Han et al. 2010). Some lead concentrations of the effluent from the silty loam rubber and sand rubber reactors were below method detection limits (see appendix C). This was due to the high treatment efficiencies of those reactors. The NDEQ acute stream standard for lead is 136 µg/L at 200 mg/L CaCO₃ water hardness. For the first 5 weeks of testing the influent, rubber, and compost rubber reactors were over the NDEQ stream standard.

Table 3.20 Zinc concentrations (in µg/L) in influent and effluent of columns

Column ^a	week									
	1	2	3	4	5	6	7	8	9	10
SLR1	75	37	74	111	75	71	94	131	143	59
SLR2	113	49	73	120	108	134	140	170	163	130
SR1	226^b	143	251	380	372	433	381	505	482	387
SR2	204	106	179	342	294	340	344	398	371	281
CR1	611	641	452	373	176	199	147	154	121	93
CR2	909	1189	307	552	322	449	209	192	123	95
R1	623	512	286	405	372	563	441	456	351	310
R2	323	299	173	326	294	523	365	408	379	324
Influent	164	176	34	34	35	174	158	149	121	136

^aR = rubber, CR = compost/rubber, SR = sand/rubber, SLR = silty loam/rubber

^b #'s in bold indicate that the sample's concentrations were above the NDEQ stream standards described.

Table 3.21 Zinc treatment efficiencies (%) of different columns

Column ^a	week										
	1	2	3	4	5	6	7	8	9	10	
SLR1	54.6	79.0	-115.7	-228.6	-	114.6	59.0	40.7	11.6	-17.7	56.6
SLR2	31.5	72.4	-114.4	-256.6	-	205.9	22.9	11.3	-13.9	-34.3	4.3
SR1	-37.5	18.5	-633.4	1028.0	-	958.4	149.1	141.2	239.6	296.6	184.4
SR2	-24.2	40.0	-424.0	-913.6	-	735.5	-96.0	117.7	167.6	205.3	106.6
CR1	-	-	-	-	-	-	-14.3	7.0	-3.7	0.5	32.0
CR2	-	-	-	-	-	-	-	-32.3	-28.8	-1.5	30.6
R1	-	-	-	-	-	-	-	-	-	-	-
R2	-	-	-	-	-	-	-	-	-	-	-
	279.1	191.5	-735.7	1099.3	958.4	224.4	179.2	206.3	188.7	127.6	
	-96.6	-70.1	-407.3	-867.3	735.5	201.2	131.4	173.9	211.7	138.1	

^aR = rubber, CR = compost/rubber, SR = sand/rubber, SLR = silty loam/rubber

Table 3.22 Lead concentrations (in µg/L) in influent and effluent of columns

Column ^c	week									
	1	2	3	4	5	6	7	8	9	10
SLR1	188.76^b	6.12	20.70	42.38	7.07	<i>1.80</i>	<i>3.17</i>	<i>2.03</i>	21.95	10.61
SLR2	199.66	25.11	34.58	15.77	12.70	<i>2.74</i>	4.46	<i>2.56</i>	<i>3.12</i>	4.10
SR1	50.37	<i>0.00^a</i>	7.55	<i>2.43</i>	5.18	<i>2.15</i>	<i>2.88</i>	<i>1.02</i>	<i>0.00</i>	<i>0.00</i>
SR2	84.25	<i>1.72</i>	5.94	<i>3.62</i>	6.82	<i>2.20</i>	<i>3.61</i>	<i>1.20</i>	<i>0.00</i>	<i>1.15</i>
CR1	439.07	121.08	274.59	277.67	133.10	26.95	20.80	7.34	7.36	8.28
CR2	516.24	151.05	158.61	326.23	247.76	43.73	37.14	15.77	16.30	17.45
R1	536.61	121.28	244.07	252.71	243.88	49.53	57.94	23.82	46.59	44.27
R2	553.89	120.73	244.62	273.61	242.19	47.52	59.52	18.01	50.54	47.74
Influent	626.75	164.93	347.56	344.84	323.75	50.55	69.31	15.35	32.38	51.42

^a #'s in italic indicate concentrations below method detection limits.

^b #'s in bold indicate that the sample's concentrations were above the NDEQ stream standards described.

^cR = rubber, CR = compost/rubber, SR = sand/rubber, SLR = silty loam/rubber

Table 3.23 Lead treatment efficiencies (%) of different columns

Column ^a	week									
	1	2	3	4	5	6	7	8	9	10
SLR1	69.9	96.3	94.0	87.7	97.8	96.4	95.4	86.8	32.2	79.4
SLR2	68.1	84.8	90.1	95.4	96.1	94.6	93.6	83.3	90.4	92.0
SR1	92.0	100.0	97.8	99.3	98.4	95.7	95.8	93.3	100.0	100.0
SR2	86.6	99.0	98.3	99.0	97.9	95.6	94.8	92.2	100.0	97.8
CR1	29.9	26.6	21.0	19.5	58.9	46.7	70.0	52.2	77.3	83.9
CR2	17.6	8.4	54.4	5.4	23.5	13.5	46.4	-2.7	49.7	66.1
R1	14.4	26.5	29.8	26.7	24.7	2.0	16.4	-55.2	-43.9	13.9
R2	11.6	26.8	29.6	20.7	25.2	6.0	14.1	-17.3	-56.1	7.2

^aR = rubber, CR = compost/rubber, SR = sand/rubber, SLR = silty loam/rubber

3.3.4.3 Other Water Quality Parameters

Nitrate. Nitrate was measured for all ten weeks but only the last five weeks of testing provide reliable data due to problems in methods used (Table 3.24). The problems experienced in methodology were sample preservation, sample dilution, and constituents of concern. The preservation of the samples with sulfuric acid raised the sulfate concentrations in the samples and the HPLC testing. High sulfate concentration interfered with nitrate detection in the HPLC testing. Initial sample dilution was thought to be 300:1 because of the issue with preservation giving false values of nitrate in the g/l range. Finally initial thoughts were to check for all anions detectable by the HPLC instrument, which lead to diluting samples to levels needed for accurate detection of all initial constituents of concern. At week five the conclusion was that the samples did not

need acid preservation but only refrigeration and analysis within 48 hours, no dilution was required, and the only constituent of concern was nitrate.

Values for nitrate for the influent, rubber (R1 and R2), and sand rubber reactors (SR1 and SR2) were below method detection limits. The sand rubber reactors had the best treatment efficiencies for nitrate, ranging from about 11 to 40 % removal as shown in Table 3.25. Only the treatment efficiencies for sand rubber (SR1 and SR2) and rubber (R1 and R2) were similar to the literature which showed a treatment range of negative 5 to 95 percent removal of nitrate from ten different studies (Ming-Han et al. 2010). Nitrate leached from the silty loam rubber and compost rubber reactors, ranging from 10 to 1200 % more than the influent concentration. However, all concentrations throughout testing were below the NDEQ stream standard and drinking water standard for nitrate which is 45 mg NO₃/L (10 mg NO₃-N/L).

Table 3.24 Nitrate concentrations (in mg NO₃-NO₃/L) for reactors

Column ^b	week				
	6	7	8	9	10
SLR1	0.455	0.411	0.425	0.407	0.650
SLR2	0.307	0.354	0.342	0.514	0.620
SR1	<i>0.173^a</i>	<i>0.164</i>	<i>0.097</i>	<i>0.173</i>	<i>0.227</i>
SR2	<i>0.177</i>	<i>0.163</i>	<i>0.094</i>	<i>0.173</i>	0.326
CR1	0.996	0.597	0.402	0.514	0.528
CR2	1.860	1.757	1.667	1.704	2.281
R1	0.336	<i>0.210</i>	<i>0.122</i>	<i>0.202</i>	0.374
R2	<i>0.244</i>	<i>0.208</i>	<i>0.115</i>	<i>0.207</i>	0.325
Influent	<i>0.223</i>	<i>0.214</i>	<i>0.123</i>	<i>0.235</i>	0.368

^a #'s in italics indicate concentrations below reliable quantification limits.

^bR = rubber, CR = compost/rubber, SR = sand/rubber, SLR = silty loam/rubber

Table 3.25 Nitrate treatment efficiencies (%) of different columns

Column ^a	week				
	6	7	8	9	10
SLR1	-104.38	-92.33	-245.23	-72.75	-76.52
SLR2	-37.78	-65.82	-177.38	-118.11	-68.47
SR1	22.34	23.04	21.60	26.68	38.24
SR2	20.44	23.74	24.11	26.33	11.39
CR1	-347.30	-179.66	-226.21	-118.46	-43.29
CR2	-735.10	-722.43	-1253.10	-623.68	-519.31
R1	-50.85	1.49	1.17	14.41	-1.64
R2	-9.47	2.76	7.06	12.17	11.76

^aR = rubber, CR = compost/rubber, SR = sand/rubber, SLR = silty loam/rubber

Total suspended solids. The sand rubber reactors (SR1 and SR2) had the best TSS removal, ranging from ~88 to 98 %. All reactors had positive removal rates except the compost rubber reactors (CR1 and CR2), which leached up to 450% of the influent concentration but improved over time to between 50 to 80% removal. TSS removal was reported ranging from -170 to 60% from ten studies (Ming-Han et al. 2010).

Table 3.26 TSS concentrations (in mg/L) in influent and effluent of columns

Column ^a	week									
	1	2	3	4	5	6	7	8	9	10
SLR1	28.0	11.0	15.2	45.3	11.0	24.0	36.7	32.7	154.0	35.3
SLR2	42.3	46.5	25.0	14.0	25.5	24.0	32.7	26.7	36.0	38.0
SR1	11.8	3.8	10.3	3.3	2.7	4.3	3.0	3.5	4.3	7.0
SR2	15.0	4.5	7.3	3.5	3.5	6.5	5.0	5.7	3.3	6.2
CR1	744.0	768.0	968.0	544.0	144.0	116.0	52.0	28.0	-8.0	20.0
CR2	1344.0	1440.0	464.0	1124.0	728.0	396.0	132.0	108.0	60.0	56.0
R1	82.8	126.0	114.7	80.0	99.0	100.0	112.0	102.0	87.0	94.0
R2	59.2	86.7	105.0	86.0	94.0	113.0	111.0	99.0	119.0	127.0
Influent	132.3	261.3	176.0	168.0	172.0	140.0	137.3	134.7	132.7	102.0

^aR = rubber, CR = compost/rubber, SR = sand/rubber, SLR = silty loam/rubber

Table 3.27 Total suspended solids treatment efficiencies (%) of different columns

Column ^a	Week									
	1	2	3	4	5	6	7	8	9	10
SLR1	78.8	95.8	91.4	73.0	93.6	82.9	73.3	75.7	-16.1	65.4
SLR2	68.0	82.2	85.8	91.7	85.2	82.9	76.2	80.2	72.9	62.7
SR1	91.1	98.6	94.2	98.1	98.4	97.0	97.8	97.4	96.8	93.1
SR2	88.7	98.3	95.9	97.9	98.0	95.4	96.4	95.7	97.6	93.9
CR1	-462.2	-193.9	-450.0	-223.8	16.3	17.1	62.1	79.2	106.0	80.4
CR2	-915.6	-451.0	-163.6	-569.0	-323.3	-182.9	3.9	19.8	54.8	45.1
R1	37.4	51.8	34.8	52.4	42.4	28.6	18.4	24.3	34.4	7.8
R2	55.3	66.8	40.3	48.8	45.3	19.3	19.2	26.5	10.3	-24.5

^aR = rubber, CR = compost/rubber, SR = sand/rubber, SLR = silty loam/rubber

Chemical oxygen demand. COD was analyzed for the final 3 weeks of testing and is shown in Table 3.28. COD leached out of all reactors and in only 1 of the 3 weeks of testing COD was detected in the influent. COD in storm water is estimated to have a typical concentration of 75 mg-O/L (U.S. EPA 1999). Some sources for the leaching of COD from the reactors may be the organic matter in the compost or the silty loam materials. Also with COD testing only occurring for the last 3 weeks some accumulation may have happened during the test period. Most other storm water studies have not focused on COD.

3.3.5 Discussion

Each media mixture tested has benefits and draw-backs. When looking at the results from the physical attributes tested, a media with less than a 24 hour drawdown time, available moisture for plant growth, and a bulk density that does not inhibit plant growth may be the most important attributes. In this study, all media tested had sufficient drawdown times to drain within 24 h. Therefore, the media with the best treatment of

storm water will over-rank the drawdown times. Available moisture may be as important as treatment efficiencies. The bench-scale columns did not include plant growth which could improve treatment efficiencies and change bulk densities and drawdown times due to root establishment. Vegetation has been found to be beneficial in nutrient removal in porous landscape detention basin (PLDB) in Colorado (Kocman et al. 2011). The two best media for available moisture in the current study were compost rubber (CR) and silty loam rubber (SLR). In addition, previous research has shown that organic matter of 1.5 to 3 percent in any BMP media adds important qualities for plant growth (ISMM 2009). Plant growth limiting bulk densities may be prevented by adding alternative materials or adding organic media such as mulch although rubber chips did not improve the growth limiting bulk density of silty loam.

Table 3.28 COD concentrations (in mg-O/L) in influent and effluent of columns

Column ^c	week		
	8	9	10
SLR 1	35	30	35
SLR 2	235	25	100
SR 1	15	20	205
SR 2	N/A ^a	N/A	80
CR 1	75	105	95
CR 2	195	155	215
R 1	65	55	55
R 2	45	60	55
IN	45	<DL ^b	<DL

^aBad data from boiling over of samples during digestion

^bbelow method detection limits see appendix C for calibration curve

^cR = rubber, CR = compost/rubber, SR = sand/rubber, SLR = silty loam/rubber

From synthetic storm water testing, it was found that the sand rubber mixture (SR) provided the best treatment for iron, copper, lead, nitrate, and TSS. The silty loam reactors (SLR) were the best at treating zinc and second best at treating iron, copper, lead, and TSS. The compost rubber mixture (CR) had the worst treatment of iron, nickel, nitrate, and TSS, most likely due to leaching of fine particles. The rubber reactors were tested to check for leaching from the media itself. The rubber reactors leached the most copper, lead, and zinc. No other similar research was found regarding treatment efficiencies of rubber chip mediated soils at 50 percent concentration of rubber chips.

3 to 4 mesh (0.365"–0.187") rubber chips may not be a good alternative medium on their own for the treatment in storm water in BMPs. The rubber chip medium itself could be a source of lead, copper, and zinc which may increase concentrations in the runoff instead of treating and removing constituents. In addition, rubber chips did not improve any moisture characteristics of the soil or the growth limiting bulk density of the soils tested. Other light weight or porous filler materials could be considered in place of rubber chips. This research focused on testing 50 percent rubber mixture with 50 percent traditional media. Other research tested a BMP soil mixture supplemented with 8 percent shredded tires (Kocman et al. 2011). The use of 8 percent shredded tire was based on cost/availability, leaching, flow rate, and seed germination. The deciding factor for 8 percent was based on flow rate restrictions. One other major finding from Kocman et al. (2011) is that shredded tire increased the life span of their BMP but decreased the filtering capacity for zinc.

Although the sand rubber reactors had the best treatment, it had a low available moisture and field capacity and also had high bulk density which was not the best mixture for plant growth. Without good available moisture and field capacity, good plant establishment may not be possible, which would inhibit the benefits of having biomass and plants to aid in storm water treatment. It could be suggested that BMP media be installed in layers with the top layer, or root zone (i.e. 6”), excluding the 3 inches of mulch, focusing on beneficial plant growth attributes such as good growth bulk density values, good available moisture, and good moisture holding capacity as shown by the compost rubber mixture. The remaining depth should focus on filtration and storm water constituent treatment based on treatment efficiencies tested from the added constituents shown by the sand rubber mixture. With this in mind, our results indicate that 6 inches of compost rubber could be placed on top of a depth of sand rubber to allow for a plant growth zone for roots and a storm water treatment zone below the growth layer.

3.4 Conclusions

Several conclusions can be drawn from the work conducted in this chapter:

- The best medium mixtures based on physical properties were the silty loam rubber and compost rubber mixtures based primarily on moisture qualities and bulk densities. All medium types tested had sufficient drawdown times.
- The best medium mixture for storm water constituent treatment was the sand rubber mixture, and the second best was the silty loam rubber mixture. The rubber

and compost rubber mixtures showed the most leaching which added storm water constituents to the effluent.

- The benefit of adding rubber chips as a low cost alternative material for filler did not outweigh heavy metals (e.g., Pb, Cu, Zn) leached from the reactors. Also the rubber chips did not add any great physical benefit to the media.
- Because physical and chemical treatment attributes of different media are different it could be suggested that media should be layered with the top 6 inches focusing on plant establishment characteristics and the continuing depth focusing on filtration and treatment of storm water constituents.

Chapter 4 Conclusions and Recommendations

4.1 Conclusions

Several conclusions can be drawn from this research as a whole to develop and evaluate roadside BMPs to treat highway runoff.

- Sedimentation within BMPs is a crucial factor that cannot be overlooked during construction and after the construction period. Construction periods should be kept as short as possible to minimize the chance of rain events during construction. After the construction phase, erosion control measures should be placed and maintained as soon as possible until the contributing watershed is stabilized with vegetation.
- From Image J analysis, the compost/47-B test cell had the best vegetative performance. In contrast the loam/sand/wood mulch test cell had the worst vegetative growth of the four cells. All cells had between 48 and 64 percent green in the best images.
- Although only vegetative monitoring was accomplished in this study, a monitoring matrix is important for further methods of reporting the long-term use and efficiency of these BMPs. Monitoring methods should focus primarily on clogging and treatment of total suspended solids.

- All media studied have adequate drawdown times. The best media based on physical properties were the silty loam rubber and compost loam mixtures based primarily on moisture qualities and bulk densities.
- The best medium mixture for storm water constituent treatment was the sand rubber mixture and the second best was the silty loam rubber mixture. The rubber and compost rubber mixtures showed leaching which added storm water constituents to the effluent.
- The benefit of adding rubber chips as a low cost alternative material for filler did not outweigh the addition of lead copper and zinc from leaching. Also the rubber chips did not add any significant physical benefit to the media such as improving growth limiting bulk density, moisture holding capacity, or available moisture.
- Because physical and chemical treatment attributes of different media are different, it could be suggested that media should be layered with the top layer or root zone focusing on plant establishment characteristics and the continuing depth focusing on filtration and treatment of storm water constituents.

4.2 Recommendations

With the presentation of this research and conclusions, some recommendations can be made as follows:

- Because of the clogging in the field BMPs and since that clogging will eventually happen to all BMPs, research on the best and most cost-efficient methods to unclog BMPs could be done at the site.
- More research can be done on alternative light-weight materials that can reduce the cost of BMP materials. Also, some of these materials may supplement the treatment process of storm water constituents or improve qualities of the engineered media for plant growth.
- Because rubber chips are a waste material, using it in smaller amounts as a filler material to find a use for the waste material could be done. To do this the optimum percent of the BMP soil mixture that can be rubber chips should be tested. Also, different size rubber chips may have different effects on the media and the leaching of metals from the rubber chips.
- More research can be done to find optimum BMP soils for plant growth. This could prove beneficial if these medium mixtures can be found and paired with plants that can bioaccumulate metals. Ultimately the soil can be a loose structure for roots and vegetation like a trickling filter structure. Also, a healthy plant growth and structure could improve the longevity of the BMP.
- Additional future column tests should include a long term set of flushes with a single final permeability and sample test simulate long term use of the BMP and its long-term treatment capability.

References

APHA, AWWA, and WPCF. (2012). *Standard methods for the examination of water and wastewater*. Washington, D.C. American Public Health Association, 2012.

Bowders, J. J., Tan, J. P., and Daniel, D. E. (1997). "Expanded clay and shale aggregates for leachate collection systems." *J. Geotech. Geoenviron. Eng.*, 123(11), 1030–1034.

CWA (1977a). "Clean Water Act of 1977." *Rep. No. 33 U.S.C § 1312*, <http://www.law.cornell.edu/uscode/text/33/1312> (Accessed Nov. 2012).

Daddow, R. L., and Warrington, G. E. (1983). *Growth-limiting soil bulk densities as influenced by soil texture*. Rep. No. WSDG-TN-00005, Watershed systems development group USDA forest service, 3825 east Mulberry street Fort Collins, Colorado 80524.

Davis, A. P., Shokouhian, M., Sharma, H., and Minami, C. (2001). "Laboratory study of biological retention for urban stormwater management." *Water Environ. Res.*, 73(1), 5–14.

FHWA. (2009). *Hydraulic Engineering Circular No. 22, Third Edition : Urban Drainage Design Manual*. Rep. No. FHWA-NHI-10-009 HEC 22, Federal Highway Administration, National Highway Institute 4600 N. Fairfax Dr., Suite 800 Arlington, Virginia 22203.

FHWA. (2005). *Hydraulic Engineering Circular No. 15, Third Edition: Design of Roadside Channels with Flexible Linings*. Rep. No. FHWA-NHI-05-114 HEC 15, Federal Highway Administration, Federal Highway Administration National Highway Institute 4600 North Fairfax Drive Suite 800 Arlington, Virginia 22203.

Field, R., Tafuri, A., Muthukrishnan, S., Acquisto, B., and Selvakumar, A. (2006). *The Use of Best Management Practices (BMPs) in Urban Watersheds*. DEStech Publications, Lancaster, PA.

Flint, K. R., and Davis, A. P. (2007). "Pollutant mass flushing characterization of highway stormwater runoff from an ultra-urban area." *Journal of Environmental Engineering*, 133(6), 616–626.

Gupta, R. S. (2008). *Hydrology and Hydraulic Systems* (3rd ed.). Long Grove: Waveland Press, Inc., Long Grove, Illinois.

Hartsig, T., and Szatko, A. (2012). *Performance assessment of two stormwater best management practices for infiltration, water quality, and vegetative growth.*

http://water.unl.edu/c/document_library/get_file?uuid=cbb02800-6f34-4246-8c87-6a4fb59b0fbf&groupId=468067&pdf (Accessed Nov. 2012).

Hatt, B. E., Fletcher, T. D., and Deletic, A. (2008). "Hydraulic and pollutant removal performance of fine media stormwater filtration systems." *Environ. Sci. Technol.*, 42(7), 2535–2541.

ISMM. (2009). "*Iowa stormwater management manual.*"

<http://www.intrans.iastate.edu/publications/documents/handbooks-manuals/stormwater/Design/2E/2E-4%20Bioretention%20Systems.pdf> (Accessed Nov.2012).

Karcher, D. E., and Richardson, M. D. (2003). "Quantifying turfgrass color using digital image analysis." *Crop Sci.*, 43(3), 943–951.

Keblin, M., Barrett, M., Malina, J., and Jr. Charbeneau, R. (1998). *The effectiveness of permanent highway runoff controls: sedimentation/filtration systems.* Rep. No. TX-00/2954-1, Center for transportation research bureau of engineering research the University of Texas at Austin, Austin, Texas.

Kocman, S. M., Guo, J. C. Y., and Ramaswami, A. (2011). "Waste-Incorporated Subbase for Porous Landscape Detention Basin Design." *J. Environ. Eng.*, 137(10), 928–936.

Low Impact Development Center, Inc. (2003). "Drainage-bioretention specification."

<http://www.lowimpactdevelopment.org/epa03/biospec.htm> (Accessed Nov. 2012).

Ming-Han, L., Chan, Y., Sung, Myung, H., Kim, and Kung-Hui, C. (2010). "*Bioretention for Stormwater Quality Improvement in Texas: Pilot Experiments.*" Texas Department of Transportation, Austin, Texas.

MPCA. (2000). *Protecting water quality in urban areas: best management practices for dealing with storm water runoff from urban, suburban, and developing areas of Minnesota.* Minnesota pollution control agency, Minneapolis.

MSG. (2011). "Mallard sand and gravel general specifications."

<http://mallardsand.com/id6.html> (Accessed Nov. 2012).

National Climatic Data Center (NCDC). (2012). "Monthly climatological summary."

<http://www1.ncdc.noaa.gov/pub/orders/96364.pdf>,

<http://www1.ncdc.noaa.gov/pub/orders/96368.pdf> (Accessed Nov. 2012).

- National Resource Conservation Service (NRCS). (1986). *Urban hydrology for small watersheds TR - 55*. <http://www.cpesec.org/reference/tr55.pdf> (Accessed Oct. 2012).
- NDEQ. (2006). *Nebraska Administrative Code*. Nebraska Dept. of Environmental Quality, Lincoln, NE.
- NDOR (2006). *Drainage and Erosion Control Manual*. Nebraska Department of Roads, Aug. 2006.
- NDOR. (2010). *Seeding Handbook for Highway Maintenance*. Nebraska Department of Roads.
- NDOR. (1997). *Supplemental Specifications Book*. NE Dept. of Roads.
- NRCS. (2011). "Soil Survey Staff, Natural Resources Conservation Service, United States Department of Agriculture. Web Soil Survey." <http://websoilsurvey.nrcs.usda.gov/> (Accessed Nov. 2012).
- Olsson Associates. (2006). *Omaha Regional Stormwater Manual*. Omaha, Nebraska.
- A. Patton, Walker, K., McDuffee, D., Bigelow, C., Latin, R. and Reicher, Z. (2005). "Using Digital Image Analysis to Quantify Turfgrass Cover and Disease." <http://www.agry.purdue.edu/turf/report/2005/11.pdf> (Accessed Nov. 2012).
- PGCM. (2007). *Bioretention Manual: Environmental Services Division Department of Environmental Resources the Prince George's County, Maryland*. Prince George county department of environmental resources.
- PSBMP. (2006). *Pennsylvania Stormwater Best Management Practices Manual*. <http://www.starkenvironmental.com/downloads/PADEP.pdf> (Accessed Nov. 2012).
- Stansbury, J., Moussavi, M., and Zhang, T. (2012). *Feasibility of integrating natural and constructed wetlands in roadway drainage system design*. NDOR Rep. No. SPR-1(09)P325. NE Dept. of Roads, Lincoln, NE.
- Stapleton, J. (2008). "Soil stabilization for gardens and landscapes." <http://www.ipm.ucdavis.edu/PDF/PESTNOTES/pnsoilsolarization.pdf> (Accessed Nov. 2012).
- Thompson, A. M., Paul, A. C., and Balster, N. J. (2008). "Physical and hydraulic properties of engineered soil media for bioretention basins." *Transactions of the Asabe*, 51(2), 499–514.

TNLA. (2006). *TNLA Green Magazine*. Texas Nursery and Landscape Association, May, 2006.

U.S. EPA. (1999). *Preliminary Data Summary of Urban Storm Water Best Management Practices*. Rep. No. EPA 821-R-99-012, U.S. Environmental Protection Agency, Office of Water, Washington D.C.

USDA. (2008). "Soil quality indicators."
http://soils.usda.gov/sqi/assessment/files/available_water_capacity_sq_physical_indicator_sheet.pdf (Accessed Nov. 2012).

USEPA. (1996). *Managing urban runoff*. Rep. No. EPA 841-F-96-004G, U.S. Environmental Protection Agency, Washington, D.C.

Vacha, B. (2012). *Feasibility of integrating natural and constructed wetlands in roadway drainage system design volume II*. M.S. Thesis. Civil Eng. Dept., University of Nebraska-Lincoln, May 2012.

Willis, W., and Power, J. (2012) "Soil temperature and plant growth in the northern great plains." <http://images.library.wisc.edu/EcoNatRes/EFacs/NAPC/NAPC04/reference/econatres.napc04.wwillis.pdf> . (Accessed Oct. 2012).

WRA Environmental Consultants, I. (2009). *Appendix B: Soils, plantings, and irrigation for bioretention facilities in stormwater C.3 Guidebook* . Contra Costa Clean Water Program.

Appendix A Design Information on the Four BMP Sites with a Design Example

Table A.1 shows design information on the four BMP sites. To illustrate how to come up with Table A.1, a design example of filter trench is described below.

Site information. The aerial photo in Figure A.1 shows the total watershed that contributes to the filter trench at the Slat Valley site location in Lincoln, NE. The total impervious area is considered to be new or redeveloped, and runoff from this area needs to be treated. The total area of the watershed is 4.84 acres with 1.4 acres impervious, 2.61 acres grass, and 0.83 acres gravel. The impervious area contributes to the run off or WQV, and the gravel and grass area contributes to run on volume and flows.

Calculating runoff and run on volumes. Runoff volumes are calculated with a design precipitation of 0.75 inches which corresponds to 0.5 inches of runoff from impervious areas. Each sub-basin is calculated separately based on land use using equation 2-2. The curve numbers used are 98 for impervious, 84 for grass, and 86 for gravel based on hydraulic soil group B from Table 2.1 and curve numbers from Table 2.2. The runoff depth from each sub basin is 0.55 inches, 0.06 inches, and 0.09 inches for impervious area, grass and gravel, respectively. Multiplying the depth by the area of the sub-basin we find that impervious area, grass and gravel contribute 2,808 ft³, 567 ft³ and 263 ft³ of runoff, respectively. With these numbers the total WQV is 3,639 ft³ with the impervious area contributing 2,808 ft³ and the run on area contributing 830 ft³.

Calculating peak 10-year flow-rates. Runoff flow-rates are calculated using the rational method with a 10-year return period with a storm duration equal to the time of

concentration. The peak flow-rates are calculated for each sub-basin then added together. The rational method coefficients used in this example are 0.95 for impervious areas, 0.35 for grass areas, and 0.45 for gravel areas. The time of concentration was found using equation 2-5 for the most hydraulically remote sub-basin and is 6.5 minutes. From Figure 2.4 the rainfall intensity to be used in the rational method equation is 8 in/hr based on the time of concentration of 6.5 minutes. From equation 2-4 the peak flows for each sub basin are 10.68 cfs, 7.31cfs, and 2.97 cfs from the impervious, grass and gravel areas, respectively. The total flow-rate for the watershed is 20.96 cfs.

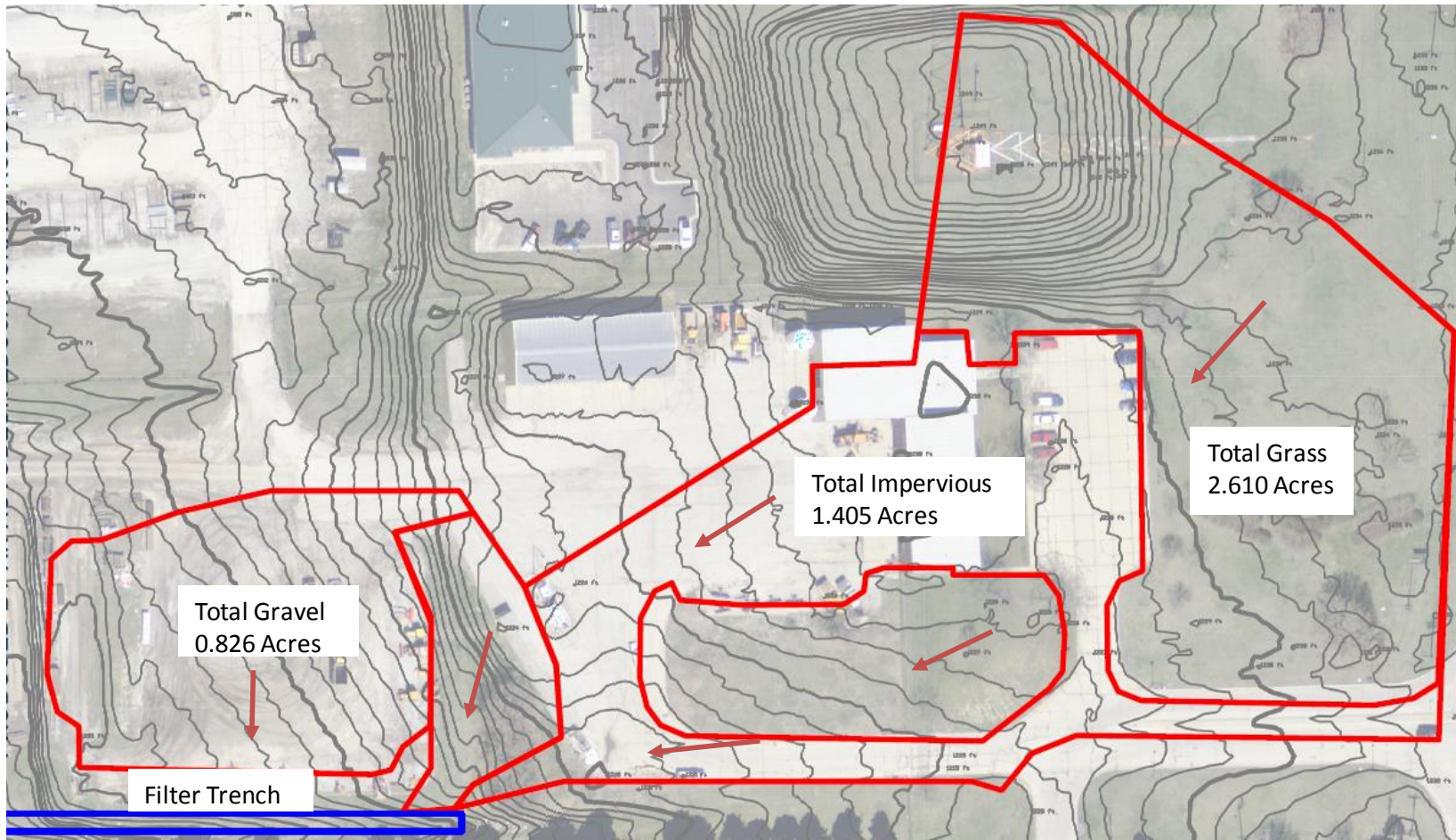

Figure A.1 Filter trench example watershed

Table A.1 BMP areas, WQV, and 10-year flows

BMP site/type	land type areas (Acres)				WQV (ft ³)				10-year flow-rates (cfs)			
	impervious	grass	gravel	total	impervious	grass	gravel	total	impervious	grass	gravel	total
I street/check dam filters	0.48	1.93	0.00	2.40	952.31	35.56	0.00	987.87	4.07	6.07	0.00	10.15
Salt Valley/Infiltration Trench	2.65	2.82	0.44	5.91	5290.64	613.60	140.07	6044.30	17.60	6.91	1.38	25.90
Salt Valley/Filter Trench	1.41	2.61	0.83	4.84	2808.94	567.50	263.09	3639.53	10.68	7.31	2.97	20.96
Salt Valley/ Bioretention	2.65	2.82	0.44	5.91	5290.64	613.60	140.07	6044.30	17.60	6.91	1.38	25.90

Appendix B Field Photos and Vegetative Monitoring



Figure B.1 Bioretention after construction



Figure B.2 Check dam filters before construction



Figure B.3 Check dam filters after construction with sediment deposition



Figure B.4 Infiltration trench before construction



Figure B.5 Infiltration trench after construction



Figure B.6 Filter trench before construction



Figure B.7 Filter trench after construction



Figure B.8 Bioretention diversion during construction



Figure B.9 Bioretention diversion after construction



Figure B.10 Small disturbed area by infiltration trench



Figure B.11 Sediment bucket in infiltration trench



Figure B.12 Rain event during construction of filter trench



Figure B.13 Filter trench outlet during rain event



Figure B.14 Control check vegetation picture from a lawn in Papillion, NE



Figure B.15 7/11/2012 sand compost bioretention image 7 percent green



Figure B.16 8/9/2012 sand compost bioretention image 44 percent green



Figure B.17 8/22/2012 sand compost bioretention image 32 percent green



Figure B.17 9/26/2012 sand compost bioretention image 63 percent green

Appendix C QA/QC

Chemical oxygen demand (COD) analysis. COD was tested for the last 3 weeks of reactor loadings. Samples were preserved with 2% (v/v) sulfuric acid (Fisher A300-212) and analyzed per APHA 5220 D methods, colorimetric method. The digestion vials used were 0-15,000ppm range CAT. 2415915. The spectrophotometer used was a Genesys 10uv from thermo scientific set to a 600nm. The correlation coefficient for the standard curve used for COD testing was 0.9977 (Fig. C.1).

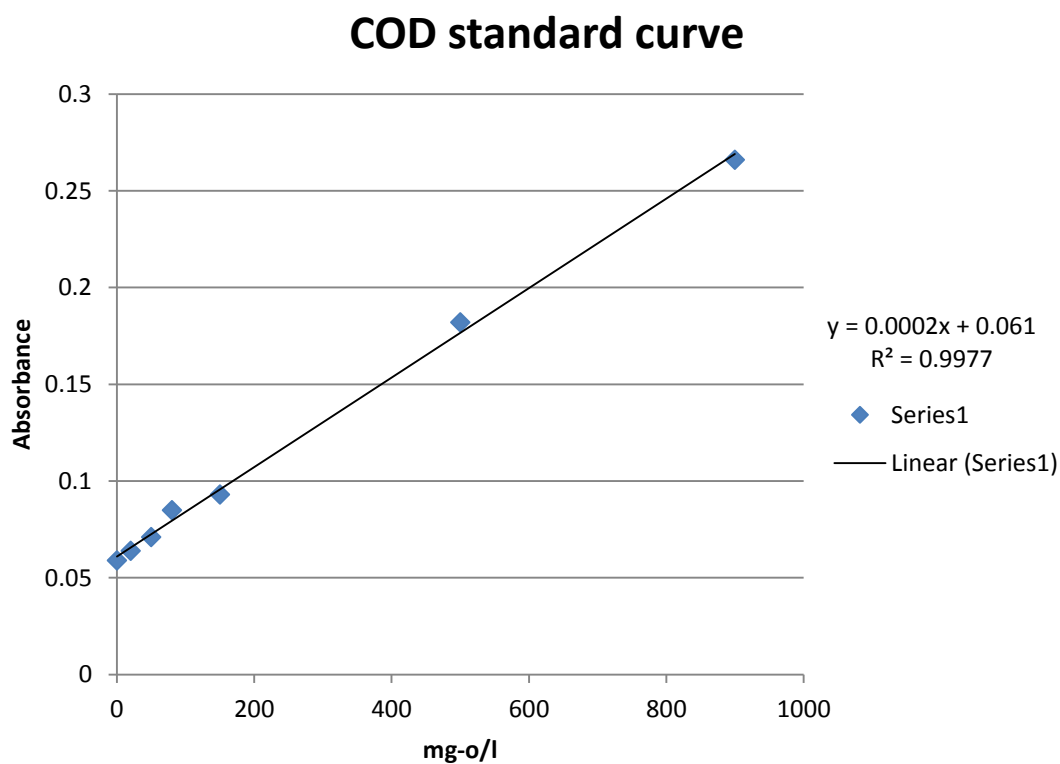

Figure C.1 COD standard curve

Nitrate analysis. This test follows section 4110 B of Standard Methods. Nitrate was analyzed using ion chromatograph instrument model 792 Basic IC Metrohm with an anion IC column (P/N: ANX-99-8511) and a flow rate set to 1.35 mL/min. Before measuring, samples were filtered through a 0.45- μm syringe filter. A solution of 1.8 mM sodium carbonate and 1.7 mM sodium bicarbonate was used as the eluent. The computer software is the same brand and model that came with the instrument. The ion chromatograph was calibrated once by a trained professional with a standard curve correlation coefficient of 0.99999. Check standards with known concentrations were run before each round of analysis was tested.

TSS analysis. This test follows Section 2540 D of Standard Methods. A continuously stirred sample was filtered through a weighed standard glass-fiber 0.50 μm filter (catalog and maker's info) and the residue retained on the filter is dried to a constant weight at 103–105°C for 1 h. The increase in weight of the filter represents the TSS.

Metals analysis. This test follows 3125 B of Standard Methods. Samples were preserved with 2% (v/v) trace metal grade nitric acid (Fisher A509-212) after collection. Samples were analyzed with an Inductively Coupled Plasma Mass Spectrometry (ICP-MS) (2004 Varian). Samples were preserved with nitric acid but not digested or filtered. Total metals are considered the concentration of metals determined from an unfiltered vigorously digested sample. Dissolved metals are considered metals from an unacidified sample filtered through a 0.45 μm filter (APHA et al. 2012). Our samples were preserved and unfiltered because of the analysis and preservation method and are most closely

related to the definition of total metals. All dilutions and standards used were made with de-ionized water and 2 percent trace metal grade nitric acid. A four point standard curve was used with concentrations of 0, 10, 50, and 200 ppb. All standard curves were acceptable if a correlation coefficient ≥ 0.9999 was observed. After initialization of standards the standards were run as samples to verify correctness of standards and the instrument. A continuing standard was run after every 10 sample runs and was the 50 ppb standard solution which remained within 10 percent with a goal of 5 percent. A continuous internal standard (Rhodium) was used to track instrument drift and sample viscosity. The ICP-MS was run in peak hopping mood with 5 replicates, 16 scans and a dwell time of 10 ms, and the machine flow rate was set to 0.33 ml/min.

Method detection limit. The calculation of the method detection limit was done using excel calculation of the standard curve data. Table C.2 is an example for nickel using the ICP-MS. Four points were used on the standard curve 0, 10, 50, 200 ppb with the related counts per second used by the ICP-MS. The columns from left to right are (1) ppb concentration, (2) counts per second, (3) x values, (4) y values, (5) x values squared, (6) y values squared, (7) x values multiplied by the y values, (8) the calculated y values using the best fit equation, and finally (9) the last column is the residual of each standard point which is the difference in the actual y and the calculated y.

The calculation of the S.D. Residuals, S_y is the standards of deviation of the y residual of each standard point, taking into account the degrees of freedom or n-1. The detection limit is then calculated by 3 times the S.D. Residuals, S_y . The equation of best fit and Correlation Coefficient, R is also reported in this table, which were $y = 5299.24x$

+7437.53 with $R = 0.99991$. The result of the t test for this example is also reported and was 4.30. In addition, the result of the “g” statistic is shown which was 0.0016 and a good value is below 0.005. The method detection limit for nickel for this example is 3.373 $\mu\text{g/L}$.

Table C.2 Calculation of the method detection limit of Nickel and statistics

	Raw Data		Transformed Data						
	(1) <i>x</i>	(2) <i>y</i>	(3) <i>f(x)</i>	(4) <i>f(y)</i>	(5) <i>f(x)²</i>	(6) <i>f(y)²</i>	(7) <i>f(x) · f(y)</i>	(8) <i>f'(y)</i>	(9) Residuals
Identity	ppb	Instrument Signal							
Units	ppb	c/s	ppb	c/s					
First 0?	0.000	1358.800049	0	1359	0	1846338	0	7438	-6079
Expandable	10.000	59545	10	59545	100	3545607025	595450	60430	-885
	50.000	281625.4063	50	281625	2500	79312869445	14081270	272400	9226
Last	200.000	1065023.25	200	1065023	40000	1134274523041	213004650	1067285	-2262
Totals			260	1407552	42600	1217134845849	227681370		
<p>Count, $n = 4$</p> <p>$\bar{x} = 65.000$ ppb</p> <p>$\bar{y} = 351888.11$ c/s</p> <p>$S_{xx} = 25700.000$</p> <p>$S_{yy} = 721833866540.4$</p> <p>$S_{xy} = 136190460.65$</p> <p>Slope, $m = 5299.24$ c/s / c/s</p> <p>Intercept, $b = 7437.53$ c/s</p> <p>S.D. Residuals, $S_y = 7999.024$</p> <p>S.D. Slope, $S_m = 49.897$</p> <p>S.D. Intercept, $S_b = 5149.265$</p> <p>Correlation Coefficient, $R = 0.99991$</p> <p>$t(95\%, n - 2 \text{ d.f.}) = 4.30$</p> <p>"g" Statistic, $g = 0.0016$</p> <div style="border: 1px solid black; padding: 5px; width: fit-content; margin-left: auto; margin-right: auto;"> <p>Detection Limit = Blank + 3.373</p> <p>3*S_{y(resid)}=</p> </div>									

Appendix D Lab Reactor Graphs

SLR Fe Concentration

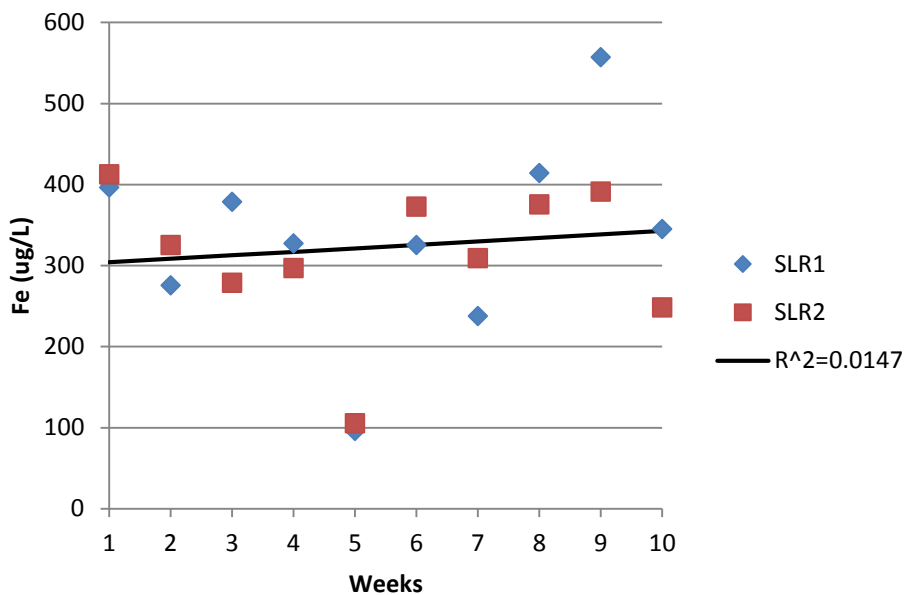

SLR Fe % Eff

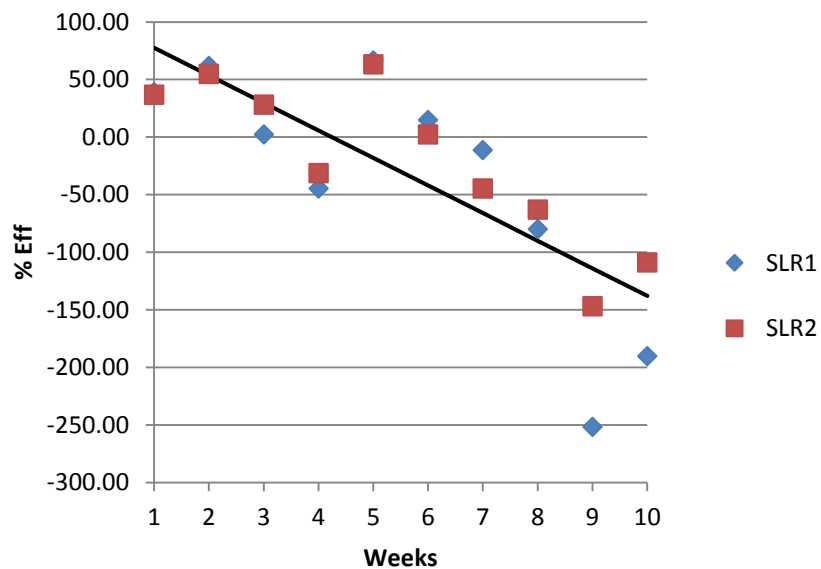

SR Fe Concentration

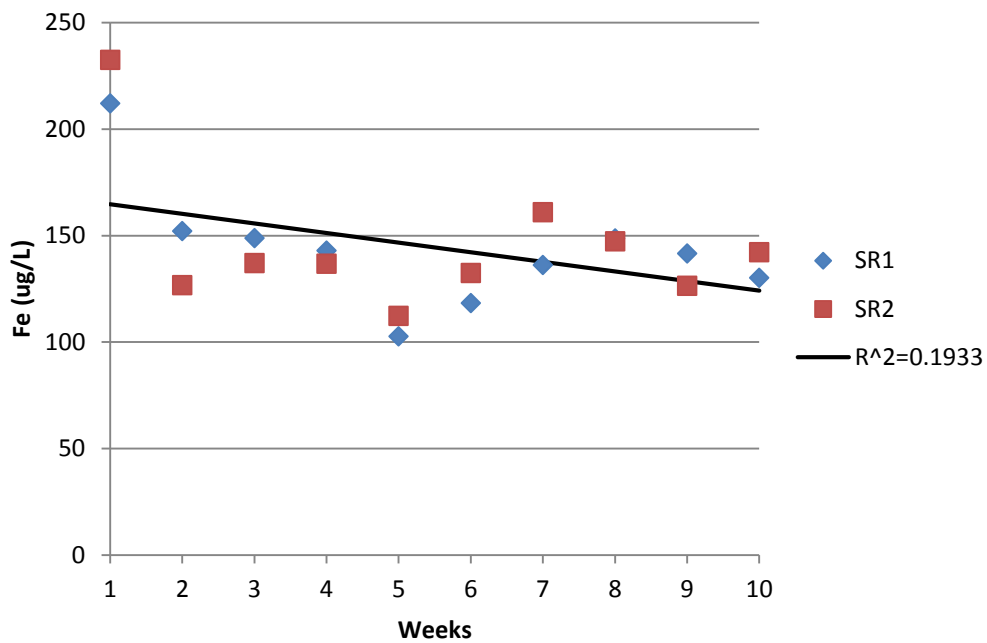

SR Fe % Eff

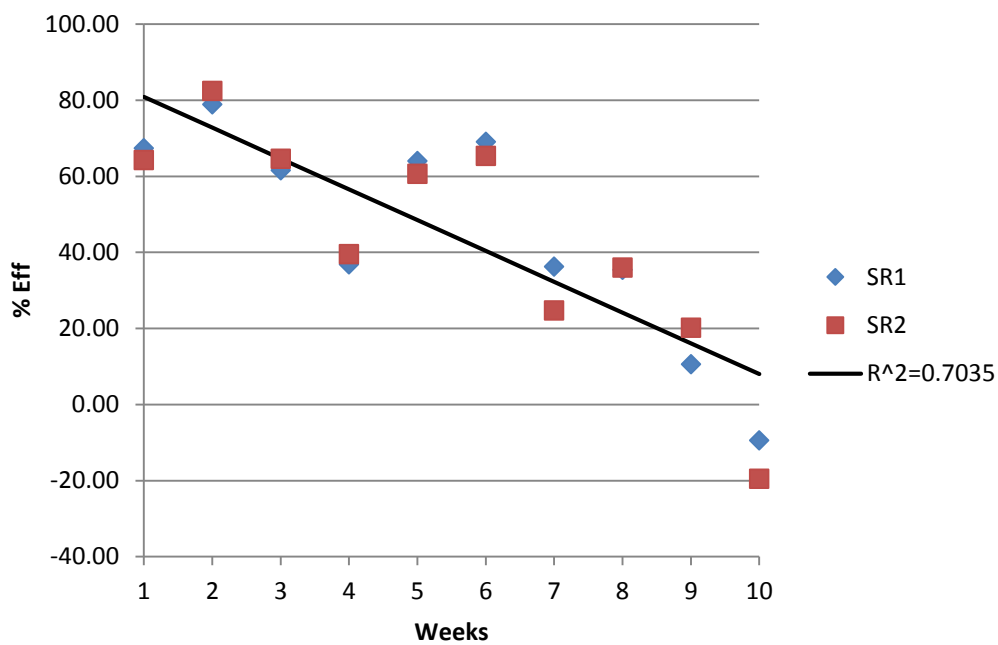

CR Fe Concentration

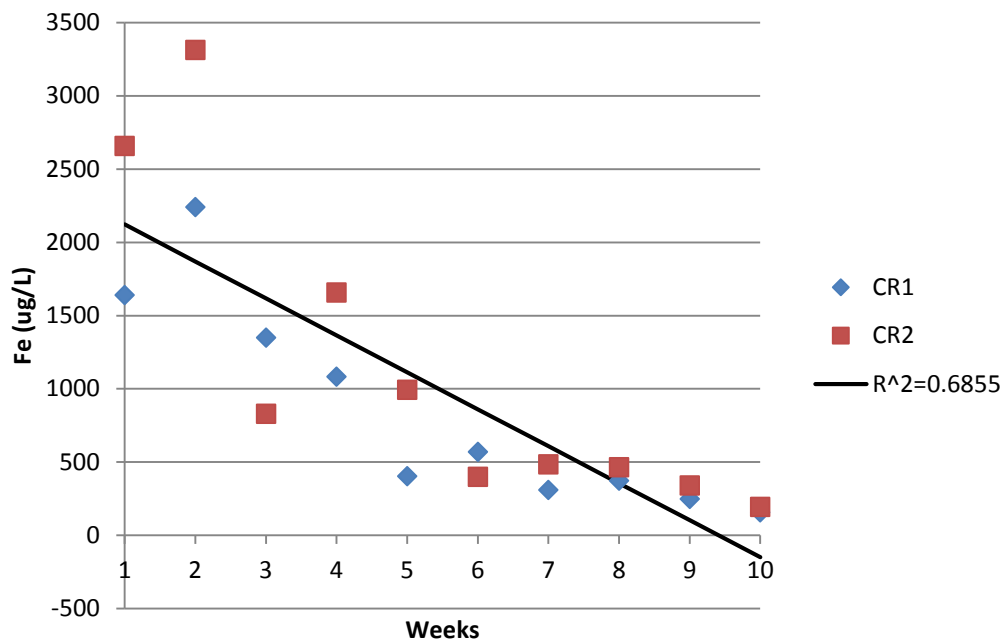

CR Fe % Eff

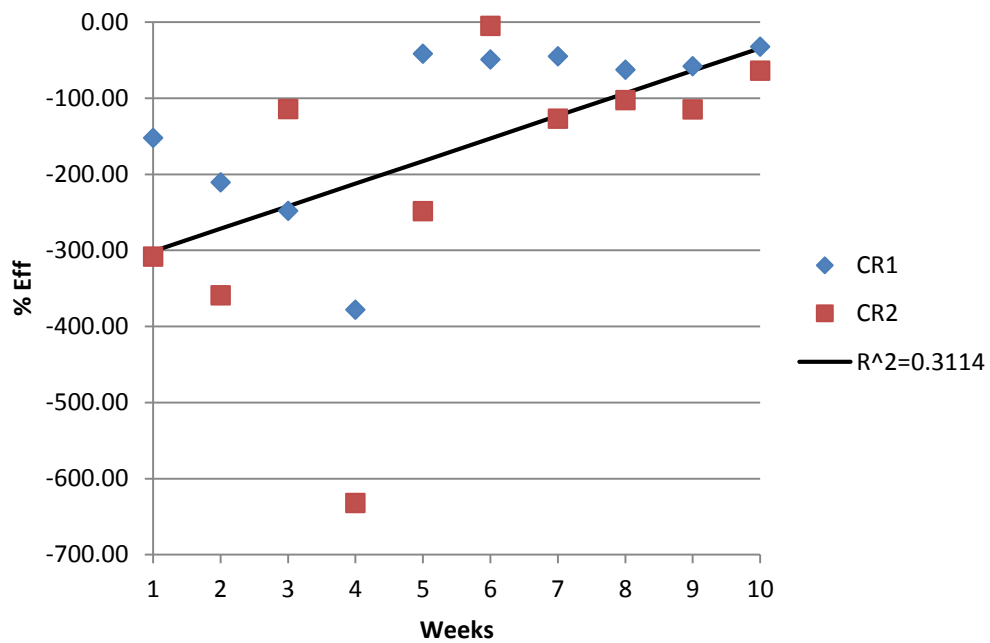

R Fe Concentration

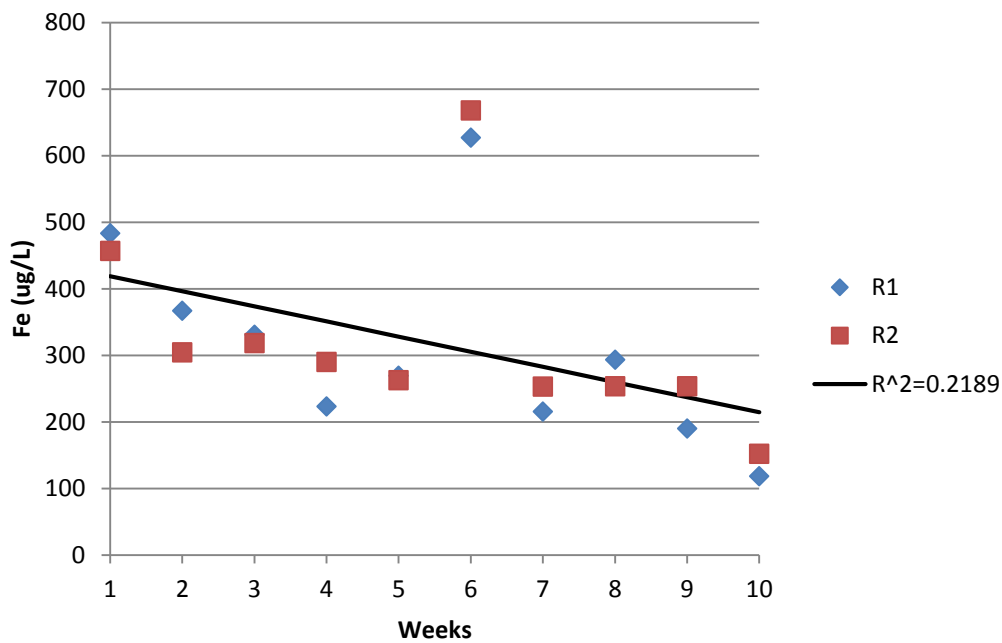

R Fe % Eff

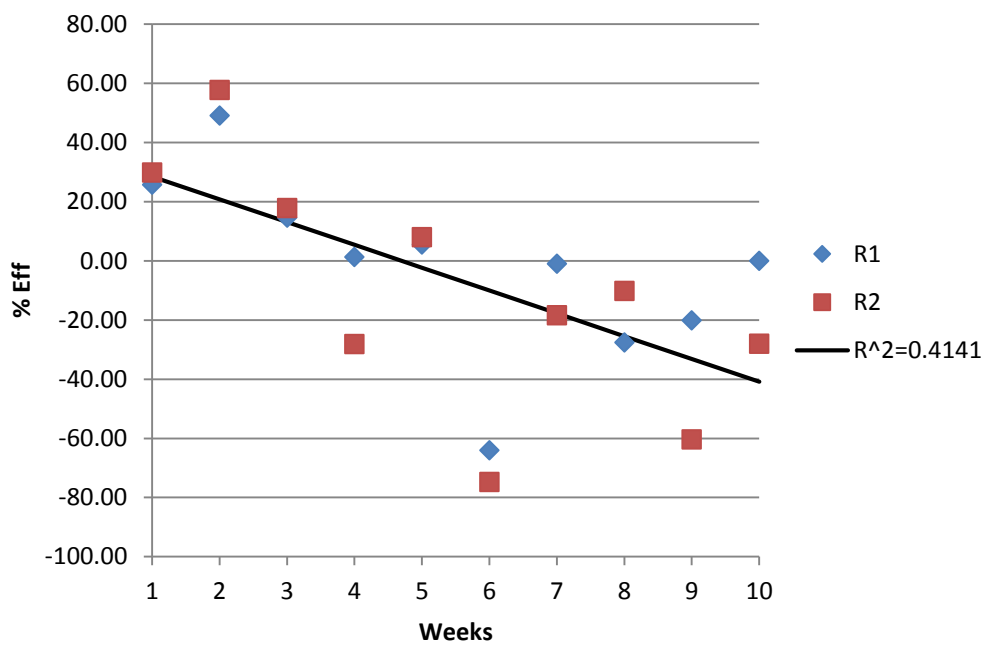

IN Fe Conc

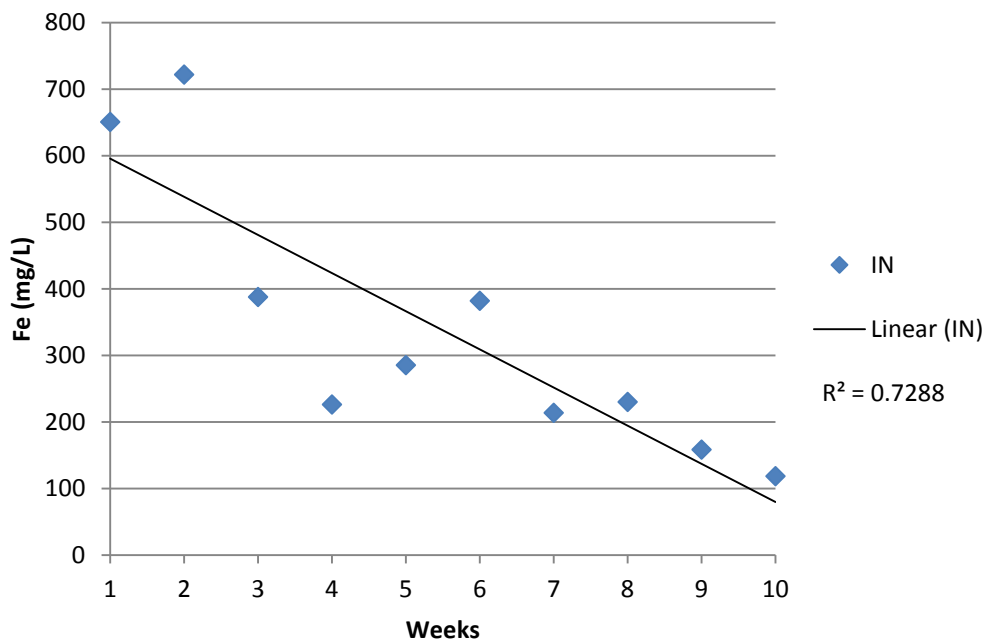

SLR Ni Concentration

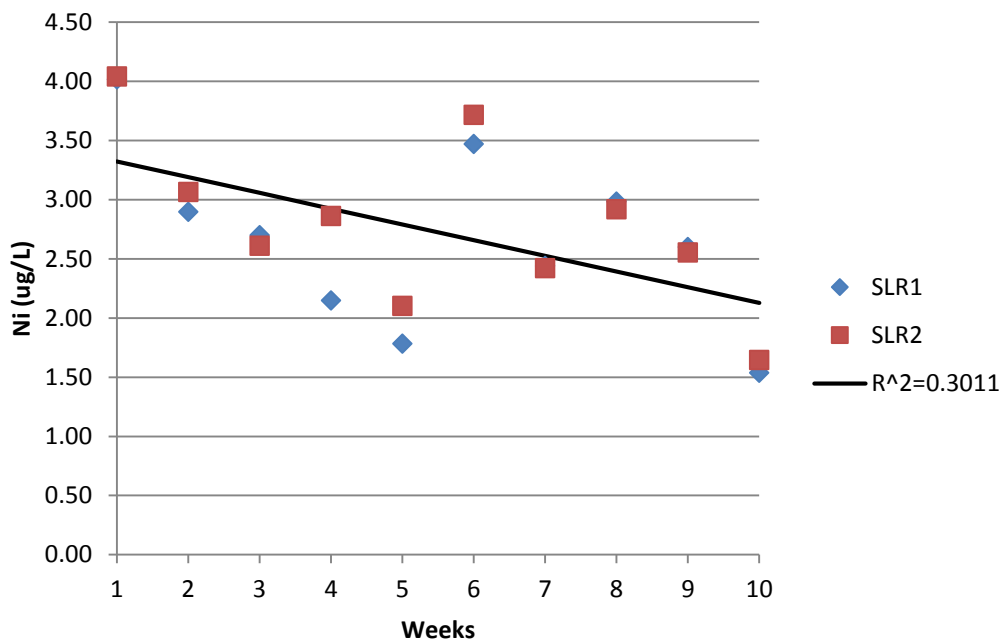

SLR Ni % Eff

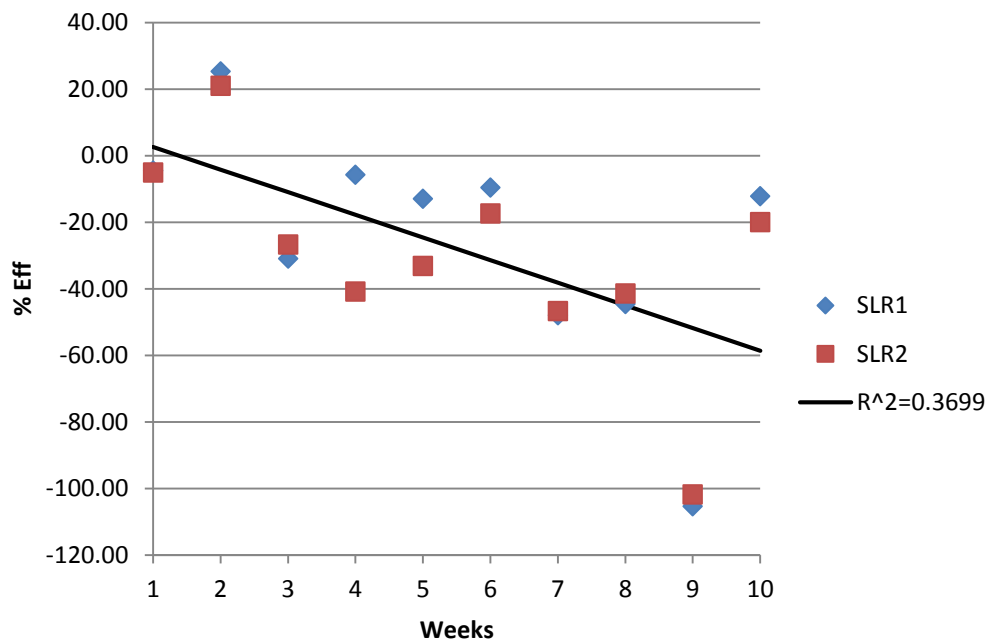

SR Ni Concentration

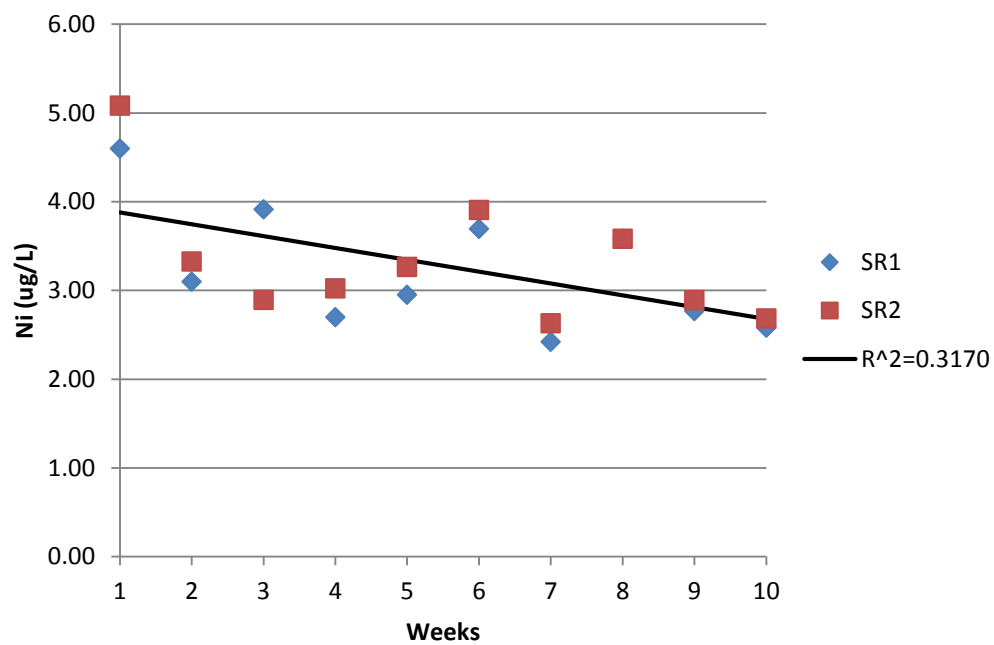

SR Ni % Eff

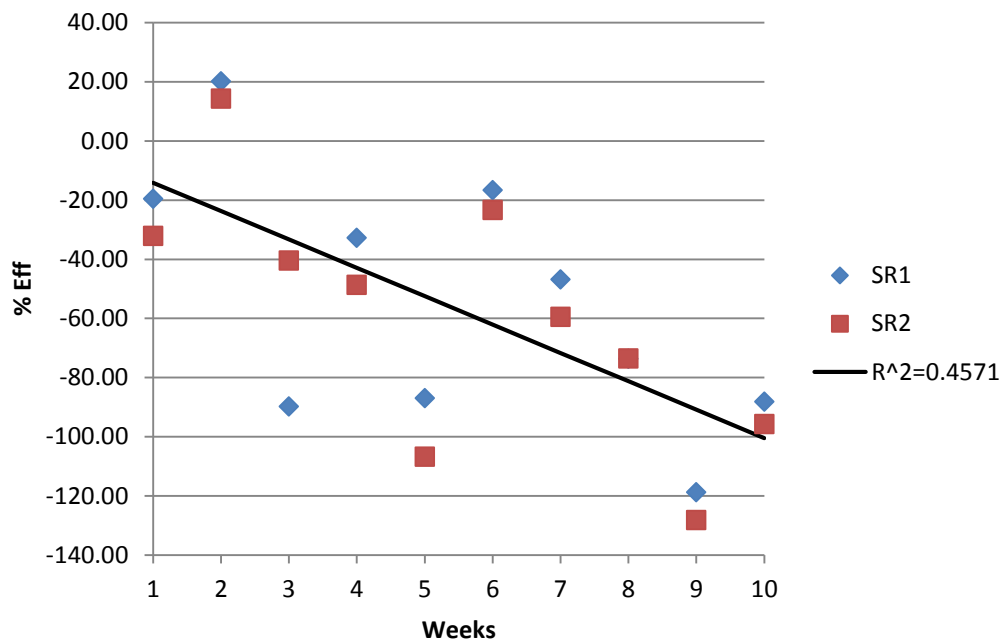

CR Ni Concentration

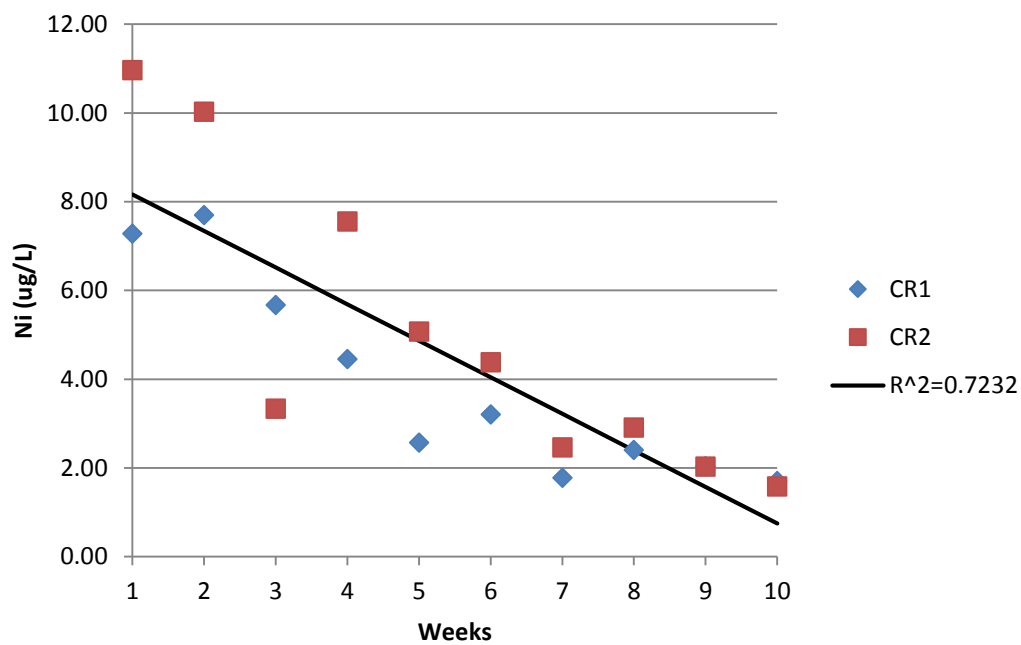

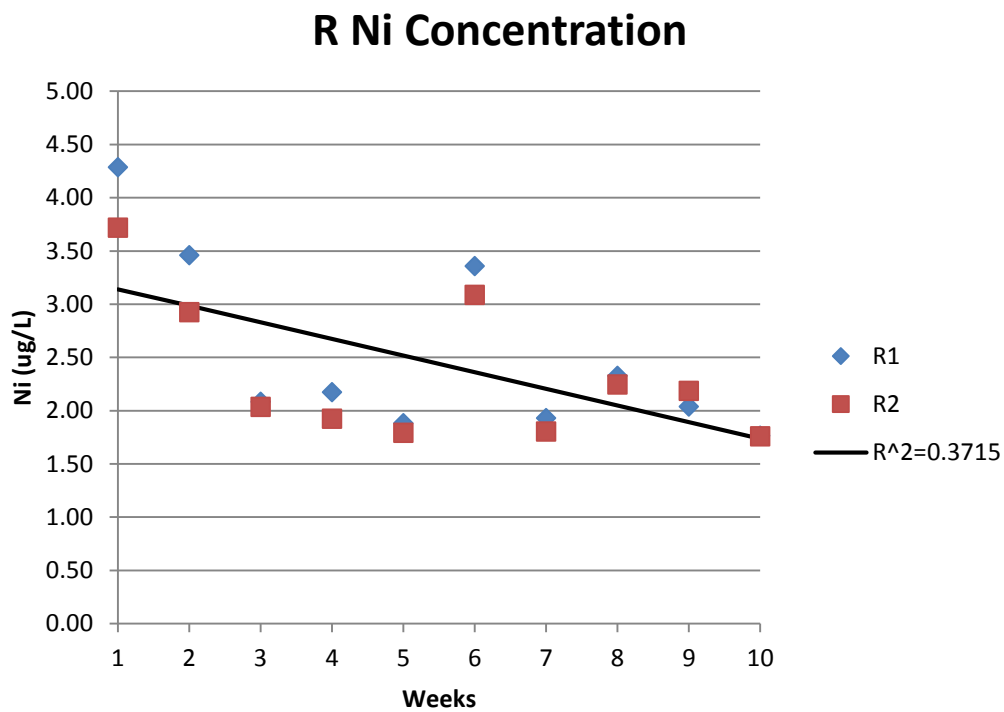
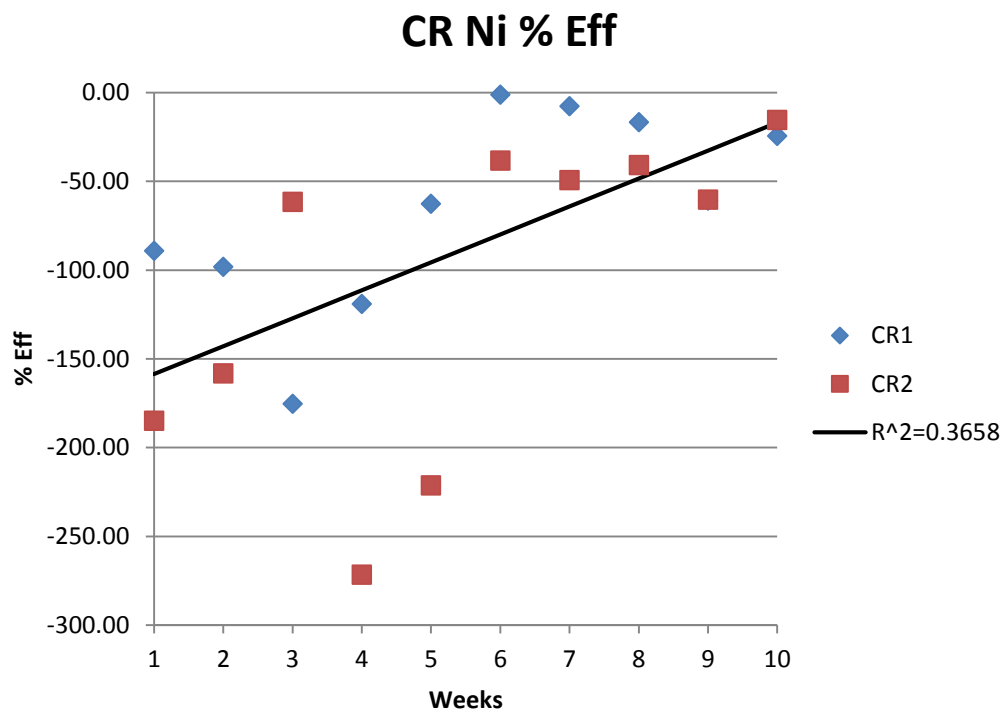

R Ni % Eff

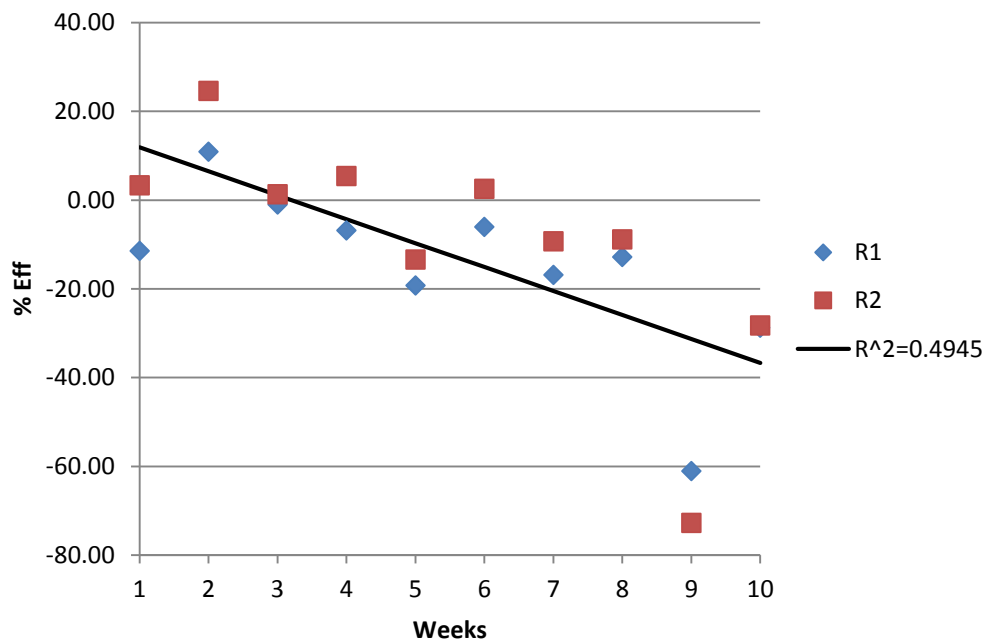

IN Ni Conc

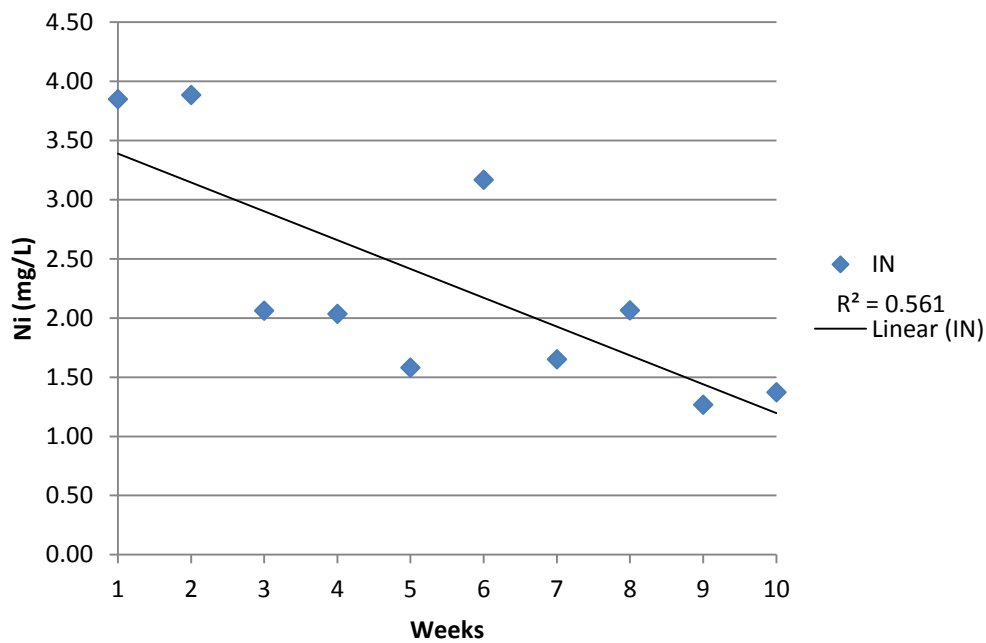

SLR Cu Concentration

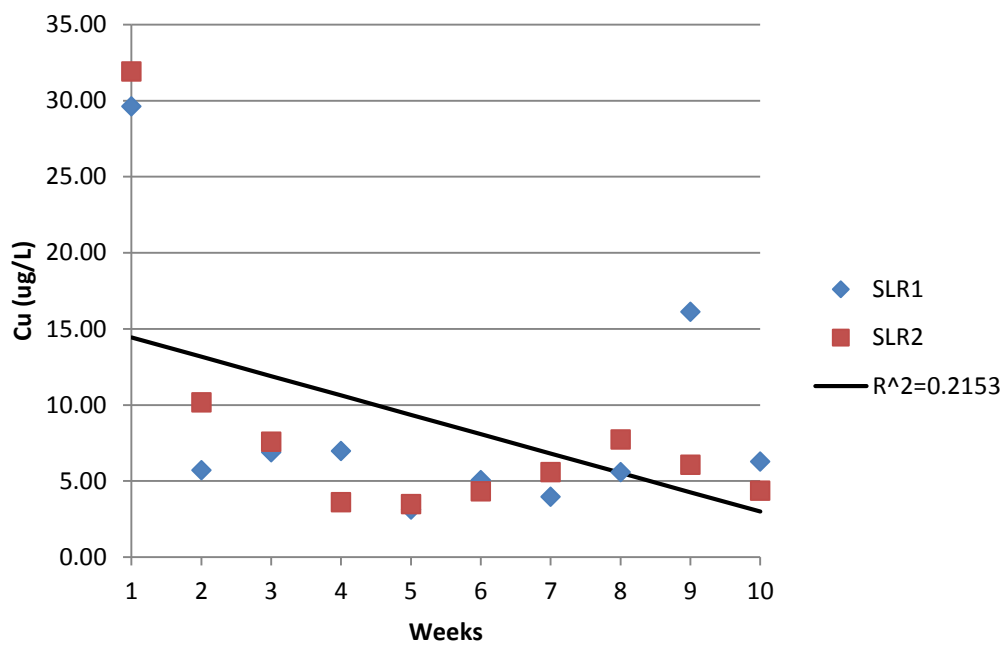

SLR Cu % Eff

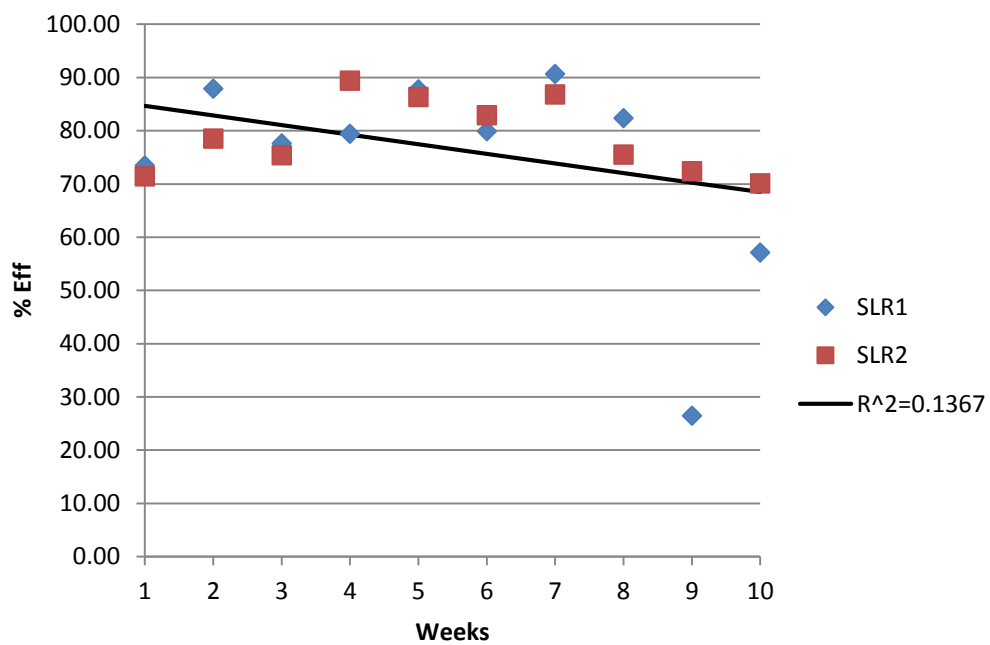

SR Cu Concentration

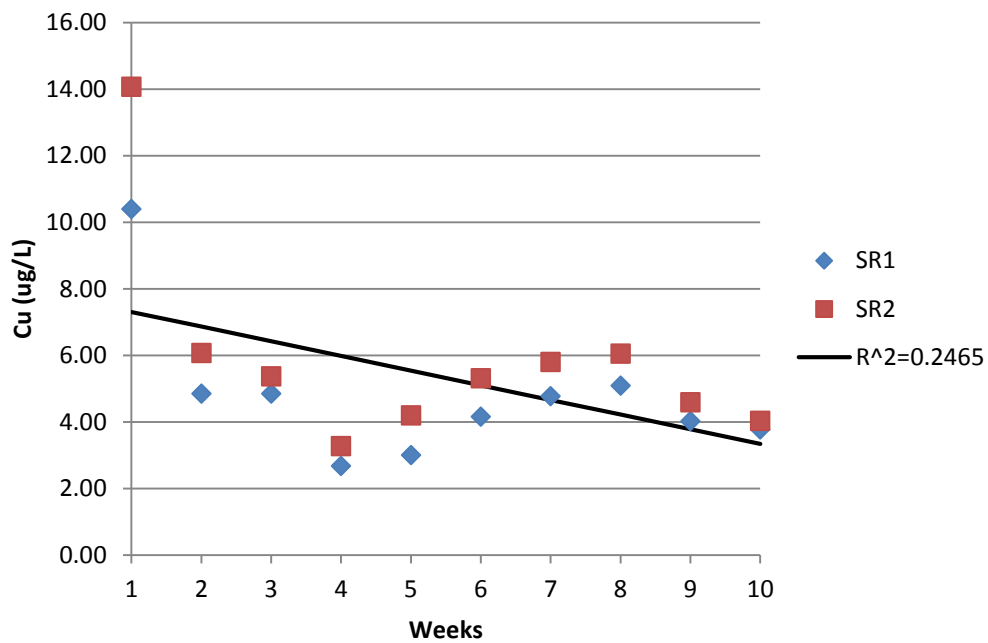

SR Cu % Eff

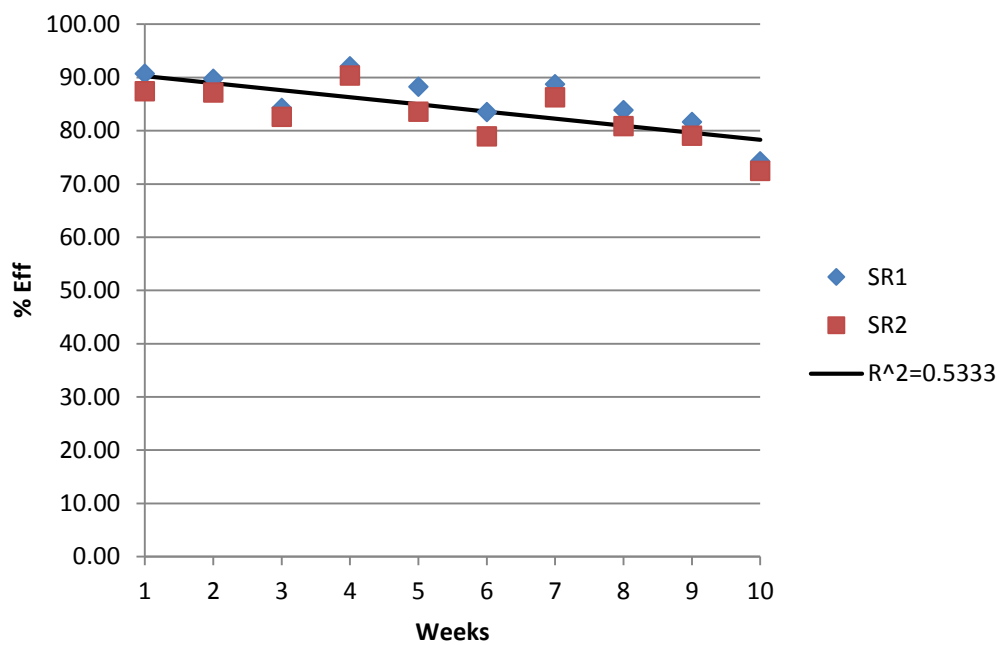

CR Cu Concentration

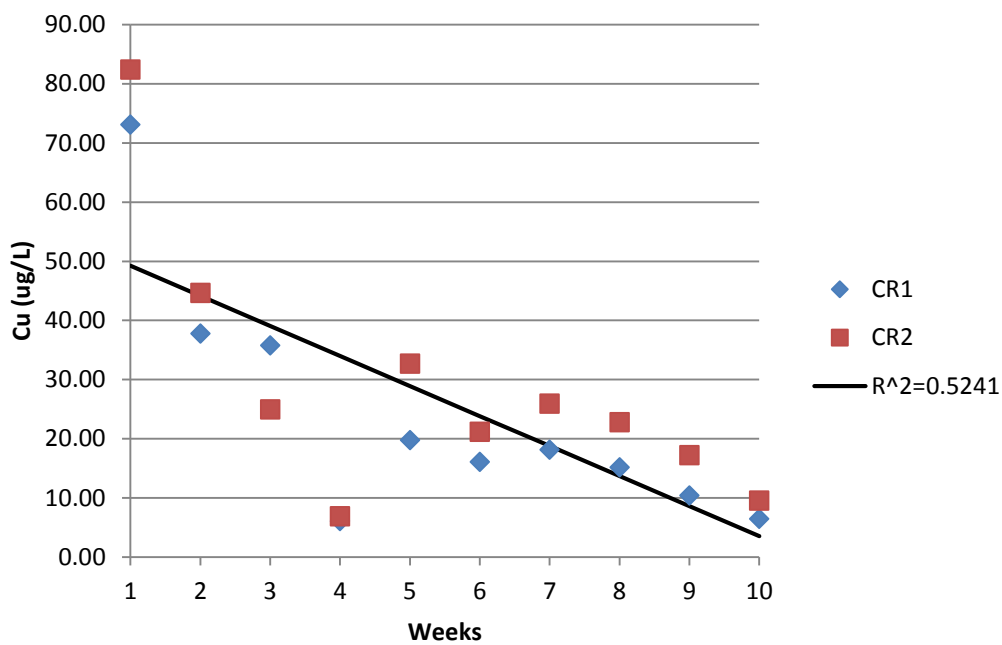

CR Cu % Eff

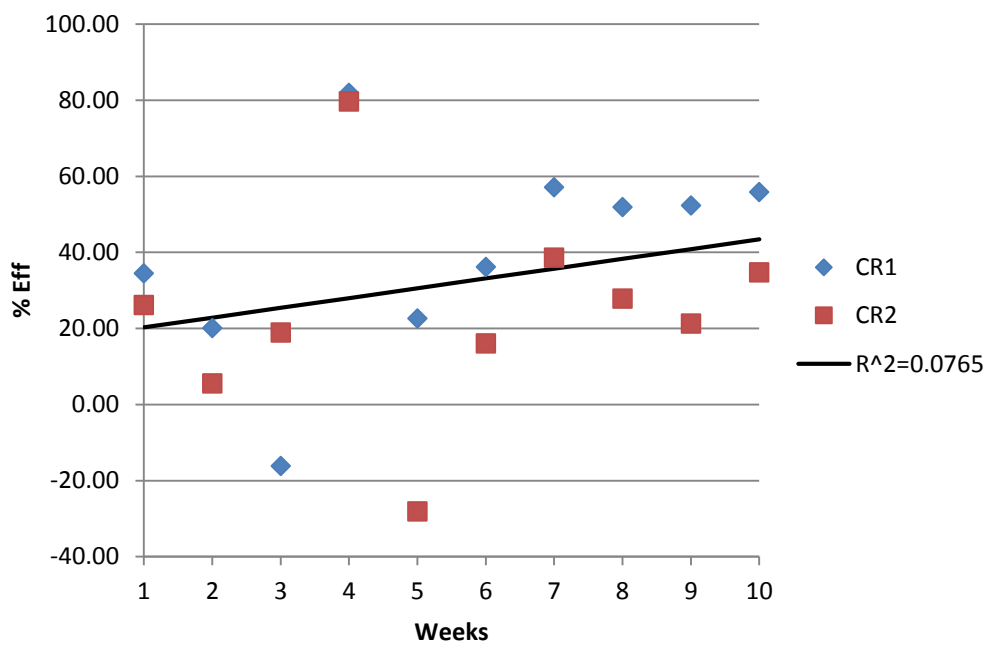

R Cu Concentration

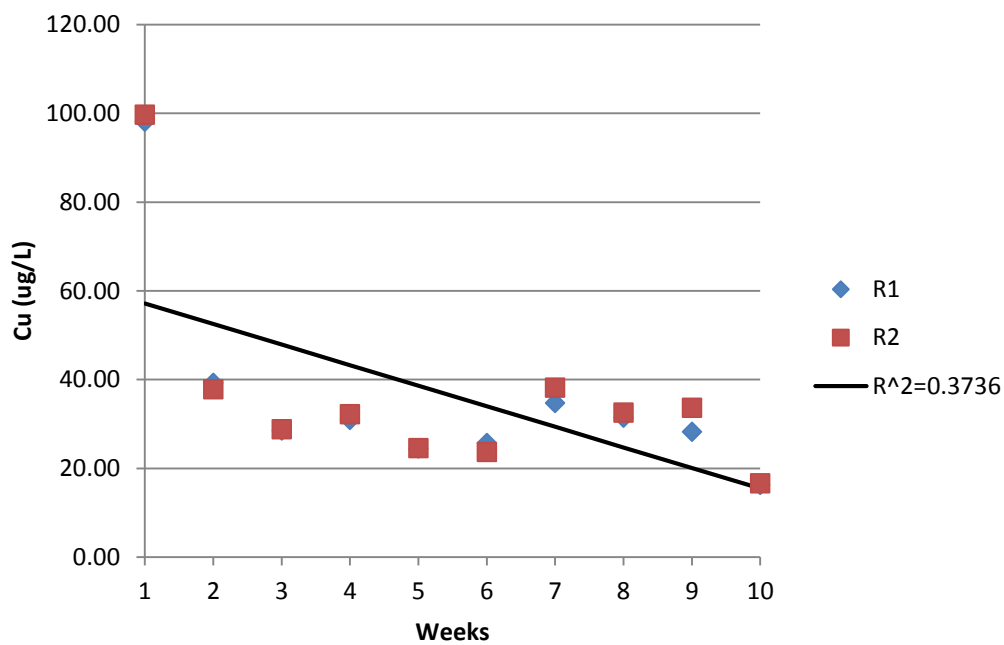

R Cu % Eff

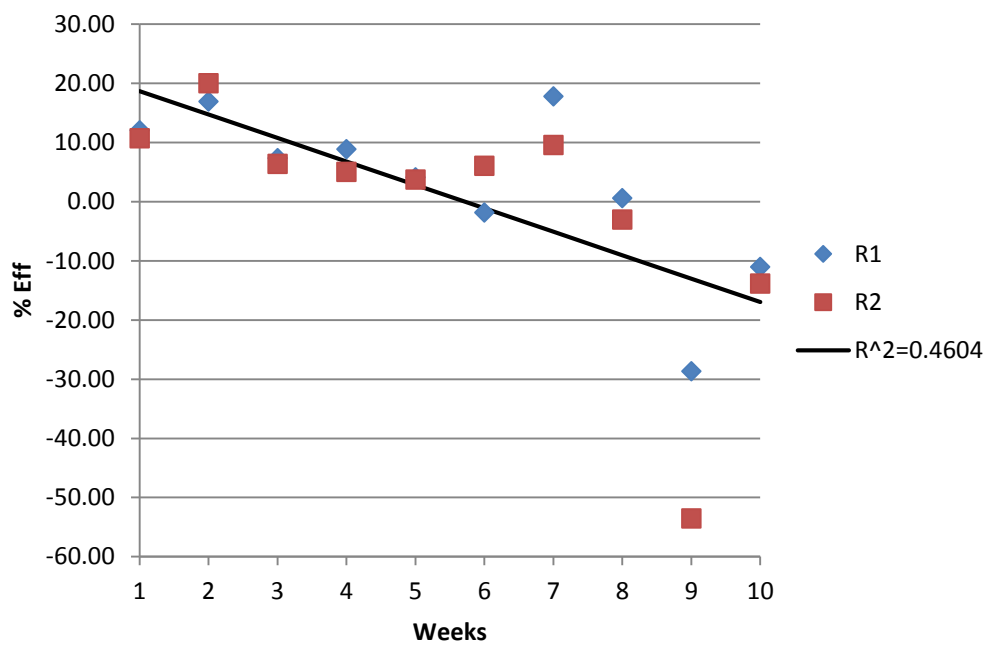

IN Cu Conc

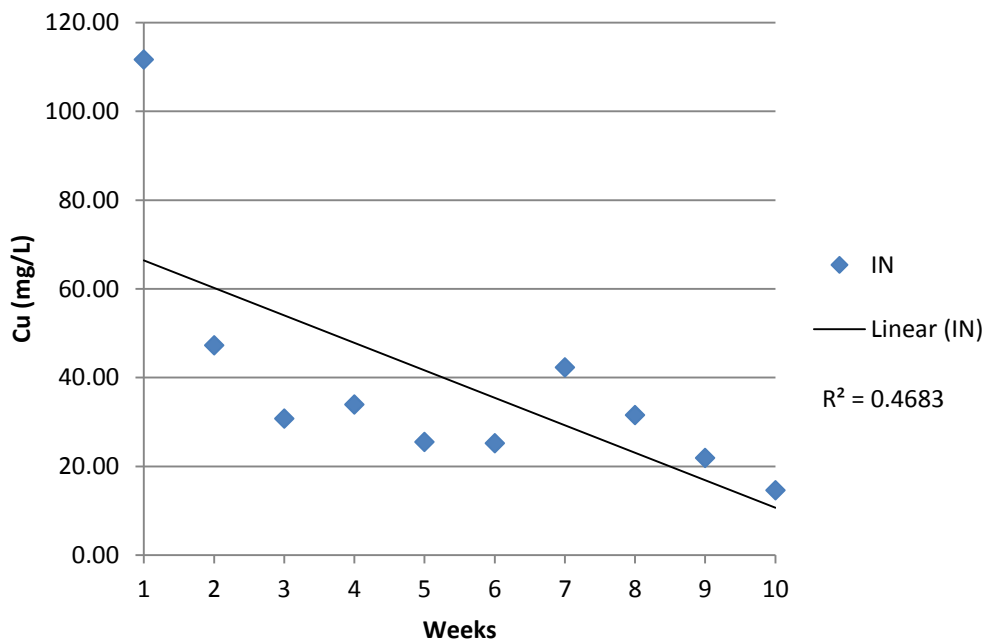

SLR Zn Concentration

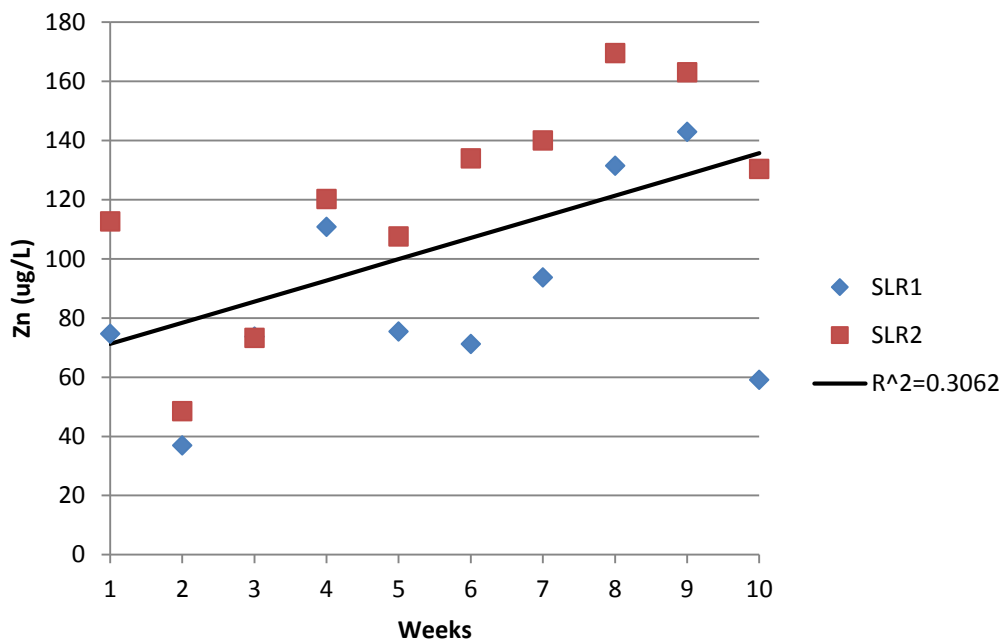

SLR Zn % Eff

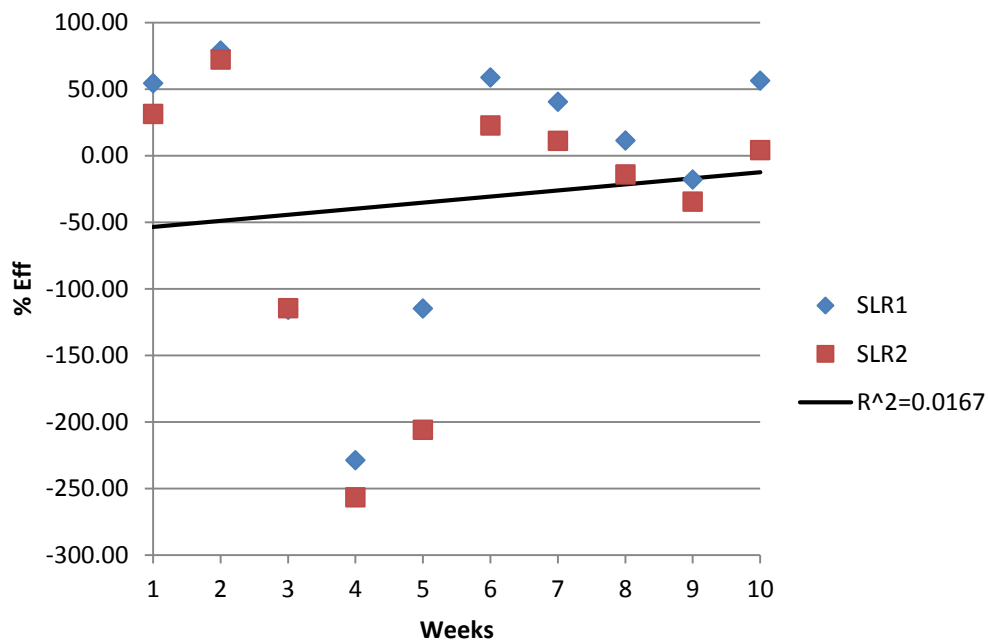

SR Zn Concentration

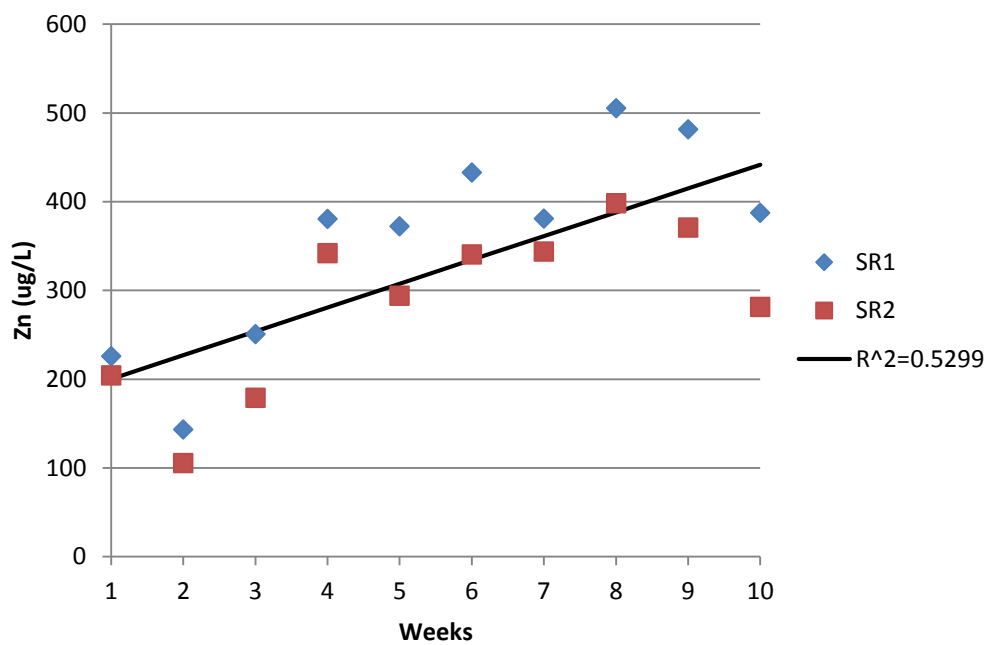

SR Zn % Eff

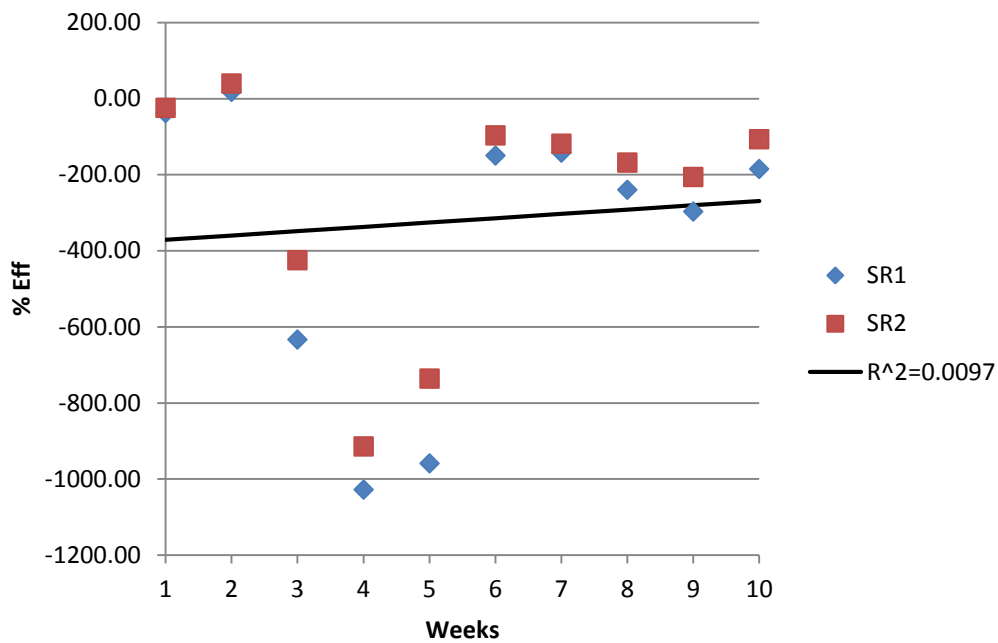

CR Zn Concentration

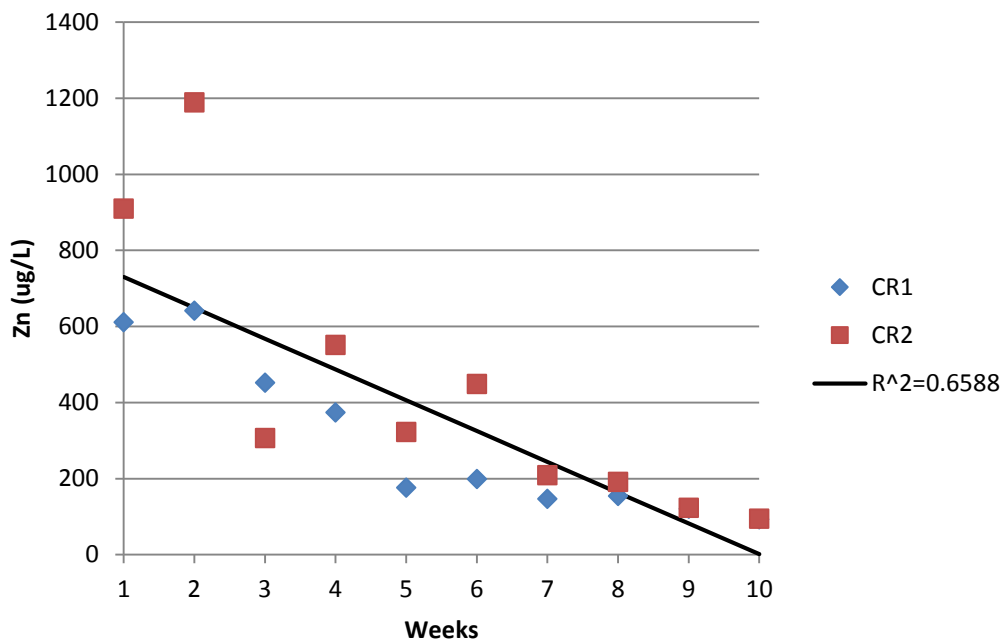

CR Zn % Eff

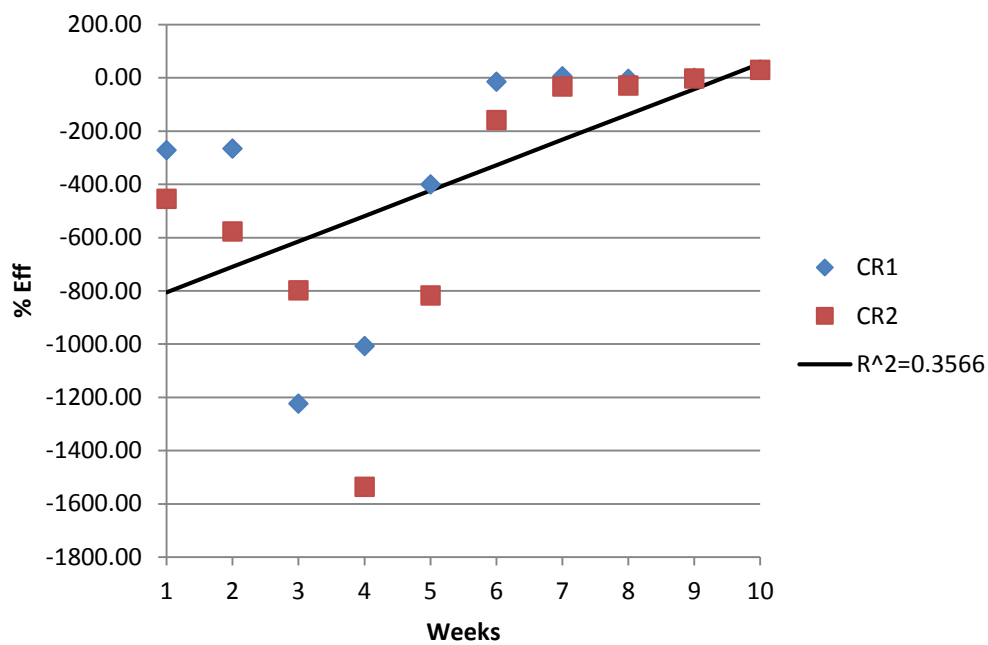

R Zn Concentration

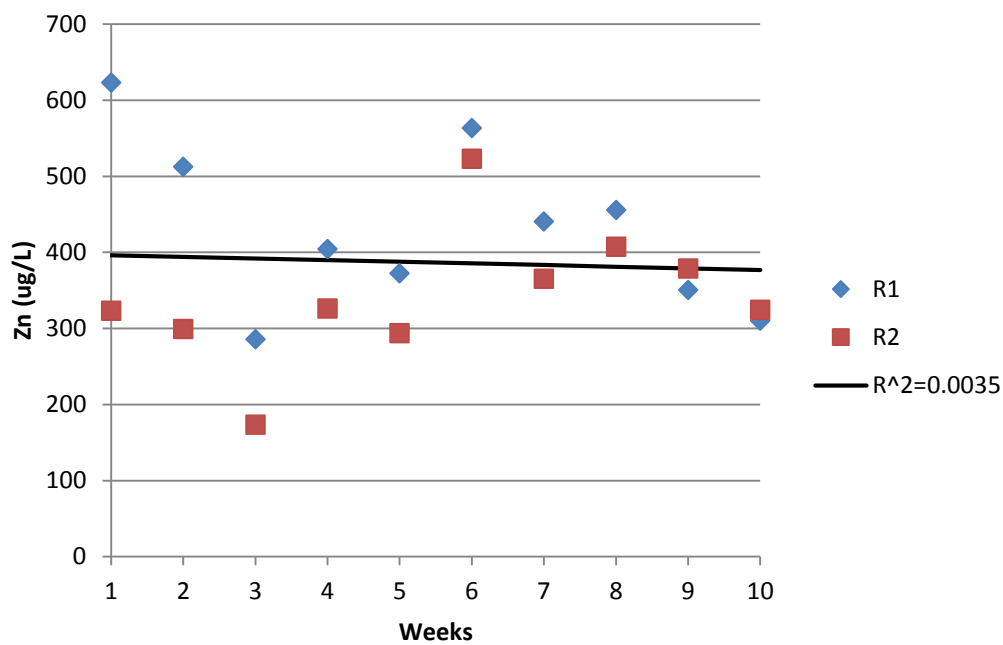

R Zn % Eff

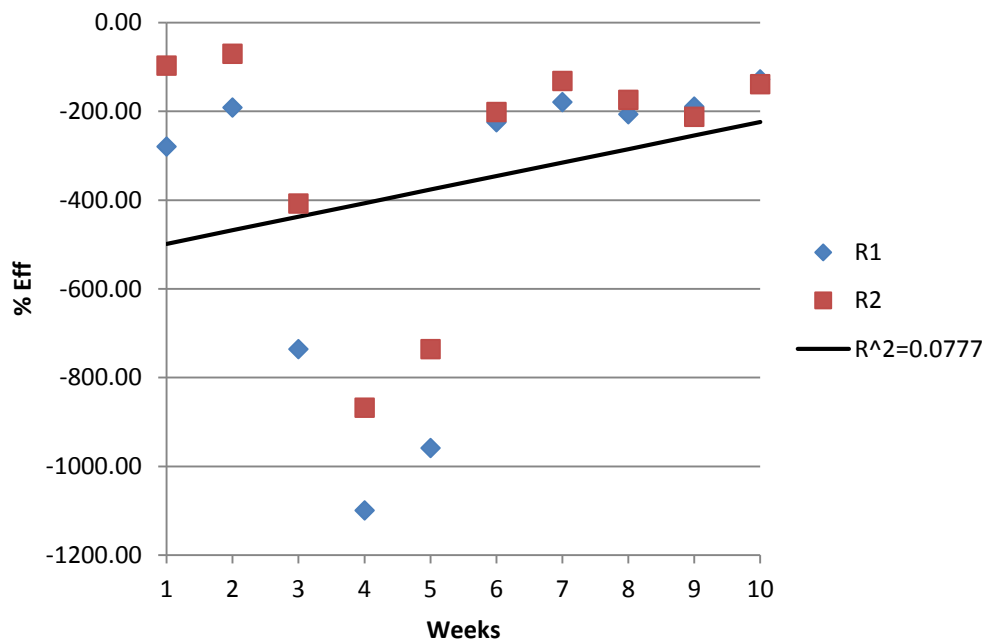

IN Zn Conc

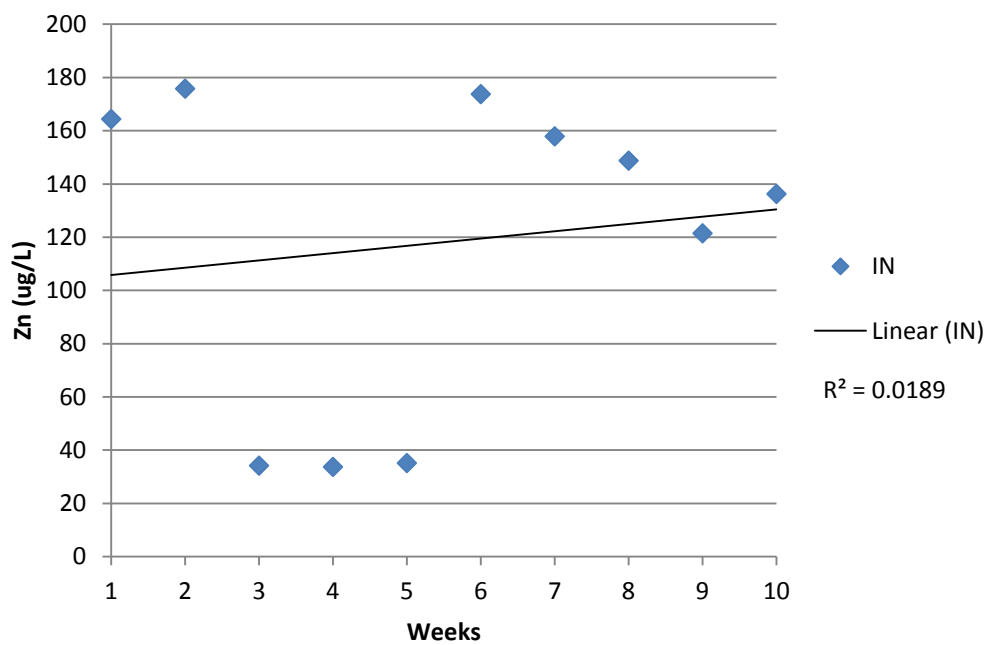

SLR Pb Concentration

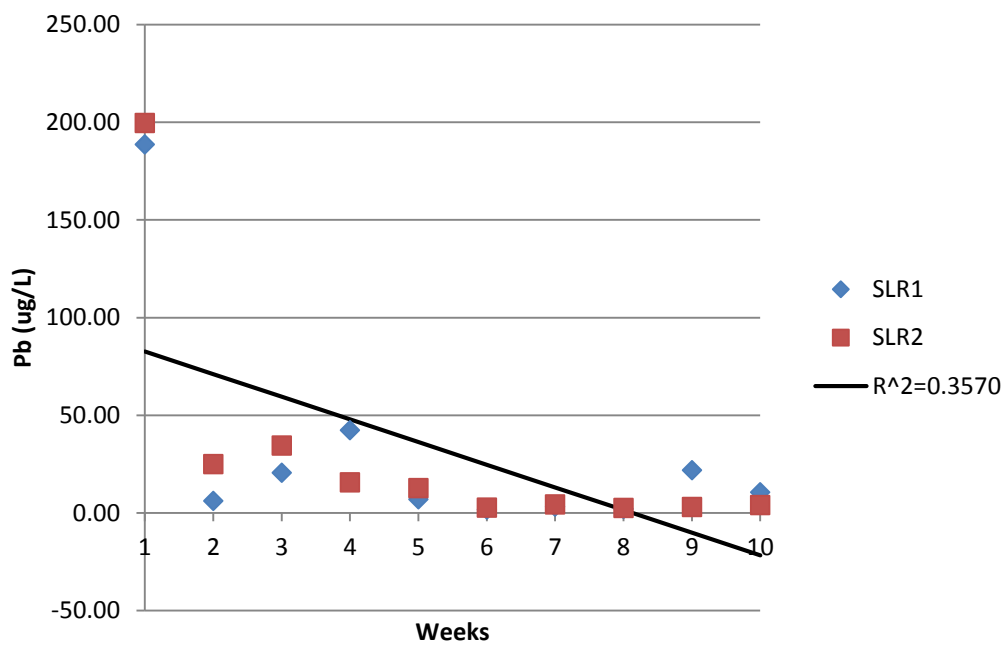

SLR Pb % Eff

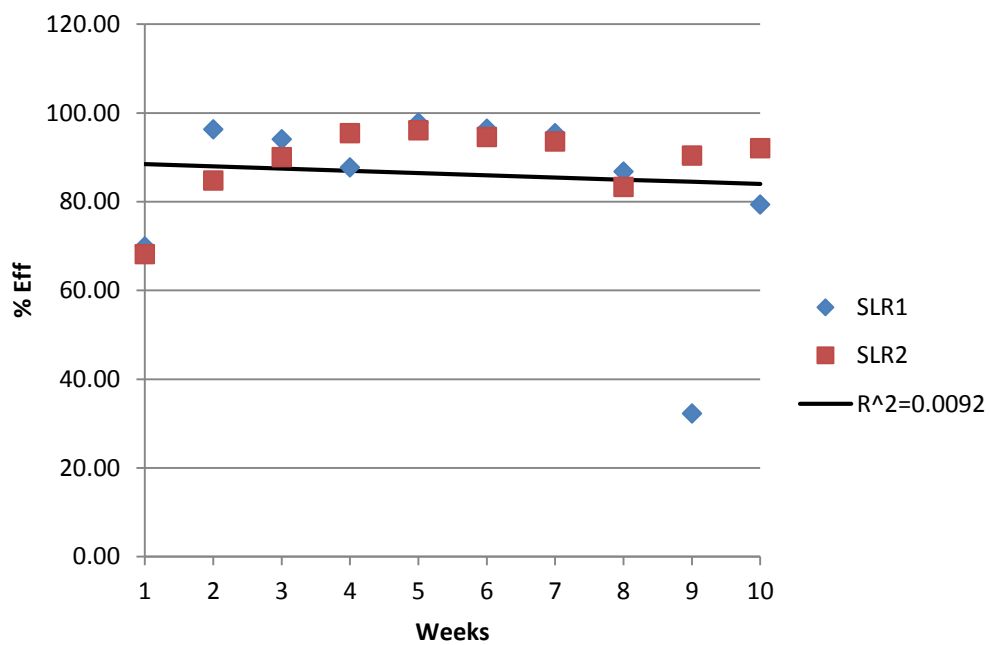

SR Pb Concentration

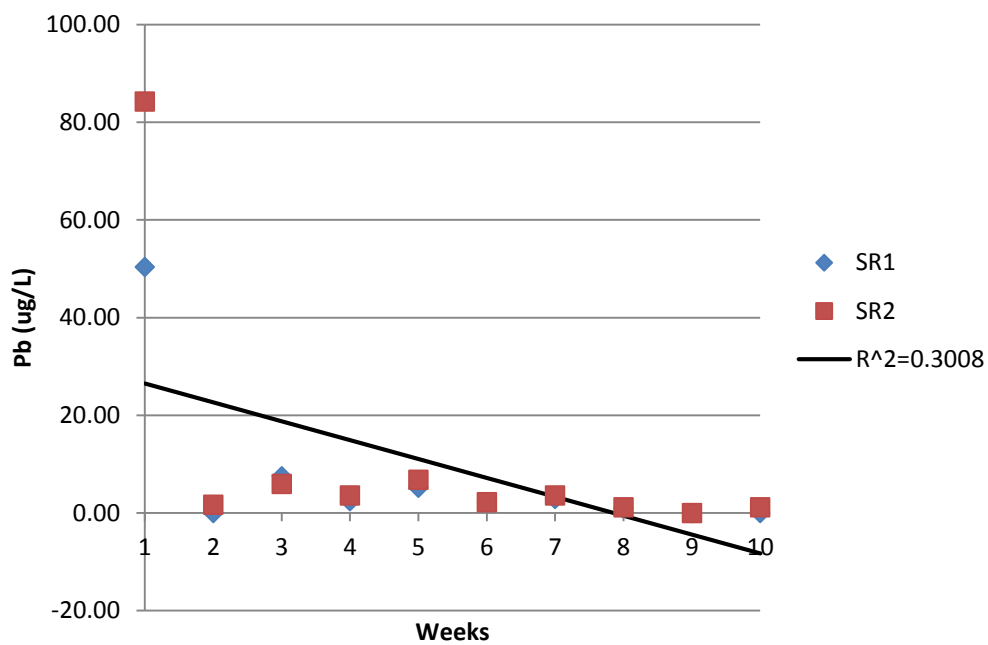

SR Pb % Eff

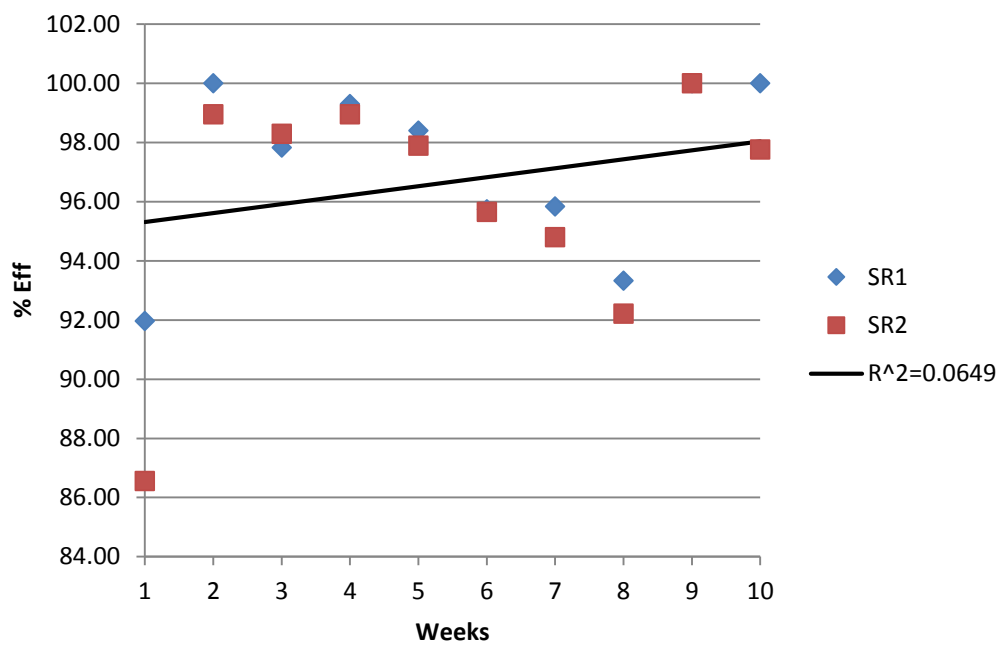

CR Pb Concentration

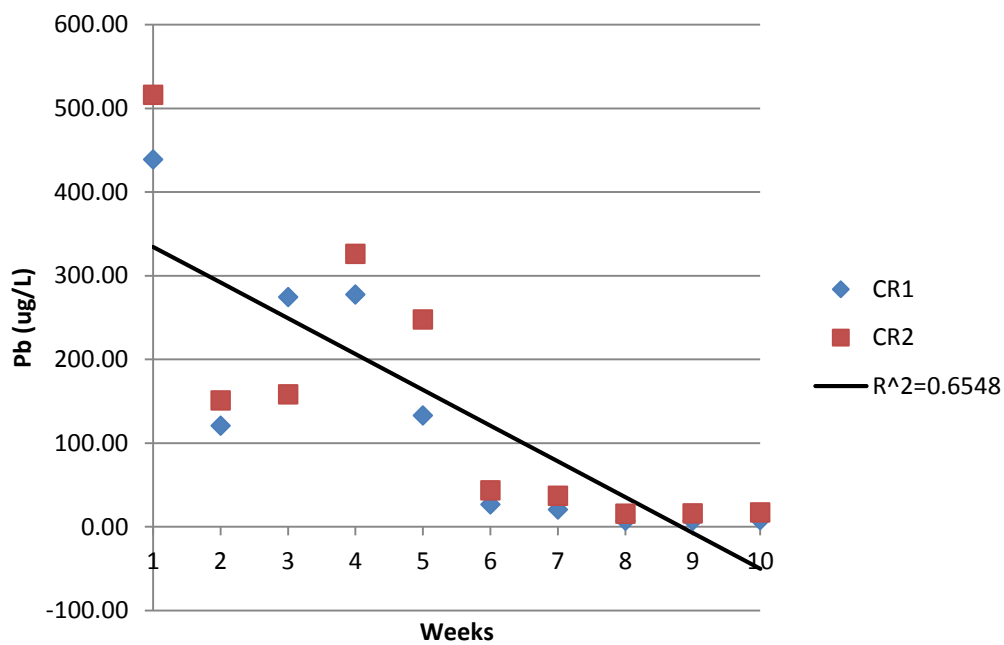

CR Pb % Eff

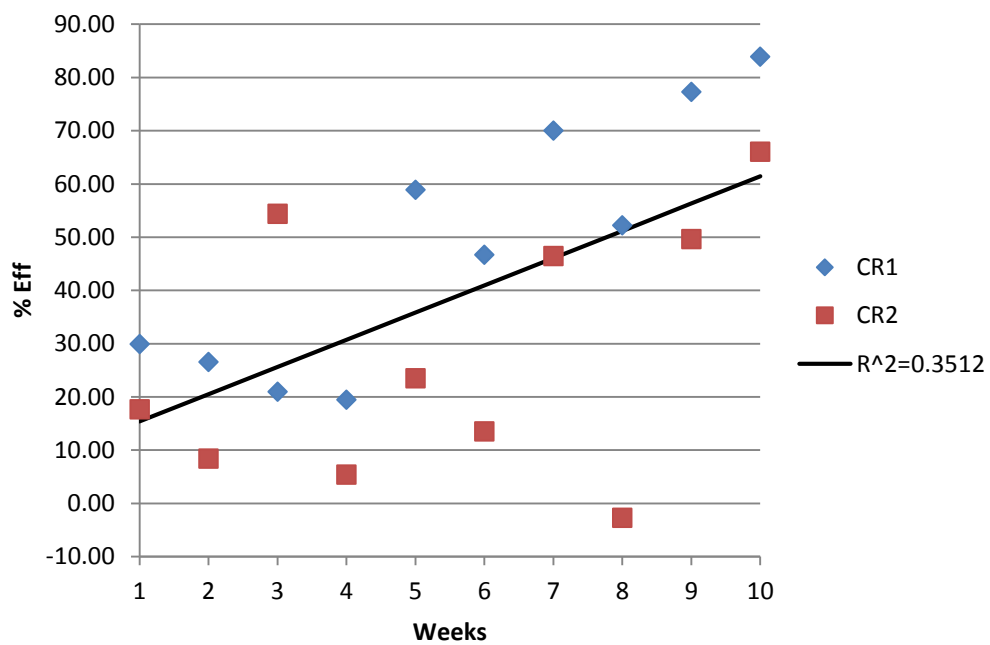

R Pb Concentration

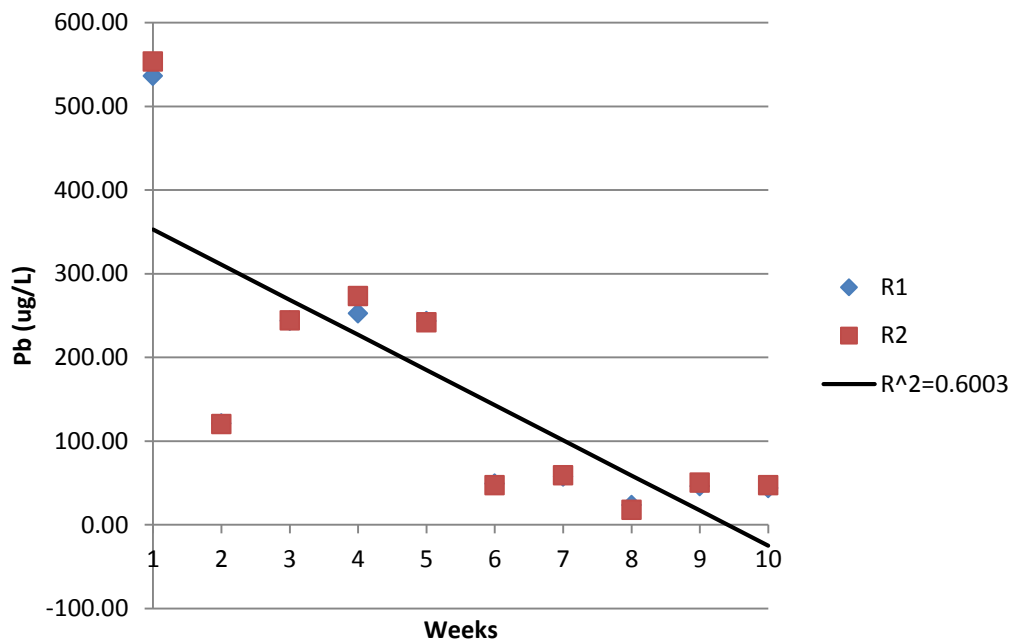

R Pb % Eff

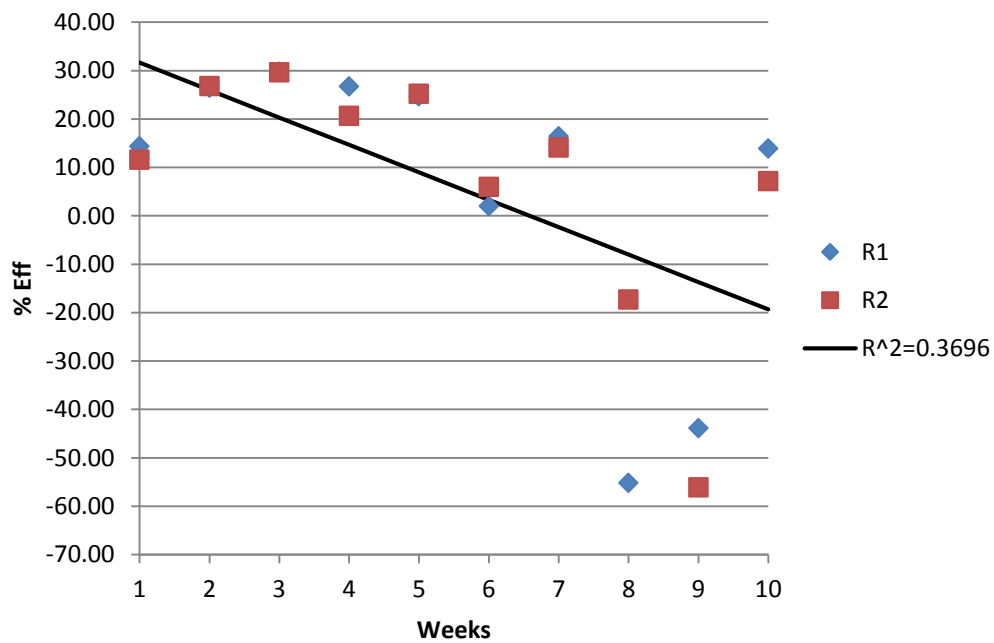

IN Pb Conc

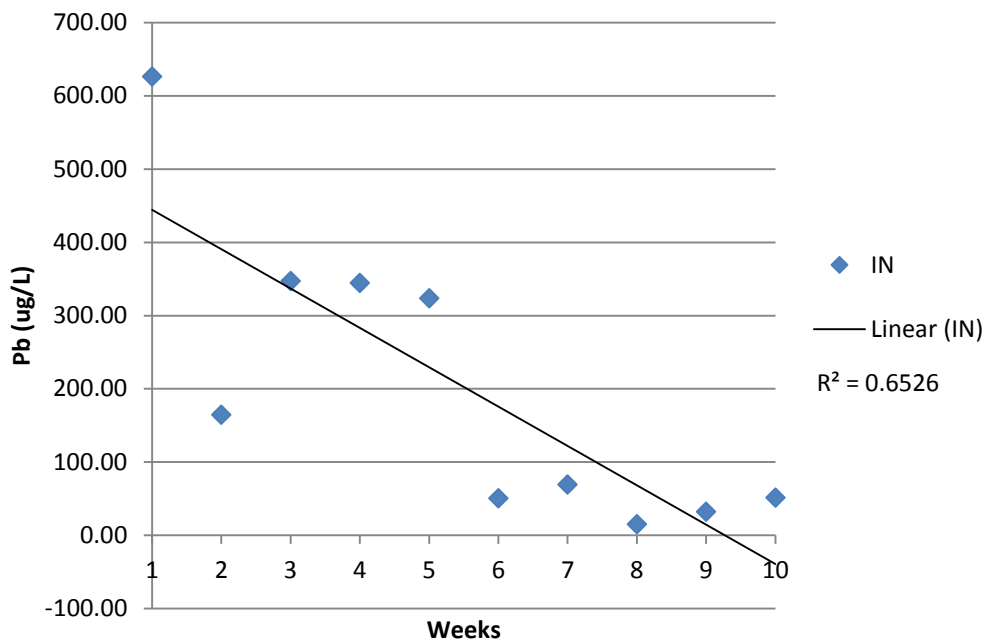

SLR TSS Concentration

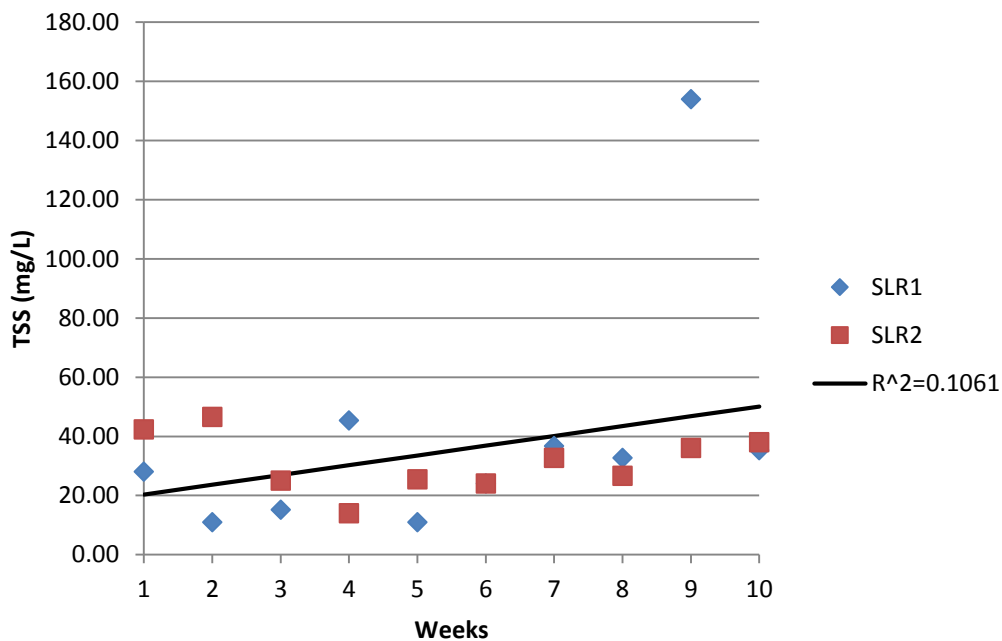

SLR Pb % Eff

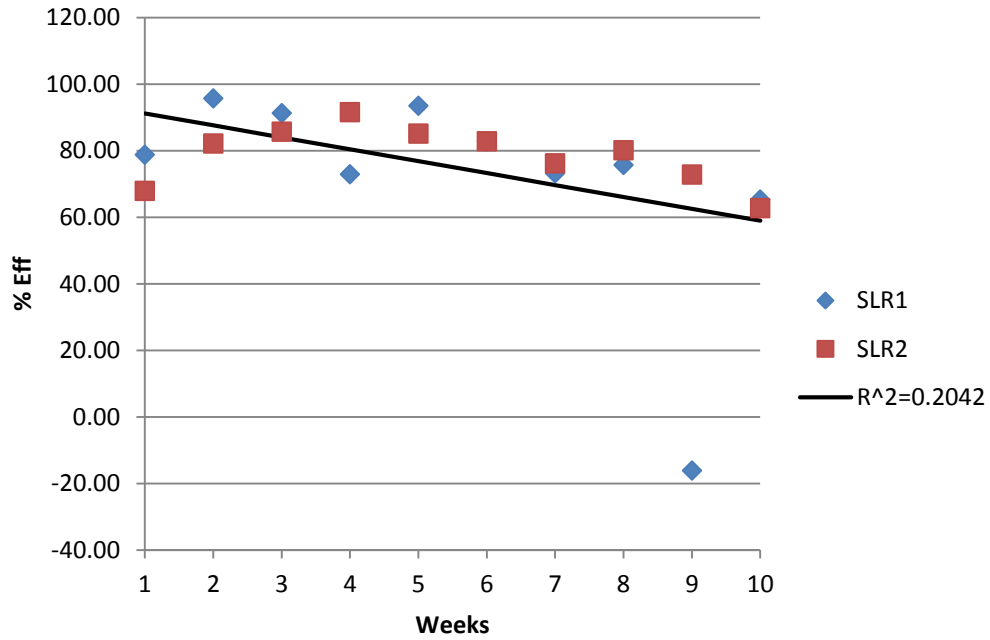

SR TSS Concentration

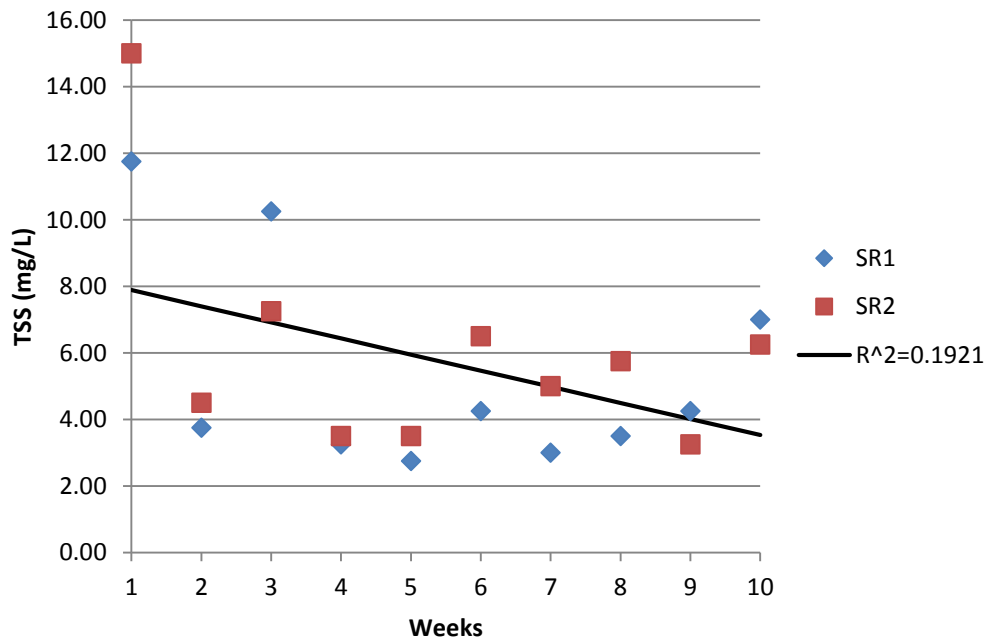

SR Pb % Eff

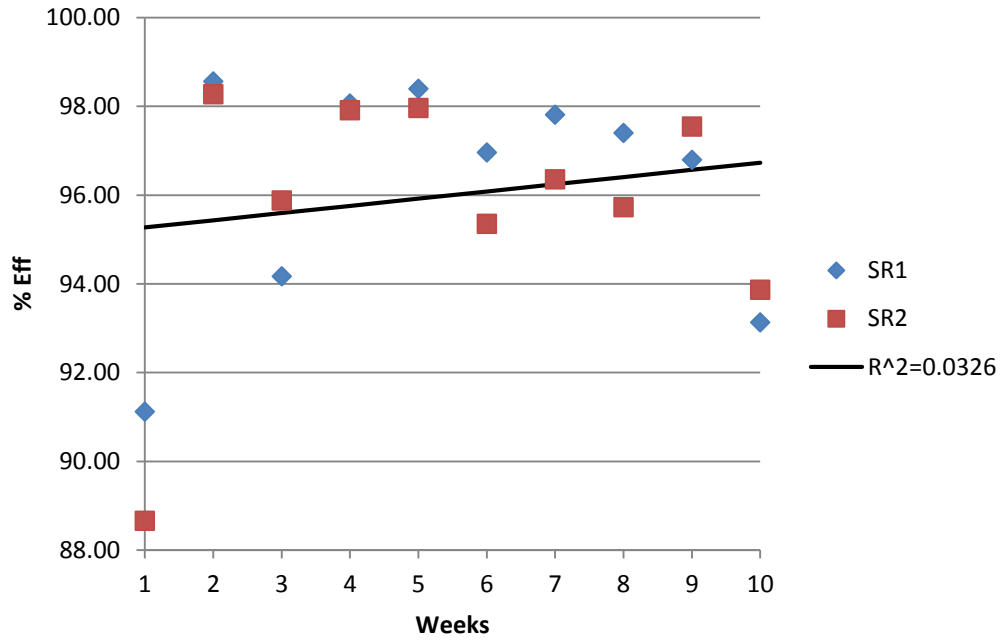

CR TSS Concentration

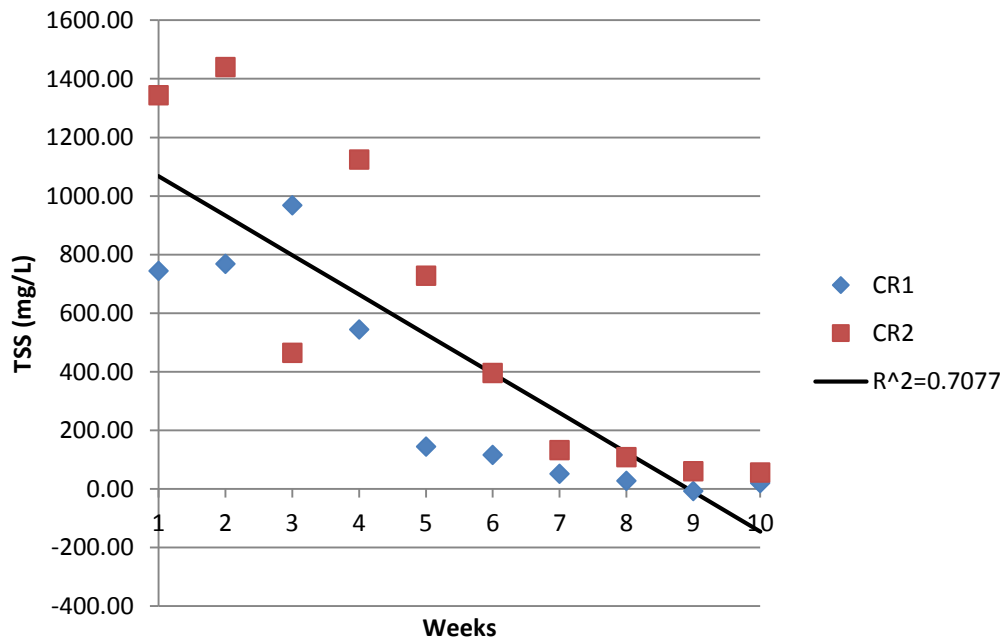

CR Pb % Eff

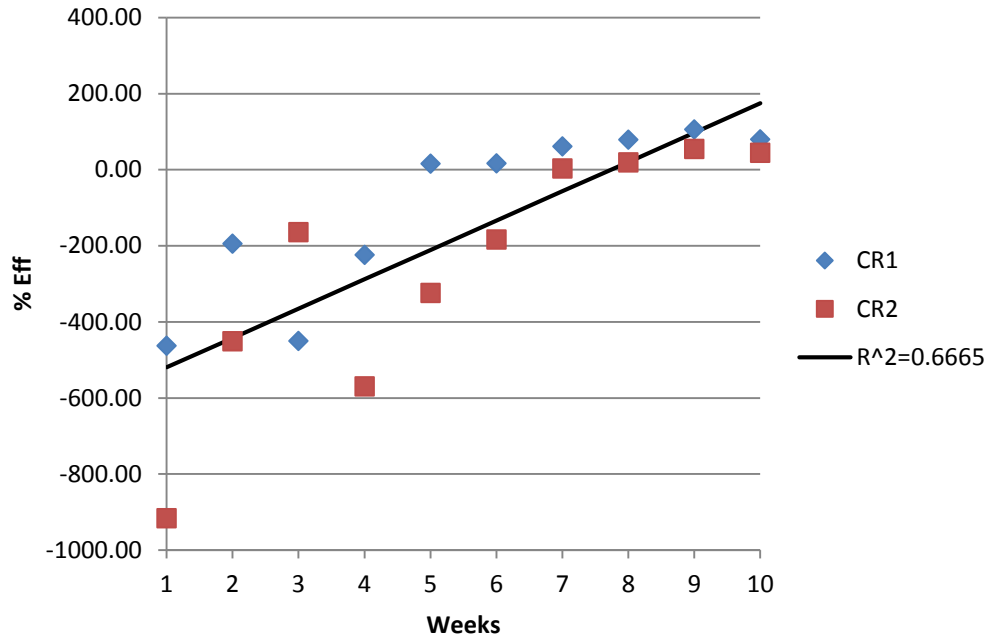

R TSS Concentration

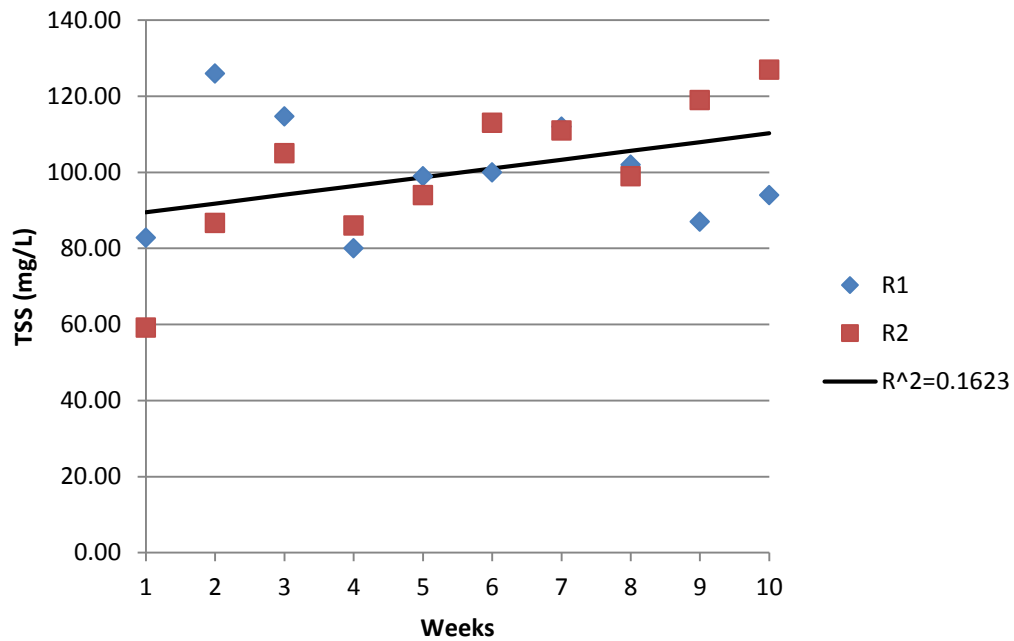

R Pb % Eff

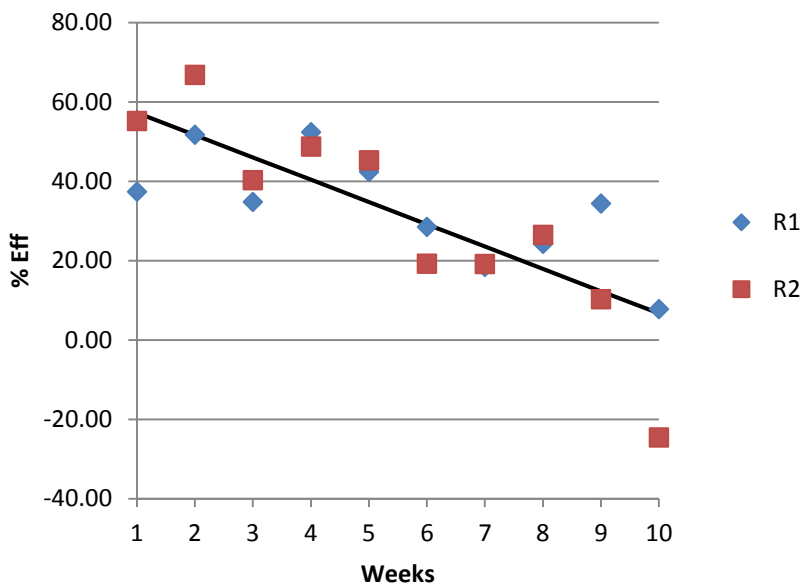

IN TSS Conc

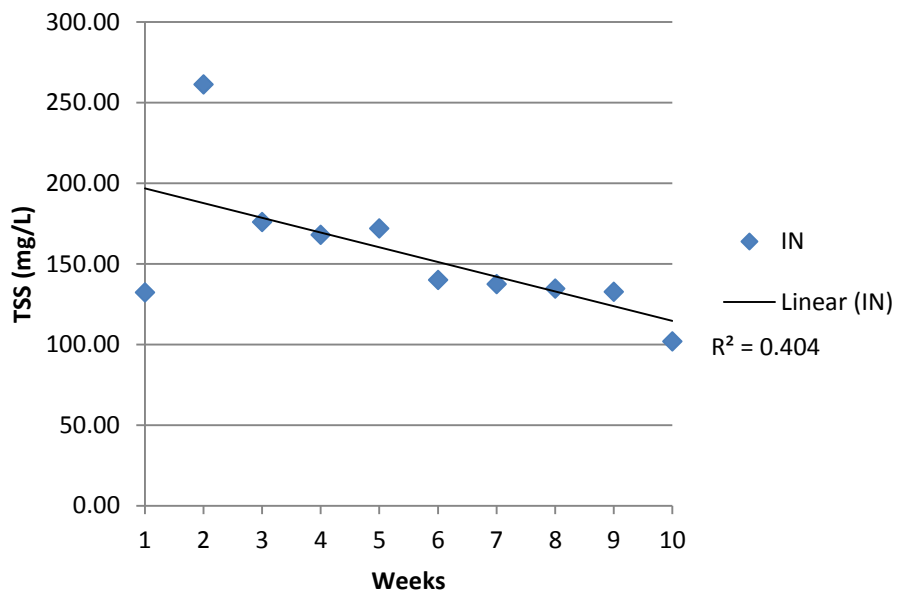

**DEVELOPMENT AND EVALUATION OF BEST MANAGEMENT PRACTICES
(BMPS) FOR HIGHWAY RUNOFF POLLUTION CONTROL**

**PART II
CONTINUED MONITORING OF FIELD BMPS**

Table of Contents

Table of Contents	ii
List of Tables	iii
List of Figures	v
Chapter 1 Introduction	1
Chapter 2 Site Hydrology and Modeling	3
2.1 Introduction.....	3
2.2 Methods and Materials.....	4
2.3 Results and Discussions.....	12
2.4 Summary.....	16
Chapter 3 Monitoring of Field BMPs	17
3.1 Introduction.....	17
3.2 Bioretention Cells	17
3.3 Infiltration Trench.....	39
3.4 Filter Trench.....	42
3.5 Check Dam Filters	49
Chapter 4 BMP Lifespan and Feasibility.....	59
4.1 BMP Lifespan and TSS Mass Balance	59
4.2 Feasibility of Full-scale BMPs.....	63
4.3 Link between Lab-scale and Field-scale Tests	67
Chapter 5 Conclusions and Recommendations.....	70
5.1 Deliverables and Summary	70
5.2 Recommendations.....	71
References.....	72
Appendix A Individual HEC-HMS flowrates and grab sample times.....	75
Appendix B Vegetative Analysis Results	79
Appendix C Individual Grab Sample Results.....	83

List of Tables

Table 2.1 Subbasin areas and initial SCS curve numbers.....	5
Table 2.2 Initial lag times for each subbasin in the HEC-HMS Model.....	6
Table 2.3 2150 Area Velocity Flow Module Sensor Specifications (Teledyne ISCO).....	8
Table 2.4 General performance ratings for recommended statistics for a monthly time step (Moriassi et al. 2007).....	11
Table 2.5 Summary of individual storm events	14
Table 3.1 BMP objectives, methodology, and monitoring results.....	18
Table 3.2 Seed mixture for Nebraska region B (NDOR 2010).....	19
Table 3.3 Monthly rainfall depths (in) for Lincoln, NE ¹	19
Table 3.4 Methods for characterize soil properties.....	22
Table 3.5 Average Percent “green” from north and south photographs in bioretention cells	28
Table 3.6 Plant species sampled in bioretention cells for their classification	30
Table 3.7 Plant species found in bioretention cells that were planted in July 2012	31
Table 3.8 Bioretention cell plant density counts.....	31
Table 3.9 Bioretention cell plant height (inches).....	32
Table 3.10 Results from bioretention soil core samples with field crop recommendations	33
Table 3.11 Results from bioretention soil core samples with recommendations	35
Table 3.12 Summary of research findings on bioretention efficiency from Hunt (2004) .	36
Table 3.13 Properties of two composts used in engineered soil mixtures compared to LinGro.....	36
Table 3.14 Bioretention percolation test results	22
Table 3.15 Total solids interception results for the infiltration trench	42
Table 3.16 Side slope TSS concentrations.....	45
Table 3.17 Land types within the I-Street check dam filters watershed.....	54
Table 3.18 Mass of total solids passing #270 sieve found in 47-b media baskets.....	54
Table 3.19 Percolation rate of I-street check dams.....	55
Table 3.20 Results from total solids testing of surface and 47-b media samples ^a	56
Table 3.21 Texture analysis results from surface samples collected at I-street and a composite sample of the total solids passing the #270 sieve	57
Table 3.22 Saturated hydraulic conductivity results from I-street tests.....	58

Table 4.1 TSS and TS mass balance calculations.....	60
Table 4.2 Media dimensions for different BMPs tested	61
Table 4.3 Calculated BMP clogging lifespan based on filling of void space	61
Table 4.4 Estimated price breakdown per BMP and WQV	63
Table 4.5 UNL team material price estimate and quantities for media material used in Fall 2011.....	64
Table 4.6 UNL team material price estimate and quantities for material used in Fall 2011.....	65
Table 4.7 Amount and price of materials purchased at salt valley project site	65
Table 4.8 Comparison of physical characteristics of lab and field-scale BMP media	68
Table 4.9 Pros and cons of field and lab scale media testing	69
Table 5.1 Information on deliverables and related methodologies used in the project	70

List of Figures

Figure 2.1 Salt Valley BMP and Sampling locations	3
Figure 2.2 Salt Valley HEC-HMS Subbasins. Red lines indicate subbasin boundaries. Blue lines indicate longest flow path in each subbasin	4
Figure 2.3 Ditch cross sectional area at different depths at flow sensor location.....	9
Figure 2.4 Cumulative Rain Gauge depth (in) for salt valley project site	13
Figure 2.5 HEC-HMS flow rate vs. observed flow rate for storm 2.....	15
Figure 2.6 Flow rates at different BMP sampling points and time period for collecting grab samples (purple lines) for storm 2	15
Figure 3.1 Average Percent “green” from north and south photographs in bioretention cells	24
Figure 3.2 Grasses in the cell of 33% Compost 66% Expanded Shale on 5/24	25
Figure 3.3 Grasses in the cell of 50% Compost 50% Sand on 6/17	25
Figure 3.4 Grasses in the cell of 33% Compost 66% Expanded Shale on 6/17	26
Figure 3.5 Grasses in the cell of 50% Compost 50% Sand on 7/18	26
Figure 3.6 Weeds in the cell of 33% Compost 66% Expanded Shale on 8/19	27
Figure 3.7 Bioretention cell influent TSS vs. flow rate	38
Figure 3.8 Upstream infiltration trench basket rock and observation well.....	40
Figure 3.9 Observation well water depths as a function of time (in 2013) and rain events	41
Figure 3.10 Filter trench side slope TSS collector setup	43
Figure 3.11 Rain Gauge data with side slope collection dates shown as vertical lines	44
Figure 3.12 Side Slope TSS vs. time	46
Figure 3.13 Filter trench influent TSS vs. flow rate	47
Figure 3.14 Filter trench effluent TSS vs. flow rate	47
Figure 3.15 Filter trench TSS percent removal.....	48
Figure 3.16 47-b media sediment collection basket deployed at I street	50
Figure 3.17 Check dam filter gravel (blue circle) and surface sediment (red circle)	51
Figure 3.18 Particle-size limits as per classification schemes of i) USDA, U.S. Department of Agriculture; ii) CSSC, Canada Soil Survey Committee; iii) ISSS International Soil Sci. Soc.; and iv) ASTM American Society for Testing and Materials (Jones and Benton 2001).....	52

Figure 4.1 Yearly mass balance for TSS in the bioretention cells.....	61
Figure 4.2 Yearly mass balance for TS accumulation in the infiltration trench.....	61
Figure 4.3 Yearly mass balance for TSS in the filter trench.....	62
Figure 4.4 Yearly mass balance for TS accumulation in the check dam filter	62

Chapter 1 Introduction

In PART I of this report, we designed four types of BMPs: 1) bioretention cells; 2) infiltration trench; 3) filter trench; and 4) check dam filters. The bioretention cells, infiltration trench, and filter trench are located in Lincoln, Nebraska at Nebraska Department of Roads' (NDOR's) Salt Valley maintenance yard near Warlick Avenue. The check dam filters are located in Omaha, Nebraska at the I street on ramp and interstate I-80. NDOR constructed the four BMPs, and we then did testing and monitoring on these BMPs. Due to the limited rain events in summer 2012, we didn't have much chance to observe the performance of these BMPs. For the bioretention cells, the plants were seeded in July 2012, but they sprouted at the end of September, 2012, which gave us very limited observation about their growth, and thus, we did not have enough information to link the plant growth with media used in the bioretention cells. Therefore, we needed more time to observe the plant growth and performance of these BMPs. Between January and December 2013, we conducted Phase II of the project to continuously monitor these BMPs.

The objectives of Phase II studies were to complete the following tasks, along with the corresponding activities:

- Field monitoring of BMPs' performance.
 - *For plants in bioretention cells:* we monitored plant establishment, growth, and sustainability. Monitoring methods included visual

- observation, photographing, measurement of plant height and density, exposure conditions, and measurement of weed infestation.
- *For performance of BMPs and BMP conditions in general:* we monitored each BMP for sedimentation, clogging of the medium, filter fabric clogging, core samples and infiltration rates, and site picture documentation.
 - *For general information:* we collected information on weather conditions (sunny or rainy days), storm events, maintenance issues.
 - Evaluation of the feasibility of the developed BMPs for large-scale application.
 - We linked the performance of lab-scale BMPs with the field BMPs to improve our understanding of design and monitoring procedures of BMPs.
 - We assessed costs of BMP construction and operation based on selected MS4 boundaries.
 - We evaluated the related operation and maintenance issues.

The purpose of PART II of this report is to summarize the monitoring activities performed and related findings during the period between Jan. 1 and Dec. 31, 2013. This report presents the methodology used for site hydrology and the results of using the HEC-HMS flow model to simulate flows into different BMPS during different storm events. The report then presents the methodologies used and the monitoring results of the four BMPs. Observations and performance analysis are given for each of the four BMPs, followed by the conclusions and recommendations. Raw data, pictures, and some calculations/results are presented in the appendices.

Chapter 2 Site Hydrology and Modeling

2.1 Introduction

At the salt valley project site a rain gauge and flow sensor were deployed (Figure 2.1) to better understand the site hydrology and to relate this hydrology to the total solids loadings of the BMPs located at the site. From the rain gauge and flow sensor data, a HEC-HMS model was developed and calibrated to simulate the flows at the grab sample locations (Figure 2.1). From this hydrologic monitoring, 15 storms were simulated and about half of these storms were sampled to evaluate the impact of various solids on BMP's performance.

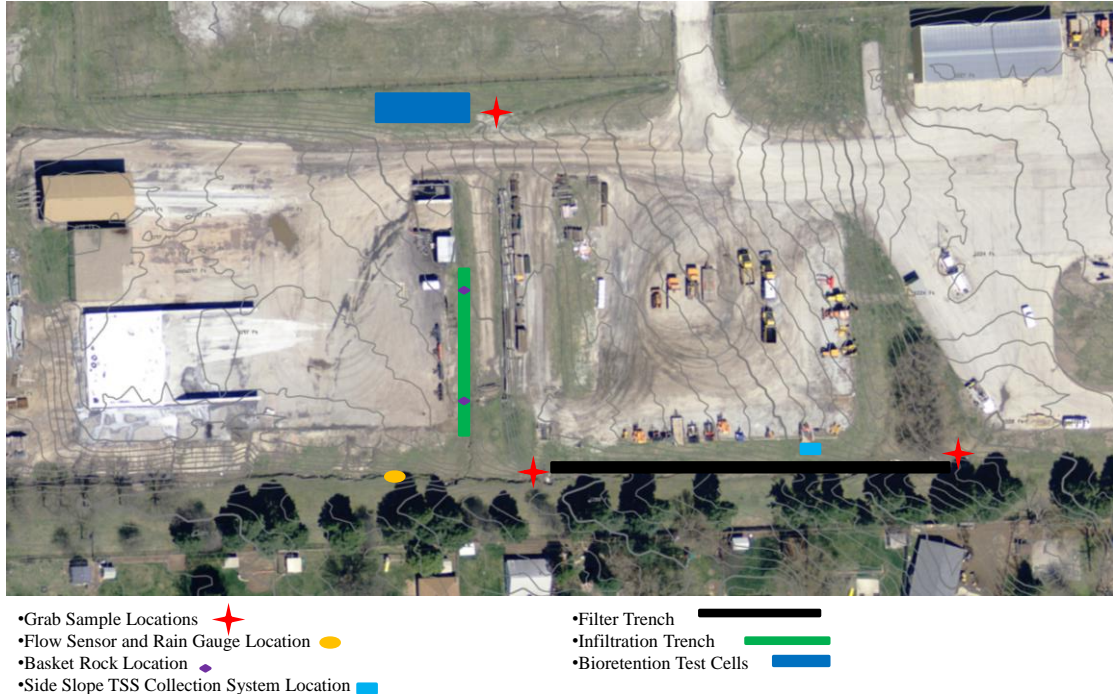

Figure 2.1 Salt Valley BMP and Sampling locations

2.2 Methods and Materials

HEC-HMS flow model. To have a better understanding of the hydrology at the salt valley project site a flow model was produced using the HEC-HMS computer program. In this model three subbasins and 3 reaches were used to describe the project site (Figure 2.2). The motivation to have a better understanding of the project site hydrology is to estimate the flow at each TSS collection point and to correlate the flow data with TSS values.

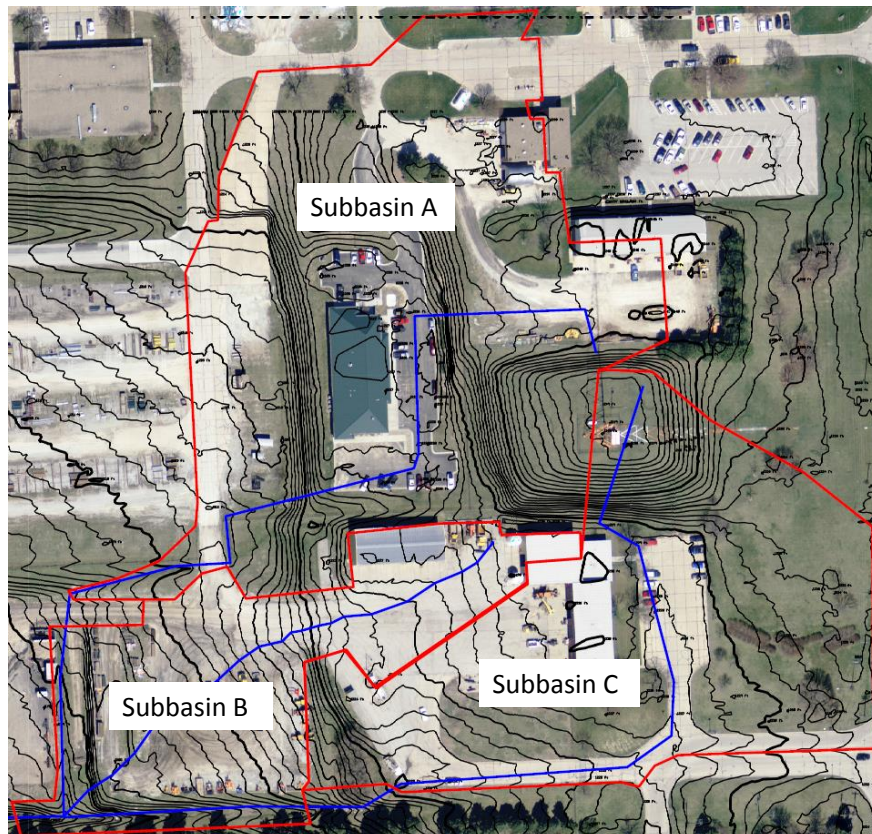

Figure 2.2 Salt Valley HEC-HMS Subbasins. Red lines indicate subbasin boundaries. Blue lines indicate longest flow path in each subbasin

The subbasin areas were found from scaled aerial images and contour images provided by NDOR. These images were imported into AutoCAD Civil 3D 2012 where the basin areas were traced and calculated. The subbasin areas can be found in Table 2.1.

Table 2.1 Subbasin areas and initial SCS curve numbers

Subbasin	land Use Areas (acres)			Total Area (acres)	Composite C.N
	Grass	Impervious	Gravel		
A	2.867	2.694	0	5.561	93.36
B	0.6464	0.774	1.05	2.47	95.64
C	2.662	1.389	0	4.045	92.08

For this study, the model uses the SCS curve number method to estimate cumulative losses (National Resource Conservation Service (NRCS) 1986). This method was used because the input data were easily accessible such as land use, antecedent moisture content and soil type. Also, the SCS method is applicable to the Midwest region of the United States. The input values needed for this method per subbasin are the composite SCS curve numbers and percent impervious. For this model the percent impervious was assumed to be zero and the SCS curve number for impervious areas was assigned to be 98. The initial curve numbers used in the model before HEC-HMS optimization was run can be found in Table 2.1

The transform method used for the subbasins in the model was the SCS unit hydrograph method (National Resource Conservation Service (NRCS) 1986). The input variables needed for this method were the graph type and lag time. The graph type used was standard, and the lag times were calculated based on the land use and slope. The

initial lag times before HEC-HMS optimization was run can be found in Table 2.2 (Gupta 2008).

Three reaches or channels were used in the HEC-HMS model. These reaches included 1) the reach from the bioretention cells to the junction downstream of the filter trench, 2) the reach in which the filter trench is located and 3) the short reach from the junction downstream of the filter and infiltration trench to the flow sensor. The reach routing method used during calculations was the Kinematic wave method (USACE-HEC 2000). For this method the length, slope, Manning's number, shape and side slope of the channel were needed and varied slightly for each reach.

Table 2.2 Initial lag times for each subbasin in the HEC-HMS Model

Subbasin	Surface Flow Material/ Condition	Length of Flow Path (ft)	Lag Time (min)
Subbasin A	Grass/Pavement	685	4.27
Subbasin B	Gravel/Pavement	530	1.88
Subbasin C	Grass/Pavement	741	4.77

Model Calibration and Data Collection. To accurately estimate the flow rates at the different sampling locations the HEC-HMS model needed to be calibrated. To calibrate the model, a flow sensor and rain gauge were deployed at the Salt Valley project site. Then the data from the rain gauge were input into HEC-HMS optimization routine. Rain gauge data were input into the HEC-HMS as cumulative depth of precipitation at one-minute intervals.

A data logging rain gauge (ONSET model RG-3) was deployed at the project site on 4/8/2013 and remained at the site functioning until the end of the observation period. The rain gauge was a tipping-bucket style where each tip represented 0.01 inches of rain, and the tips could be recorded as fast as one tip per second. The rain gauge data was input into the HEC-HMS model as cumulative depth of rain in inches.

To measure the flows at the project site, an ISCO 2150 Area Velocity Flow Sensor was deployed on 4/8/2013. The specifications of the sensor can be found in Table 2.3. The sensor was placed just downstream of the BMP (Figure 2.1). This was done because the reference flow required for optimization in the HEC-HMS modeled needs to be downstream of the subbasins being optimized. The flow meter uses a pressure transducer and a Doppler sensor to measure the depth and velocity of flow, respectively. To calculate the flow rates the sensor multiplies the stream cross sectional area by the stream velocity. To calculate the channel cross sectional area the sensor uses level-to-area conversions with equation options of different channel shapes or data point entries. The channel shape used at the location of the flow sensor was U-shape with a total depth of 39 inches and a top width of 26 ft. A depth vs. cross sectional area chart of the ditch cross sectional can be found in Figure 2.3. Flow, velocity and depth data were recorded at 5-minute intervals, and the observed flow data were input into the HEC-HMS model at 5 minute intervals.

After the observed flow and rain gauge data were input into the HEC-HMS model optimization could be completed. Optimization is a process where the initial parameter values are estimated and adjusted, so that the simulated flows fit the observed flows as

closely as possible. Optimization within the HEC-HMS model can be done by two search algorithms and seven objective functions that measure the goodness-of-fit of the simulated flows to the observed flows. The two search algorithm options provided in HEC-HMS are the Univariate-gradient and the Nelder and Mead methods. The seven objective functions provided in the HEC-HMS program are Peak-Weighted RMS Error, Percent Error Peak, Percent Error Volume, RMS Log Error, Sum Absolute Residuals, Sum Squared Residuals, and Time-Weighted Error.

Table 2.3 2150 Area Velocity Flow Module Sensor Specifications (Teledyne ISCO)

Level Measurement		
Method	Submerged pressure transducer mounted in the flow stream	
Transducer Type	Differential linear integrated circuit pressure transducer	
Range ¹	0.033 to 10 ft. (optionally) up to 30 ft.	0.010 to 3.05 m 9.15 m
Maximum Submersible Depth	34 ft	10.5 m
Accuracy ²	± 0.010 ft	± 0.003 m
Typical Long Term Stability	± 0.023 ft/yr	± 0.007 m/yr
Compensated Temperature Range	32 – 122°F	0 – 50°C
Velocity Measurement		
Method	Doppler Ultrasonic	
Frequency	500 kHz	
Transmission Angle	20° from horizontal	
Typical Minimum Depth for Velocity Measurement	0.08 ft	25 mm
Range	-5 to +20 ft/s	-1.5 to +6.1 m/s
Accuracy ³	Velocity -5 to +5 ft/s (-1.5 to +1.5 m/s) 5 to 20 ft/s (1.5 to 6.1 m/s)	Error ±0.1 ft/s (±0.03 m/s) ±2% of reading

1. Actual vertical distance between the area velocity sensor and the liquid surface
2. Maximum error within compensated temperature range (per degree of change from calibration temperature)
3. In water with uniform velocity profile and a speed of sound of 4850 ft/s (1480 m/s)

To exhaust all possibilities of best fit, a total of 14 model runs were done using each

of the 7 objective functions with both search methods. To supplement the goodness-of-fit statistics offered by the HEC-HMS program, four other statistical methods were used to compare observed and simulated flows. The four statistical equations used were Nash-Sutcliffe Efficiency (NSE), Percent Bias (PBIAS), RMSE-observations standard deviation ratio (RSR), and coefficient of determination (R^2). Based on these four statistical methods, it was found that the Sum of Squared Residuals objective function (Eq. 2-5) with the Univariate-gradient search method had the best fit with NSE, PBIAS, RSR, and R^2 values of 0.611, -15.65%, 0.624, and 0.837 respectively.

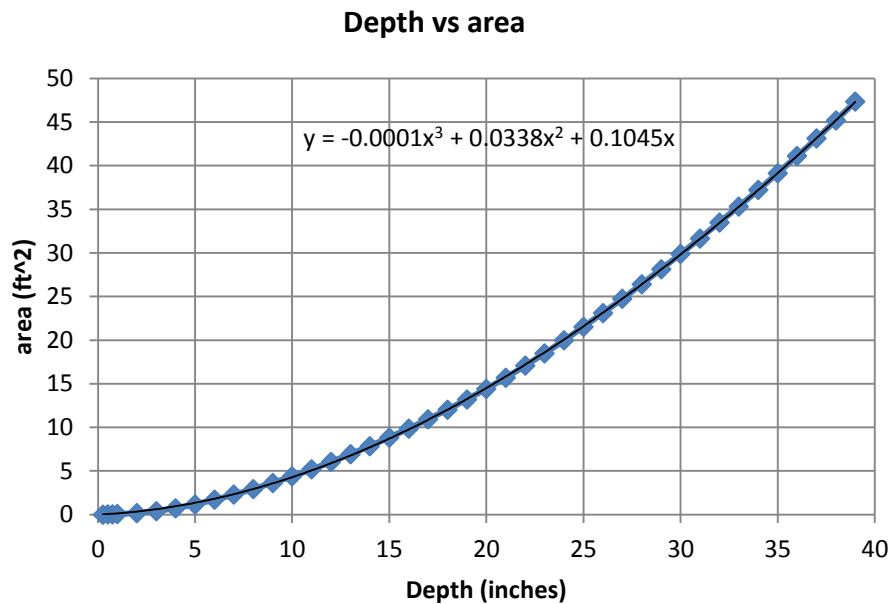

Figure 2.3 Ditch cross sectional area at different depths at flow sensor location

$$NSE = 1 - \left[\frac{\sum_{i=1}^N (Y^{obs} - Y^{sim})^2}{\sum_{i=1}^N (Y^{obs} - \overline{Y^{obs}})^2} \right] \quad 2-1$$

$$PBIAS = \left[\frac{\sum_{i=1}^N (Y^{obs} - Y^{sim}) * 100}{\sum_{i=1}^N Y^{obs}} \right] \quad 2-2$$

$$RSR = \frac{RMSE}{STDEV_{obs}} = \frac{\left[\sqrt{\sum_{i=1}^N (Y^{obs} - Y^{sim})^2} \right]}{\left[\sqrt{\sum_{i=1}^N (Y^{obs} - \overline{Y^{obs}})^2} \right]} \quad 2-3$$

$$R^2 = \frac{\left[\sum_{i=1}^N (Y^{obs} - \overline{Y^{obs}})(Y^{sim} - \overline{Y^{sim}}) \right]^2}{\left[\sum_{i=1}^N (Y^{obs} - \overline{Y^{obs}})^2 \right] \left[\sum_{i=1}^N (Y^{sim} - \overline{Y^{sim}})^2 \right]} \quad 2-4$$

$$Z = \sum_{i=1}^N [Y^{obs} - Y^{sim}]^2 \quad 2-5$$

where

Y^{obs} = is the observed stream flow at the i th time step

Y^{sim} = is the simulated stream flow at the i th time step;

$\overline{Y^{obs}}$ = is the observed mean stream flow for the time period

$\overline{Y^{sim}}$ = is the simulated mean stream flow for the time period; and

N = is the number of observations

Z = is the objective function value

The Nash-Sutcliffe Efficiency equation value ranges from $-\infty$ to positive 1 with 0 to 1 being acceptable values and 1 being the optimal value. The NSE is a normalized statistic that determines the relative magnitude of the residual variance (“noise”) compared to the measured data variance (“information”) (Moriasi et al. 2007). The closer the value of NSE is to 1 the better the predictive power of the model is (Hutchinson and Christiansen 2013). Different performance ratings for monthly time steps for the NSE can be found in Table 2.4. Although Table 2.4 is based on the monthly time step it was still

used as a basis for statistical model rankings because other literature based on daily time steps could not be found.

Table 2.4 General performance ratings for recommended statistics for a monthly time step (Moriiasi et al. 2007)

Performance Rating	RSR	NSE	PBIAS	R ²
Very Good	0.00 < RSR ≤ 0.50	0.75 < NSE ≤ 1.00	PBIAS < ±10	-
Good	0.50 < RSR ≤ 0.60	0.65 < NSE ≤ 0.75	±10 ≤ PBIAS < ±15	-
Satisfactory	0.60 < RSR ≤ 0.70	0.50 < NSE ≤ 0.65	±15 ≤ PBIAS < ±25	R ² > 0.5
Unsatisfactory Model Values	RSR > 0.70 0.624	NSE < 0.50 0.611	PBIAS ≥ ±25 -15.65	- 0.837

The Percent Bias equation used in calibration has a value range from $-\infty$ to $+\infty$ with an optimal value of 0 which would represent a perfectly accurate model. Positive values indicate model underestimation bias, and negative values indicate model overestimation bias (Gupta et al. 1999). The PBIAS is a good indicator of water balance errors and volume errors. Different performance ratings for monthly time steps for the PBIAS can be found in Table 2.4.

The RMSE-observation standard deviation ratio was developed as the ratio of the root mean square error over the standard of deviation of the observed flows and was suggested by (Singh et al. 2004). This ratio was developed to mathematically classify what was a “low” RMSE value (with a low value being one that is less than 0.5 and an optimal value of 0). Different performance ratings for monthly time steps for the RSR can be found in Table 2.4.

The R^2 value is the proportion of the variability in the measured data that is explained by the simulated data, and is the measure of the strength of the linear relation between predicted and measured values (Hutchinson and Christiansen 2013). The value of R^2 can range from 0 to 1 with values closer to one being better and 1 being optimal. Values of R^2 higher than 0.5 are considered satisfactory based on (Gassman et al. 2007). Different performance ratings for monthly time steps for the R^2 can be found in Table 2.4.

2.3 Results and Discussions

Summary of Storm Events. Through the monitoring period of this research, 15 storms were recorded on the flow sensor and rain gauge (see Table 2.5). Of these, storms seven were able to be grab sampled for TSS by the research team. Some storms were missed because of safety reasons due to lightning associated with thunderstorm warnings.

The total rain depth during the monitoring period was 15.49 inches. Figure 2.4 shows the cumulative rain depth over time for the salt valley project site. This figure was developed from the raw data of the tipping bucket rain gauge where the more vertical sections of the line on the graph represent higher intensity periods of rain.

Model Results. Figure 2.5 is an example graph of the comparison of the observed and model simulated flows at the flow sensor location. This resulting model data are based on the statistical methods explained before.

The resulting flows from the HEC-HMS model were used to estimate flows at the TSS grab sample points located at the beginning and end of the filter trench and at the

diversion inlet of the bioretention cells. This was done to relate TSS values to flows in search of the correlation between TSS and flow rates. The correlation results of TSS vs. flow rates can be found in chapter 3 for the respective BMPs. Figure 2.6 shows the flows at the sample points during grab sample collection during the rain event on 4/17/13.

Other grab sample storm event data and figures can be found in Appendix A.

Another reason for monitoring rain amounts and flow rates was to correlate different rain events to the amount of TSS collected from a portion of the side slope of the filter trench. The results and discussion of the side slope TSS collection can also be found in chapter 3.

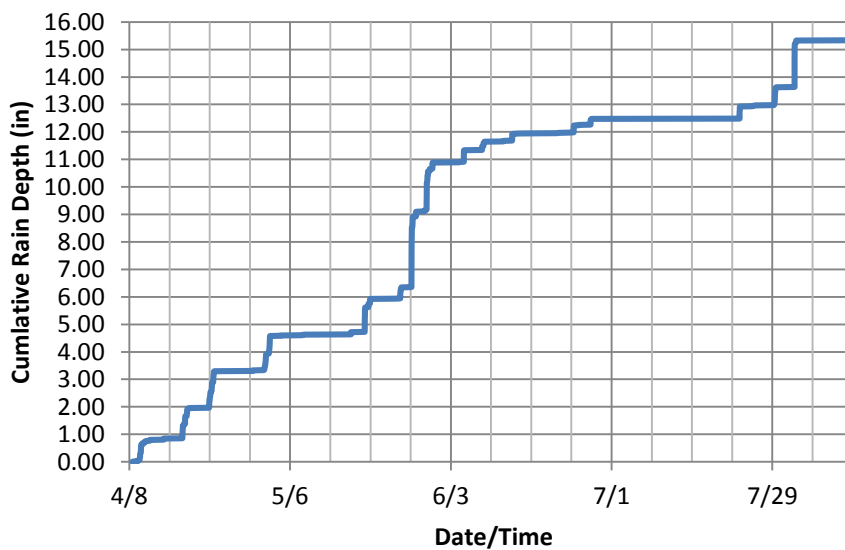

Figure 2.4 Cumulative Rain Gauge depth (in) for salt valley project site

Table 2.5 Summary of individual storm events

storm #	Rain gauge tipping bucket		Duration (hr)	Rain Depth (in)	Observed peak flow at sensor (cfs)	HEC-HMS estimated peak flow at sensor (cfs)	Grab samples		Duration of side slope bucket deployed	Side slope TSS (mg/L)	Average filter trench influent TSS (mg/L)	Average filter trench effluent TSS (mg/L)	Average bioretention influent TSS (mg/L)	Storm notes
	First tip Date/time	Last tip Date/time					Start Date/time	End Date/time						
1	4/9 05:26	4/11 13:35	56.15	0.79	2.749	0.544	N/C	N/C	4/8-4/16	2493.3	N/C	N/C	N/C	
2	4/17 05:04	4/18 11:21	30.28	1.08	3.169	2.757	4/17 06:30	4/17 11:15	4/16-4/21	5490	115.92	299.96	52.83	
3	4/21 20:41	4/22 18:43	22.03	1.34	2.529	2.025	N/C	N/C	4/21-5/3	1250	N/C	N/C	N/C	
4	5/1 09:37	5/2 11:40	26.05	1.25	2.099	2.423	5/1 11:30	5/1 15:15	4/21-5/3	1250	53.37	91.53	16.13	
5	5/18 23:11	5/19 22:23	23.20	1.21	5.000	7.606	5/18 23:00	5/19 01:00	5/18-5/25	1284	137.67	190.39	16.50	
6	5/25 03:59	5/25 08:38	4.65	0.41	1.680	3.816	5/25 08:00	5/25 10:45	5/18-5/25	1284	101.82	175.50	21.17	
7	5/27 02:45	5/30 20:00	89.25	4.54	14.859	19.213	N/C	N/C	N/C	N/C	N/C	N/C	N/C	side slope collection clogged
8	6/4 10:51	6/5 07:17	20.43	0.45	3.571	7.433	N/C	N/C	N/C	N/C	N/C	N/C	N/C	side slope collection clogged
9	6/8 09:53	6/8 20:08	10.25	0.31	0.446	1.940	N/C	N/C	N/C	N/C	N/C	N/C	N/C	side slope collection clogged
10	6/12 03:48	6/15 09:54	78.10	0.30	1.017	2.138	N/C	N/C	N/C	N/C	N/C	N/C	N/C	side slope collection clogged
11	6/23 14:05	6/24 10:19	20.23	0.27	1.378	3.635	N/C	N/C	6/20-6/28	1420	N/C	N/C	N/C	
12	6/27 07:28	6/27 12:12	4.73	0.22	1.159	3.032	6/27 12:00	6/27 13:00	6/20-6/28	1420	62.10	44.00	18.67	
13	7/23 06:26	7/23 08:03	1.62	0.45	1.014	5.311	N/C	N/C	6/28-7/28	598	N/C	N/C	N/C	
14	7/29 06:05	7/29 16:03	9.97	0.66	1.382	2.689	7/29 09:15	7/29 11:45	7/28-8/1	634	96.92	61.00	11.17	
15	8/1 20:19	8/2 03:32	7.22	1.70	10.110	28.482	8/1 20:30	8/1 23:15	8/1-8/6	524	109.83	58.67	12.13	

NC = Not collected

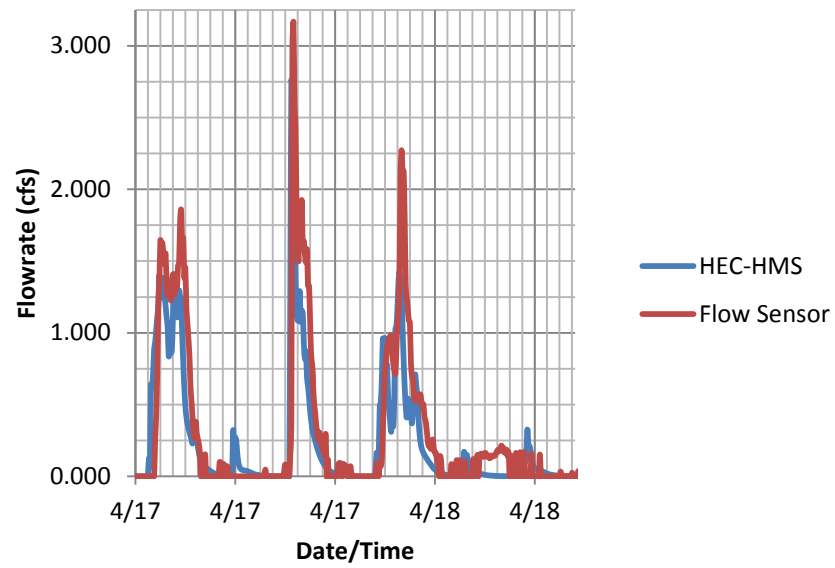

Figure 2.5 HEC-HMS flow rate vs. observed flow rate for storm 2

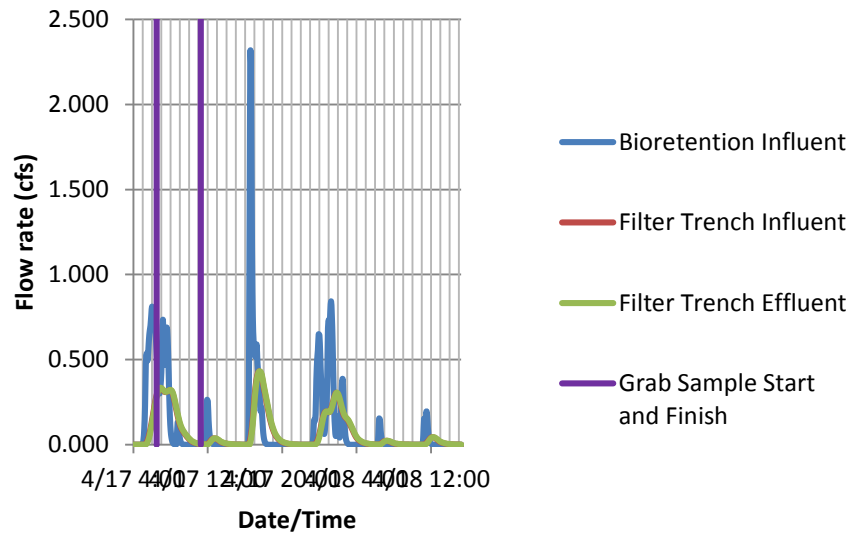

Figure 2.6 Flow rates at different BMP sampling points and time period for collecting grab samples (purple lines) for storm 2

2.4 Summary

Through the data collection from the rain gauge and flow sensor, a HEC-HMS model was developed. After optimization of the model's parameters based on measured flow rates and statistical methods, the flow rates of different BMPs were simulated and then used throughout the rest of the project for comparing TSS and flows within the BMPS at the Salt Valley project site. Also through data collection 15 storms were logged with a majority of the storms having TSS grab or side slope samples collected. The results from this chapter are used to support information presented in chapter 3.

Chapter 3 Monitoring of Field BMPs

3.1 Introduction

Bioretention cells were filled with media based on literature reviews and objectives of this project. Four soil mixtures were used: 1) 50% grout sand and 50% compost; 2) 40% NDOR 47-B gravel and 60% compost; 3) 30% loam, 50% grout sand and 20% wood mulch; and (4) 33% compost and 66% expanded shale. These cells were monitored for vegetative growth, soil media composition and percolation rate among others. The infiltration trench located at the Salt Valley project site was monitored for total solids interception and water drawdown rate. The filter trench located at the Salt Valley project site was monitored for total suspended solids loading from the side slope of the trench and from the concrete area of the watershed. The check dam filters located at the I-street project site were assessed for clogging during the monitoring period. Total solids were tested and monitored; percolation rates were tested; and saturated hydraulic conductivities were analyzed. Table 3.1 summarizes the objectives, methodology used, and major monitoring results obtained during the period of Phase II.

3.2 Bioretention Cells

3.2.1 Methods and Materials

Vegetation Monitoring. Monitoring methods were established to monitor the growth and establishment of vegetation in the four bioretention cells at the Salt Valley project site. Three criteria used were: i) Image J analysis for general green vegetation density (plant count) based on photography, ii) plant height, and iii) types of plants. The

objective of this monitoring was to find out the best bioretention media for plant growth and establishment.

Table 3.1 BMP objectives, methodology, and monitoring results

BMP	Monitoring objectives	Methodology	Results
Bioretention Cells	1. Plant growth 2. Influent TSS conc.	1. Use image J to analyze vegetation pictures 2. Measure plant height 3. Identify plant species 4. Collect grab samples in rain events	30/50/20 loam/sand/wood mulch, and 50/50 compost/ sand are the best cells
Filter Trench	1. TSS loading to BMP 2. Side slope TSS conc.	1. Collect grab samples of rain events 2. Collect TSS samples with a device to intercept side slope runoff into a five-gallon buckets	Has a TSS removal ranging from -275% to about 75%; the side slope of the filter trench contributed a certain amount of the solids loading.
Infiltration Trench	1. Sediment interception 2. Infiltration rate	1. Find TS with a golf ball basket filled with the same media as the trench 2. Record water levels in both observation pipes	It had minimal sediment clogging (average TS =2.04 g/L of rock); slow drawdown times in spring
Check Dam Filters	1. Assess BMP clogging 2. Sediment interception	1. Take soil samples and analyzing for total mass of sediments passing the #270 sieve 2. Find TS with a screen basket filled with the same media as the check dam	Experienced significant clogging by the disturbed soil due to construction; drawdown times were still within the range for operation

The vegetation was planted at the beginning of July of 2012 with NDOR shoulder seed mixture (Table 3.2). Minimal rainfall occurred during the following months after planting in 2012. Because of the minimal rainfall in 2012, continued monitoring of the vegetation establishment took place for the growing season in 2013. Comparative rainfall depths from 2012 and 2013 can be found in Table 3.3. Images of each bioretention test cell were taken by looking south at the cells and looking north at the cells initially on a bi-weekly basis followed by a weekly basis. The bi-weekly period was from 4/29/13 to 6/17/13, and the weekly monitoring period was from 6/17/13 to 8/5/13. The change in monitoring frequency was done because the research team felt that a smaller interval of image analysis was needed.

Table 3.2 Seed mixture for Nebraska region B (NDOR 2010)

Rural Highway Shoulder Mixture		
Species	Minimum Purity (percent)	Lbs. of PLS/acre
Perennial ryegrass – Linn	85	7
Slender wheatgrass	85	4
Western wheatgrass – Flintlock, Barton	85	6
Kentucky fescue	85	1.5
Blue grama – NE, KS, CO	30	2
Buffalograss – Cody, Bison, Sharp’s Improved, Texoka	80	4
Sideoats grama – Trailway, Butte	75	3
Sand dropseed (<i>Sporobolus cryptandrus</i>)	90	0.2
Oats/Wheat (wheat in the fall)	90	14

Table 3.3 Monthly rainfall depths (in) for Lincoln, NE¹

Month	2012	2013	Difference
1	0.16	0.64	0.48
2	2.69	0.33	-2.36
3	1.14	2.13	0.99
4	3.67	4.17	0.5
5	2.98	7.94	4.96
6	5.03	2.11	-2.92
7	0.12	1.33	1.21
8	0.69	2.03	1.34
9	1.87	2.75	0.88
10	1.1	4.09	2.99
11	0.27	1.25	0.98
12	2.17	-	-
Total	21.89	28.77	6.88

¹(National Climatic Data Center (NCDC) 2012)

²December data not available at time of report writing

All digital photos were taken using a Canon PowerShot A495 with 10.0 Megapixels with a Canon zoom lens 3.3X. After photos were taken they were loaded onto a personal computer, cropped and analyzed with Image J software. To analyze the

percent “green” in each image, the hue, saturation, and brightness were adjusted to 47-107, 0-255, and 0-255, respectively. The hue spectrum was set to 47-107 as suggested by (Patton et al. 2005), which leaves out other colors of the spectrum from 0-46 and 108-255 which represent yellows blues and reds etc. The brightness and saturation were set to the full range to help reduce affects from shadows.

The maximum plant height in each test cell was measured using a meter stick on 8/5/2013. The maximum plant height was used because to measure the average plant height in each cell would have been a subjective method and because of difficulties in plant species selection to measure. Lastly, the number of plant species types in each cell was monitored. To do this individual plant species were pulled and photographed on a piece of white paper on 8/5/2013 and the images were sent to NDOR research team biologists for classification. The plants classified were considered to be the most prevalent plant species in each cell. After the pulled plants were classified the NDOR research team made a site visit on 8/16/2013 to evaluate the plant species in the field. During this site visit the NDOR team found several other species of importance (see below).

Once the plant species in the cells were classified, the plant density was measured on 9/1/2013. To measure the plant density (count) a square (1ft by 1ft) was placed in three locations in each test cell. The three placement locations were the densest, least dense, and average density of plants in the cell based on the sampler’s judgment. Once the square was placed, each individual species was counted at the base of the plant and recorded.

Soil Core Samples. Before and after the growing season of 2013 soil core samples of each of the four bioretention cells were taken and analyzed on February, 18, 2013 and on October 1, 2013. The samples were taken to Midwest Laboratories, Inc. and tested for moisture content, organic matter, phosphorus, and other parameters listed in Table 3.4. The samples were taken using standard sampling protocols given by Midwest laboratories website (<https://www.midwestlabs.com/>). Before testing, the samples were sieved through a #10 sieve to extract large particles such as small pebbles and rocks or vegetative matter that would disrupt testing. The objective of taking soil core samples before and after the growing season in each test cell was to compare the soil properties in each cell, and to compare any changes in the bioretention soil through one growing season as well.

Percolation Test. A percolation test was performed on the four bioretention cells on August, 18th 2013. The methods for this test are described in *Small and Decentralized Wastewater Management Systems* (Crites and Tchobanoglous 1998). The test location was located in the center of each test cell with the test hole being 4 inches diameter by 8 inches deep. Water was added until the test hole was filled. Then the time for the water to drain the total depth was recorded. The percolation test was performed towards the end of the growing season with the motivation that the plant roots from one full growing season and one part season could contribute to the percolation rate.

TSS Grab Sample. As shown in Table 2.5 in Chapter 2, seven storms were sampled for TSS using grab sample methods. The grab sample location was at the influent to the bioretention cells. Grab samples were collected by the research team at the

beginning of the storm when possible. Some sampling events were missed due to thunderstorms with the safety of the sampling team in mind. The sampling procedure (rinsing the sample bottle twice then filling it) was initiated once enough flow was observed to complete the procedure within a 15 minute time frame. After the first sample was collected, the following samples were taken approximately every 15 minutes. All samples were collected in 1-L Nalgene bottles. After collection, sample bottles were preserved with ice and taken back to the lab for TSS analysis as per EPA method 2540 D.

Table 3.4 Methods for characterize soil properties

Soil Property Tested	Method	Reference
Percent Organic Matter	Loss of Weight on Ignition	NCR ^a , p. 32
Phosphorus	a. P1 Extraction with dilute acid and ammonium fluoride (Weak Bray)/colorimetric	NCR, p. 14-15
a. P ₁		
b. P ₂	b. P2 Extraction with strong Bray solution (4 times the acid concentration of weak Bray)/colorimetric	
c. Bicarbonate P	c. Bicarbonate P Extraction with sodium bicarbonate/colorimetric	
Potassium	Neutral ammonium acetate (1 N) extraction/Inductively Coupled Argon Plasma (ICAP) detection	RMST ^b , p. 60-65 NCR, p.17-18
Magnesium	Neutral ammonium acetate (1 N) extraction/Inductively Coupled Argon Plasma (ICAP) detection	RMST, p. 60-65 NCR, p.17-18
Calcium	Neutral ammonium acetate (1 N) extraction/Inductively Coupled Argon Plasma (ICAP) detection	RMST, p. 60-65 NCR, p.17-18
Sodium	Neutral ammonium acetate (1 N) extraction/Inductively Coupled Argon Plasma (ICAP) detection	RMST, p. 60-65 NCR, p.17-18
pH	1:1 soil:water mixture/combination electrode	NCR, p. 5-8
a. Cation Exchange Capacity	a. Summation of cations, Ca ⁺⁺ , Mg ⁺⁺ , K ⁺ , (CEC) Na ⁺ , and H ⁺	ASA ^c , p. 149-151
b. Percent Base Saturation	b. Ammonium acetate saturation/displacement with NaCl/distillation and titration	
Nitrate-N	Saturated CaO Extraction/Cadmium Reduction/Segmental Flow Analysis (SFA)	NCR, p. 11
Soluble Salts	Conductivity meter 1:1 Soil:Water	USDA ^d , P. 89-90
Total Carbon	Combustion on a Leco Analyzer	Midwest Labs
Total Nitrogen	Combustion on a Leco Analyzer	Midwest Labs
Moisture Content	Vacuum oven at 105° C	Midwest Labs

^a NCR - Recommended Chemical Soil Test Procedures for the North Central Region. No. 499 (revised). North Dakota State University. ^b RMST - Handbook on Reference Methods for Soil Testing, 1974, Council on Soil Testing and Plant Analysis. ^c ASA - Methods of Soil Analysis - Part 2: Chemical and Microbiological Properties, Second Edition, 1982. American Society of Agronomy. ^d USDA - USDA Agriculture Handbook 60

3.2.2 Results and Discussion

Vegetation Monitoring. The results of the vegetative monitoring included three criteria that were monitored: 1) Image J analysis for general green vegetation density based on photography; 2) plant height; and 3) types of plants. Figure 3.1 shows the change of percent “green” in each test cell on a bi-weekly then weekly basis. The trends of increasing and decreasing green in the image analysis of the cells can be explained by the wet and dry periods during the monitoring period and the physical attributes of the soils in which the vegetation were grown. The physical attributes of the soil media in each test cell will be explained later in this section. The blue dots in Figure 3.1 represent the rain events that occurred during the monitoring period that are listed in Table 2.5. For three of the four soil mixes, the 9 rain events between 4/28 and 6/27 (Fig. 3.1) contributed to the increase in green vegetation that occurred around 6/27. However, the soil mix of 33% Compost 66% Expanded Shale experienced a reduction of green color during this relatively wet period. The decline in green vegetation from 6/27 to 7/21 can be attributed to the 26 day dry period from 6/27 to 7/23. The second rise in green for the three cells appears to be the result of the 3 storms that occurred between 7/23 and 8/1.

It is important to note that the increases and decreases in percent “green” were affected by the growth and/or browning of both desired vegetation and weeds during the monitoring period. For example, the initial peaks in the graph on 5/24 could be due to the growth of the (undesired) weeds as per our observations. Figure 3.2 shows that the vegetation from the peak on 5/24 in the 33% Compost 66% Expanded Shale test cell is largely weeds; whereas, the peaks around 6/23 for the other cells could be due to green

slower growth of the planted (desired) grass species. For example, Figure 3.3 shows the 50% Compost and 50% Sand dominated by grasses and minimal weeds. The significant dip in green in the images for the 33% Compost 66% Expanded Shale test cell that occurred on 6/17 (Fig. 3.1) may be explained by browning of the Field pennycress (*Thlaspi arvense*) (Fig. 3.4). Furthermore, the decline in green in the images of the other three cells (Fig. 3.1) between 6/27 and 7/23, excluding the 33% Compost 66% Expanded Shale test cell, may be explained by the summer browning of the grasses present in the cells as there was no rain between 6/27 and 7/23. An example of this can be found in Figure 3.5. In comparison, the 33% Compost 66% Expanded Shale test cell had an increase in green during this dry period, which may be explained by the increase in weedy vegetation in Figure 3.6.

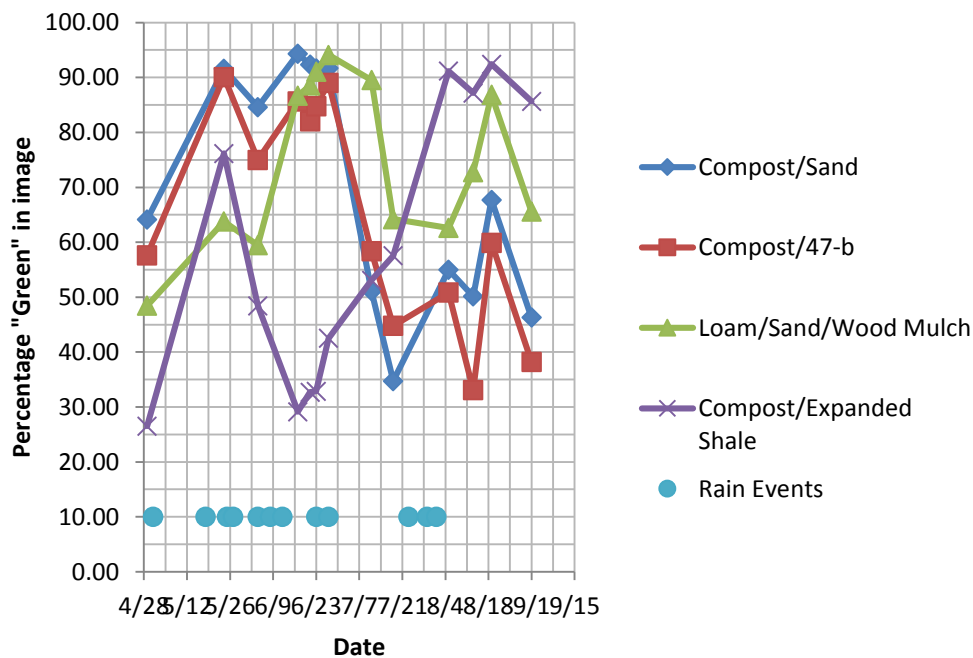

Figure 3.1 Average Percent “green” from north and south photographs in bioretention cells



Figure 3.2 Grasses in the cell of 33% Compost 66% Expanded Shale on 5/24



Figure 3.3 Grasses in the cell of 50% Compost 50% Sand on 6/17



Figure 3.4 Grasses in the cell of 33% Compost 66% Expanded Shale on 6/17



Figure 3.5 Grasses in the cell of 50% Compost 50% Sand on 7/18



Figure 3.6 Weeds in the cell of 33% Compost 66% Expanded Shale on 8/19

While it is difficult to determine which test cell had the best results based on image analysis results shown in Figure 3.1, the average and the standard deviation of all the percent green recorded for each cell may be used to better represent the general plant growth based on the image analysis. Table 3.5 shows the average results from the photographs taken looking south and north at the bioretention cells. The individual results from the north and south images can be found in Appendix B.

Table 3.5 Average Percent “green” from north and south photographs in bioretention cells

Date	Test plot media			
	50/50 compost/sand	40/60 compost/47-b	30/50/20 loam/sand/wood mulch	33/66 compost/expanded shale
4/29	64.15	57.64	48.45	26.53
5/24	91.58	90.08	63.78	76.17
6/4	84.62	74.99	59.47	48.43
6/17	94.30	85.67	86.67	29.13
6/21	92.35	82.03	88.55	32.70
6/23	91.68	84.79	91.06	32.86
6/27	91.69	89.01	94.12	42.50
7/11	51.11	58.36	89.54	53.08
7/18	34.74	44.80	64.22	57.55
8/5	54.98	50.86	62.62	91.16
8/13	50.13	33.06	72.78	87.17
8/19	67.71	59.90	86.86	92.42
9/1	46.30	38.22	65.58	85.65
Average	70.41	65.34	74.90	58.10
SD ¹	20.62	19.38	14.49	24.31
Rank ²	2	3	1	4

¹SD = standard deviation. ²Rank = the largest of Ave. + SD is ranked as #1.

Based on Table 3.5, the best media was the 30/50/20% Loam/Sand/Wood Mulch, and the worst media was the 33/66% Compost/Expanded Shale. The average and standard of deviation of the percent green represents the general ability of the vegetation to survive in green condition over longer periods of time. This is important because although bioretention is frequently inundated, the drought in summer months can be a more severe stress to vegetation because bioretention is designed to quickly drain water out of the system (Ming-Han et al. 2010). These results should be used with caution since results from these small sample size (n =1 for each soil mix) may be affected by random

weed infestations.

Vegetative Classification, Height and Count. In August 2013, samples of each of the plant species were collected, photographed, and classified by the NDOR research team (Table 3.6). Of the 25 plant species sampled by the UNL research team, 6 were species that were originally planted in July 2012. The other species found are other grasses and weeds.

Table 3.7 describes which bioretention cells had the originally planted species present upon inspection. During the species inspection no Blue grama, Oats/Wheat, Sand dropseed, or Buffalo grass were found. Based on Table 3.7 the best cells that supported plants seeded from the NDOR region B shoulder seed mix were 50/50% Compost/Sand and 40/60% Compost/47-b. Perennial ryegrass, Slender wheatgrass, and Western wheatgrass were found in the 50/50% Compost/Sand test cell and Western wheatgrass, Kentucky fescue, and Sideoats grama were found in the 40/60% Compost/47-b test cell. Only 2 planted species were found in test cell 30/50/20% Loam/Sand/Wood Mulch and no planted species were found in the 33/66% Compost/Expanded Shale test cell.

The results of the plant density (count) are shown in Table 3.8. The results show that the 33/66 compost/expanded shale test cell had the highest count of plants in a one foot square area. This result may not be a good representation of the vegetation results because the count consists entirely of unwanted weeds. The 50/50 compost/sand test cell had the lowest plant count although it had the best results from the image analysis monitoring. This may be because the image analysis results are based on the amount or density of green within the image taken in each test cell, while the plant count was taken

based on the physical number of plants counted at the base of the plant or ground. An example of this result would be tall dense grasses with thick upper foliage but less total number of root balls or clumps.

Table 3.6 Plant species sampled in bioretention cells for their classification

I.D. #**	Common Name	Scientific Name	Found in cell #***
1	Perennial ryegrass-Linn*	<i>Lolium perenne</i>	1
2	Field bindweed	<i>Convolvulus arvensis</i>	1
3	Field pennycress	<i>Thlaspi arvense</i>	1
4	Field bindweed	<i>Convolvulus arvensis</i>	1
5	Chicory	<i>Cichorium intybus</i>	1
6	Common ragweed	<i>Ambrosia artemisiifolia</i>	1
7	Spotted spurge	<i>Euphorbia maculata</i>	1
8	Common ragweed	<i>Ambrosia artemisiifolia</i>	2
9	Field pennycress	<i>Thlaspi arvense</i>	2
10	Kentucky fescue*	<i>Festuca arundinacea</i>	2
11	Western wheatgrass*	<i>Pascopyrum smithii</i>	1
12	Common ragweed	<i>Ambrosia artemisiifolia</i>	3
13	Slender wheatgrass*	<i>Elymus trachycaulum</i>	1
14	Crabgrass	<i>Digitaria sanguinalis</i>	3
15	Spotted spurge	<i>Euphorbia maculate</i>	3
16	Chicory	<i>Cichorium intybus</i>	4
17	Common ragweed	<i>Ambrosia artemisiifolia</i>	4
18	Prickly lettuce	<i>Lactuca serriola</i>	4
19	Prickly lettuce	<i>Lactuca serriola</i>	4
20	Hedge bindweed	<i>Calystegia sepium</i>	4
21	Yellow Foxtail	<i>Setaria pumila</i>	1
22	Windmill grass	<i>Chloris verticillata</i>	1
23	Sideoats grama-Trailway, Butte, El Reno*	<i>Bouteloua curtipendula</i>	2

1 = 50/50% Compost/Sand; 2 = 40/60% Compost/47-b; 3 = 30/50/20% Loam/Sand/Wood Mulch; 4 = 33/66% Compost/Expanded Shale. * Desired plants as shown in Table 3.2; ** The I.D. # is for reading convenience only; *** The plant was sampled from the cell but might also exist in other cells.

The results from the plant height measurements taken on the bioretention cells are shown in Table 3.9. All cells had maximum plant heights of around 50 inches except the 30/50/20 loam/sand/wood mulch. Three average height measurements were also taken of each test cell. The best results from the average height measurements were from the 50/50 compost/sand test cell which supports other vegetative results.

Table 3.7 Plant species found in bioretention cells that were planted in July 2012

Species Planted	Found in cell #
Perennial ryegrass-Linn	1
Slender wheatgrass	1,3
Western wheatgrass-Flintlock, Barton	1,2,3
Kentucky fescue	2
Blue grama-NE,KS,CO	Not found
Buffalograss-Cody,Bison,Sharp's Improved,Texoka	Not found
Sideoats grama-Trailway, Butte, El Reno	2
Sand dropseed (<i>Sporobolus cryptandrus</i>)	Not found
Oats/Wheat (wheat in the fall)	Not found

1 = 50/50% Compost/Sand; 2 = 40/60% Compost/47-b; 3 = 30/50/20% Loam/Sand/Wood Mulch; 4 = 33/66% Compost/Expanded Shale

Table 3.8 Bioretention cell plant density counts

1 ft² test square	50/50 compost/sand	40/60 compost/47-b	30/50/20 loam/ sand/wood mulch	33/66 compost/ expanded shale
Maximum density count	6	10	10	12
Minimum density count	1	8	6	9
Average density count	3	8	8	10

Soil Core Samples. The results from the soil core samples taken from the bioretention cells on 2/18/2013 can be found in Table 3.10. Table 3.10 also provides soil recommendations for crops from several different sources. Most soil recommendations found in Table 3.10 are based on recommendations for field crops such as corn or

soybeans. Most of these recommended concentrations are likely applicable to plant requirements in BMP medium design. Based on the results in Table 3.10, all of the bioretention cells had adequate levels of all soil properties tested to support optimum plant growth except for nitrate-N concentrations. As shown in Table 3.10, the phosphorus levels in all of the bioretention cells were reported as very high with the $P_1:P_2$ ratios of 1:1 and 1:2, which means that the P reserve is equal to the P_1 concentration and has a tight bond with the iron and aluminum in the soil (note d). The C:N ratio of all four bioretention cells was less than 20:1, which means the soil organic matter present will favor fast decomposition, resulting in quick release of nutrients. The use of the compost in BMPs could result in nutrient leaching from this fast release. Further investigation should be done on other types of organic matter with C:N ratios ranging from 20:1 to 30:1 for slower release of nutrients.

Table 3.9 Bioretention cell plant height (inches)

Measurement category	50/50 compost/sand	40/60 compost/47-b	30/50/20 loam/sand/wood mulch	33/66 compost/expanded shale
highest	50.13	53.25	36.25	53.06
measurement 1	37.63	30.00	19.47	20.09
measurement 2	37.88	29.00	19.34	20.03
measurement 3	37.25	29.81	18.97	19.94
Avg. of 1-3	38.59	29.60	19.26	20.02

Table 3.11 shows the comparison between primary nutrients from the results found in Table 3.10 and that reported in other BMP papers. All of the bioretention cells had higher than needed percent organic matter except the 30% loam 50% sand 20%

mulch test cell. Soil organic matter provides moisture holding capacity and nutrients for plants; more than the recommended amount is good unless leaching becomes a concern.

Table 3.10 Results from bioretention soil core samples with field crop recommendations

Property Sampled	50% compost 50% sand	40% compost 60% 47-B	30% loam 50% sand 20% mulch	33% compost 66% expanded shale	Optimum range for crops
Moisture Content %	20.66	13.7	16.08	46.33	N/A
% Organic Matter	5.2	5.2	2.2	26.6	4-6 ^b
Phosphorus ₁ ppm	131 VH	133 VH	57 L	128 VH	20-30 adequate for most crops ^a
Phosphorus ₂ ppm	141 VH	139 VH	117 VH	131 VH	40-60 desired for good crop yields ^a
P ₁ :P ₂ ratio	1:1	1:1	1:2	1:1	See note d
Potassium ppm	382	207	236	430	150-175 for coarse textured soils ^a
Magnesium ppm	329	255	182	521	100-250 ^a
Calcium ppm	2834	2926	2519	4424	Calcium deficiencies rare in soils with adequate pH ^a
Sodium ppm	36	21	56	162	N/A
pH	7.9	7.7	8	7.7	5.5-6.9 ^a
C.E.C meq/100g	18	17.4	15	28.3	5-35 typical ^a
Percent Base Saturation					
% Potassium	5.4	3.1	4	3.9	2-5 optimum crop performance ^a
% Magnesium	15.2	12.2	10.1	15.3	12-18 optimum crop performance ^a >23 exhibit drainage and compaction problems ^a
% Calcium	78.5	84.2	84.3	78.3	65-75 optimum crop performance ^a
% Hydrogen	0	0	0	0	N/A
% Sodium	0.9	0.5	1.6	2.5	>2.5 adverse effects ^a
Nitrate-N ppm	3	2	1	4	20-25 for crops ^c
Soluble salts mmhos/cm	0.4	0.2	0.3	0.5	< 1 negligible ^a ; > 1 affect salt sensitive plants ^a ; > 2 may require salt tolerant plants ^a
Total Carbon %	3.99	4.86	2.01	18.17	N/A
Total Nitrogen %	0.4	0.48	0.14	1.83	N/A
C/N ratio	10.1:1	10.1:1	14.9:1	9.9:1	See note e
^a measured and referenced by Midwest laboratories. ^b (Manjula 2010). ^c (Heckman 2003). ^d P ₁ :P ₂ Ratio comments: i) P ₁ = (weak bray) which represents the phosphorus readily available to plants; P ₂ = (strong bray) which represents the phosphorus readily available to plants plus a part of the active reserve in the soil; ii) 1:1 – M to VH low reserve. Fe and Al “P” bond is very tight – a lime application will release P and increases the Ca availability, generally the ratio will widen as a result of lime application; and iii) 1:2 with P ₁ M to H. Ideal range with reserve as high as the P ₁ availability reference by (Midwest laboratories). ^e Soil Organic Matter (SOM) C:N ratio comments: i) C:N < 20:1 favors fast decomposition resulting in quick release of nutrients; ii) C:N between 20:1 and 30:1 results in release of nutrients, but the decomposition is slow enough not to have excess nutrients released at the expense of the amount of SOM being added to the soil; and iii) C:N > 30:1 is an indication that the material is composed of difficult-to-break carbonaceous materials such as cellulose, hemicellulose, and lignin. High C:N ratio organic materials tend to stay on the surface of the soil or in the soil for a very long time. (Girma et al.)					

From the literature reviewed it was found that the amount of Phosphorus was found in excessive amounts in all of the bioretention cells, which is a leaching concern. Two recommended concentrations for P in bioretention soils are 50 ppm P (USEPA 1999) and 7-21 ppm P (Virginia DCR 2011). 7 to 21 ppm P is recommended based on a soil P index of 10-30. The soil P-Index (or Phosphorus Index) is the measure of phosphorus already present in soil. Values greater than 100 are considered very high. Values ranging between 50 and 100 are considered high. Values between 25 and 50 are medium; values less than 25 are low. A soil with a high P-Index is less able to retain phosphorus because it is already “full” (Hunt 2004). Table 3.12 shows a summary of the results from Hunt (2004), which supports the recommendation of a soil P index of 10-30 (7-21 ppm) to prevent P leaching and support P removal. The results from all of the four bioretention cells were 3 to 6 times higher than this recommended P concentration.

Based on the recommended value for Potassium (42.5 ppm) and Magnesium (17.5 ppm) from the USEPA (1999), the K and Mg values found in our bioretention cells were around 7 times higher for K and around 18 times higher for Mg. The pH values from the cells ranged from 7.7 to 8. The recommended value for pH from the USEPA (1999) is 5.5-6.5; within this pH range, pollutants (e.g., organic nitrogen and phosphorus) can be adsorbed by the soil, and microbial activity can flourish (USEPA 1999). The Cation Exchange Coefficient (CEC) found in our bioretention cells was above the recommended minimum of 10 meq/100g. Soils with a higher CEC value can treat pollutants better, with the primary source of CEC from clays and organic matter (Virginia DCR 2011).

Based on the comparisons of the testing results and recommended values, it could be concluded that too much compost was added to the cells. Based on Table 3.13 the composition of the compost (LinGro) used in the cells affected the organic matter, C:N ratio, pH, conductivity, and moisture content. Lowering the amount of compost in the BMP media could reduce the chance of phosphorus leaching, and decrease the pH. The addition of other organic matter such as mulch or wood chips could raise the C:N ratio, reducing the chance of leaching and providing a longer lasting source of nutrients for the vegetation present.

Table 3.11 Results from bioretention soil core samples with recommendations

Property Sampled	50% compost 50% sand	40% compost 60% 47-B	30% loam 50% sand 20% mulch	33% compost 66% expanded shale	Recommended for bioretention
% Organic Matter	5.2	5.2	2.2	26.6	^a 1.5-3
Phosphorus ₁ ppm ^b	131 VH ^d	133 VH	57 L ^d	128 VH	Note c
Phosphorus ₂ ppm ^b	141 VH	139 VH	117 VH	131 VH	Note c
P ₁ :P ₂ ratio	1:1	1:1	1:2	1:1	Note c
Potassium ppm	382	207	236	430	^a 42.5 max
Magnesium ppm	329	255	182	521	^a 17.5 max
pH	7.9	7.7	8	7.7	^a 5.5-6.5
C.E.C meq/100g	18	17.4	15	28.3	^c C.E.C>10

^a(USEPA 1999). ^bPhosphorus₁ = Bray 1 (plant available P) and Phosphorus₂ = Bray 1 (plant available P + fixed P). ^cHunt (2004) and Virginia DCR (2011). ^e 50 ppm (USEPA 1999), P index of 10-30 or 7-21 ppm (Virginia DCR 2011). ^dVH = very high; L = low.

Percolation Test. Table 3.14 shows the results from the percolation tests done on August 18, 2013 for all four bioretention cells. The design criterion used when the bioretention cells were built was a 24 hour drawdown time of the 9 inch ponding depth. With this specification a minimum percolation rate of 0.375 in/h is required. The lowest

percolation rate (40 in/h) shown in Table 3.14 is over 100 times faster than the minimum required drawdown rate. Other literature specifies minimum infiltration rates of 1 in/h and 0.5 in/h (ISMM 2008; USEPA1999). It should be noted that there is a slight difference between the percolation test and the field drawdown value because the percolation test involves digging of a test hole, which allows infiltration via both bottom and sidewall soils, while the field drawdown mainly occurs in one dimension.

Table 3.12 Summary of research findings on bioretention efficiency from Hunt (2004)

Cell (Study Period)	Soil P-Index	TN Removal	TP Removal	Other Findings
Greensboro–cell 1 (2002-2004)	86 – 100	40% - year 1 33% - year 2-3	240% increase – yr 1* 39% increase – yr 2-3	Cu and Zn reduced 65 to 99%
Greensboro–cell 2 (2003-2004)	35 – 50	43% - year 2-3	9% - year 2-3	Cu and Zn reduced 56 to 86%
Chapel Hill (2002-2003)	4 – 12	40%	65%	
Louisburg – cell 1 (2004-2005)	1 – 2	64%	66%	Higher inflow [TP]= higher TP removal
Louisburg – cell 2 (2004-2005)	1 – 2	68%	22%	Low inflow [TP] = lower TP removal
Charlotte (2004-2005)	7 – 14	65%	68%	Fecal coliform removal > 90%

* Net leaching of P from the soil.

Table 3.13 Properties of two composts used in engineered soil mixtures compared to LinGro

Property	LinGro	WRAEC compost ¹	WDNR standard ²
Organic matter	27.76%	35% –75%	≥ 40%
C:N	10.6:1	< 25:1	10–20:1
pH	8.1	6.5–8	6–8
Conductivity	5.75 mS/cm	NA	≤10 mhos x 10 ⁻⁵ cm ⁻¹
Moisture content	44.67%	30% –55%	35% –50%

¹ WRA Environmental Consultants (2009) and Thompson et al. (2008). ² Thompson et al. (2008).

Table 3.14 Bioretention percolation test results

Bioretention Cell	Percolation Rate (in/hr)
50% compost 50% sand	40
40% compost 60% 47-B	1,252
30% loam 50% sand 20% mulch	116
33% compost 66% expanded shale	1,047

The percolation rates shown in Table 3.14 were found to have some correlation with the vegetative and image analysis results. Based on the image J analysis, the 30% loam 50% sand 20% mulch mix and the 50% compost 50% sand mix had the best results for plant green intensity. These two cells also have the lower percolation rates of the four cells. Part of the ability of these media to support vegetation may be because the media infiltrate water more slowly, making water available for plant uptake longer. In contrast, the 33% compost 66% expanded shale test cell had the worst image J results and is the one with the highest percolation rate. The mixtures with the slower infiltration rates also had the best results for the vegetative species counting (Table 3.7), with the 50% compost 50% sand mix and the 30% loam 50% sand 20% mulch mix having better results than the 33% compost 66% expanded shale test cell.

TSS Grab Samples. The results from the TSS samples collected at the influent to the bioretention cells had an average TSS concentration of 27.7 mg/l with a standard of deviation of ± 24.58 mg/l. Such low TSS concentrations in the influent of the bioretention influent could be because the watershed is well stabilized, and the flows leading up to the sampling point flowed over about 100 ft of well-maintained grass ditch. In Figure 3.7 the TSS values from all sampling events are plotted against the HEC-HMS simulated flows

at the bioretention sampling location. The results in Figure 3.7 show little to no correlation between TSS and flow rates. This may be because of the grass ditch and stabilized watershed.

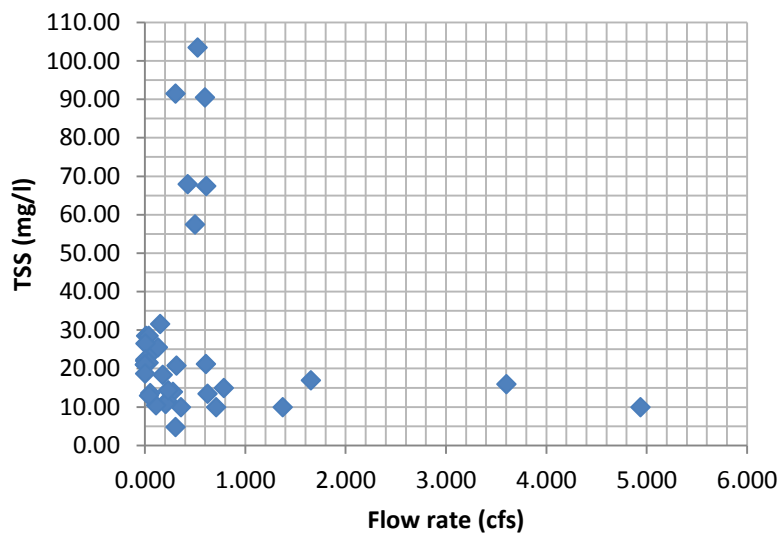

Figure 3.7 Bioretention cell influent TSS vs. flow rate

3.2.3 Summary of Bioretention Test Cell Study

For the bioretention cells, the medium can be ranked from best to poorest, based on soil properties and vegetative monitoring, as the 30/50/20% Loam/Sand/Wood Mulch, the 50/50% Compost/Sand, the 40/60% Compost/47-b and the 33/66% Compost/Expanded Shale. Results suggest that more than enough compost was used in all cells. The suggested correction for this finding would be to reduce the amount of compost blended in the mixtures and/or implementing soil media in layers with more compost in the top of the cell near the root zone with filtering media in the lower zones.

The influent TSS concentrations of the bioretention cells were low, which could be due to the vegetated grass ditch leading up to the cells.

3.3 Infiltration Trench

3.3.1 Methods and Materials

Observation Well Drawdown Time. To achieve a better understanding of the infiltration rate within the infiltration trench, the depth of water in the trench was monitored through time after a rain event. To monitor the infiltration rate depth, measurements were taken at the upstream observation well from the top of the observation well down to the water level. This measurement was then subtracted from the total depth of the observation well pipe to determine the water depth. Initially, measurements were taken at different hours after the end of a storm event i.e. (6, 12, 24 h, etc.). During this initial monitoring, minimal change was found in the water depth over short periods of time. With these initial findings, the monitoring scheme was changed to weekly or bi-weekly measurements.

Basket Rocks. To monitor the amount of sediments that the infiltration trench intercepted over the monitoring period, a method was developed to measure the Total Solids (TS) that accumulated within the 1 to 3 inch rock in the trench. To do this, golf ball baskets filled with 1 to 3 inch rock were buried level with the surface at 2 locations in the trench (Figure 3.8). The two locations of the baskets were in the upstream and downstream section of the trench. The golf ball baskets with a 100 ball capacity (0.004065 m^3) were acquired at a local sporting goods store. The inter-stone volume in

the basket was 0.002905 m^3 , resulting in a bulk porosity of $0.285 \text{ m}^3/\text{m}^3$. The baskets were deployed on 4/20/13 and were collected on 6/20/13, and then deployed again on 4/21/13 and collected on 8/9/13. The collection and extraction process involved taking the baskets back to the lab where the rocks were washed with 2 liters of de-ionized water and rubbed with a brush. The 2 liters of washing water was then evaporated at 105° C in an oven and the mass of the residue was determined.



Figure 3.8 Upstream infiltration trench basket rock and observation well

3.3.2 Results

Observation Well Drawdown Time. The results from the observation of the infiltration trench drawdown time are shown in Figure 3.9 along with the rain event dates. From the observation period between April and June, one of the initial findings was that the infiltration trench drawdown time is longer than the design time of 24 to 48 hours. The design time of 24 to 48 hours is set so that the BMP can be empty before the next storm to capture the new water quality volume. Also, the drawdown design time is used

to prevent long term ponding and hazards for motor vehicles. The longest dry time between rain events was 24 days (between June 27 and July 23). Emptying of the trench did not occur until 7/11/13, which could be because of the presence of subsoil moisture during the spring and the frequency of the spring rains. Summer rain events were farther apart and subsoil moisture is at a lower level during the summer than in the spring. In addition, the soil beneath the infiltration trench is silty clay loam, so a slow infiltration at this site is expected (web soil survey). Lastly, the trench at the observation wells was never completely full. This may be because the trench is located on a 2.8% slope which would prevent the trench from filling completely at the observation well locations which were about one third upstream and downstream from the end and beginning of the trench.

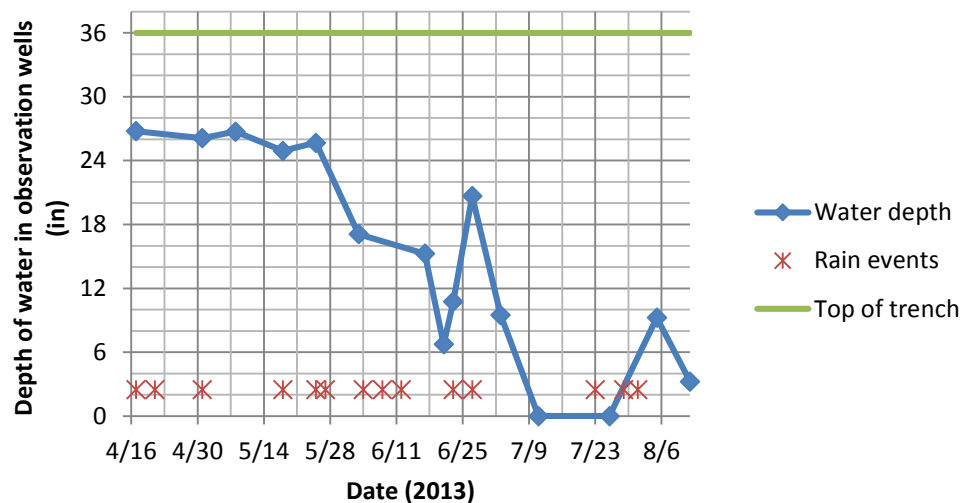

Figure 3.9 Observation well water depths as a function of time (in 2013) and rain events. The trench is 36 in deep with 0 being the bottom. All rain events shown are over 0.1 in. depth. No infiltration rates are reported as the data collection interval was on a weekly or bi-weekly basis

Basket Rocks. The results from the upstream and downstream basket rock collection are shown in Table 3.15. The total solids analysis results show that 1,508 to 2,878 g TS /m³ of bulk volume was intercepted in the infiltration trench during the deployment periods. Results of our basket rock studies can be used to estimate the life span of the infiltration trench (see Ch. 4).

Table 3.15 Total solids interception results for the infiltration trench

Deployment period	TS in basket (g)		TS in trench (g/m ³ of bulk volume)		Rain depth during period (in)
	upstream	downstream	upstream	downstream	
4/20-6/20	8.75	6.64	2,153	1,633	9.98
6/21-8/9	6.13	11.70	1,508	2,878	3.38

3.3.3 Summary

In general, the infiltration trench functioned as expected with minor sediment buildup on the top of the trench in a small portion of the trench. The basket rock results showed minor interception of TS, and the observation wells showed little drawdown in the spring with high subsoil moisture and more frequent rain events, indicating that the trench may not be able to capture and drawdown the WQV fast enough between rain events during the spring.

3.4 Filter Trench

3.4.1 Methods and Materials

Side Slope Collector. To achieve a better understanding of the amount and sources of sediments or Total Suspended Solids (TSS) that were entering the filter trench,

a device was designed as per Ming-Han et al. (2010) and built to monitor the TSS loading from the side slope of the filter trench (Figure 3.10). A 10 ft by 10 ft area of the side slope was sectioned by a board (1) on the uphill slope, and a 6-inch PVC pipe (2) with a collection slot cut into it on the downhill slope. Once water and sediment collected in the 6 inch pipe (2) it traveled through 1- inch tubing (3) to two covered five gallon buckets (4) for collection. The buckets were collected after each or multiple storm events and taken back to the lab for TSS testing per EPA method 2540 D. Figure 3.11 shows the rain events and dates for sampling side slope TSS.



Figure 3.10 Filter trench side slope TSS collector setup

TSS grab samples. As shown in Table 2.5 in Chapter 2, seven storms were sampled for TSS using grab sample methods. One of the grab sample locations was the influent of the filter trench. Grab samples were collected by the research team at the beginning of the storm when possible. Some sampling events were missed due to

thunderstorms with the safety of the sampling team in mind. The sampling procedure (rinsing the sample bottle twice then filling it) was initiated once enough flow was observed to complete the procedure within a 15 minute time frame. After the first sample was collected, the following samples were taken approximately every 15 minutes. All samples were collected in 1-L Nalgene bottles. After collection, sample bottles were preserved with ice and taken back to the lab for TSS analysis. All TSS analysis followed EPA method 2540 D.

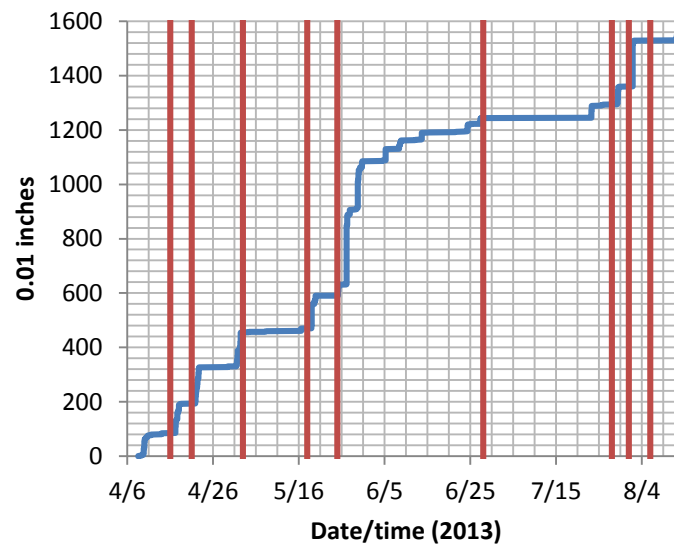

Figure 3.11 Rain Gauge data with side slope collection dates shown as vertical lines

3.4.2 Results and Discussion

Side Slope Collector. The side slope of the filter trench yielded high TSS values ranging from 524 to 5,490 mg/l with an average of 2,146 mg/L and a standard deviation of 1,908 mg/l (Table 3.16). Correlation of TSS vs. time, rain depth, and vegetation cover

were all checked. No strong correlations were found, with the correlation of time being the strongest with a R^2 of 0.425 (Figure 3.12). It is hypothesized that the TSS decreased over time due to ground cover although vegetative image analysis did not support this finding because the image analysis was based on green vegetation. An explanation of the lack of correlation to rain depth could be because of different antecedent dry periods, collection of some samples being from more than one rain event and variations of rain intensity for different rain events.

Table 3.16 Side slope TSS concentrations

Date collected	TSS mg/l
4/16/2013	2,493
4/21/2013	5,490
5/3/2013	1,250
5/18/2013	5,620
5/25/2013	1,284
6/28/2013	1,420
7/28/2013	598
8/1/2013	634
8/6/2013	524
Average	2,146
Std. dev.	1,908

TSS Grab Samples. The results from the TSS samples collected at the influent and effluent location of the filter trench had an average TSS concentration of 98.88 mg/l and 137.48 mg/l with a standard deviation of ± 38.83 mg/l and ± 113.04 mg/l, respectively. The higher values of effluent TSS compared to the influent TSS may be due to the contribution of TSS from the side slope as well as scouring within the trench. In

Figures 3.13 and 3.14 the TSS values from all sampling events are plotted against the HEC-HMS simulated flows at the influent and effluent sampling locations; the results show little to no correlation between TSS and flow rates.

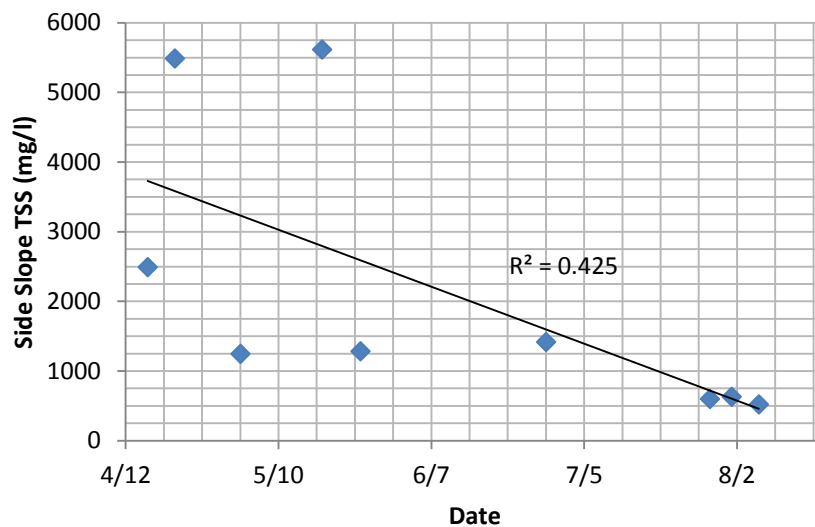

Figure 3.12 Side Slope TSS vs. time

The TSS of the influent and effluent of the filter trench was also sampled to test the removal efficiency of the BMP. Figure 3.15 shows the TSS percent removal of all of the 15 minute grab samples. To calculate these percent removals, TSS grab sample values of the influent and effluent at the same timestamp were used. This method was used because the filter's lag time (for the influent to be shown in the effluent) was essentially unknown. The TSS percent removal ranged from -275 to about 75%, with negative representing leaching or a net increase in TSS in the effluent. Over time the percent removal of TSS increased. This may be because of the side slopes of the filter trench becoming more

vegetated and sediments that were present in the filter trench media before the extended monitoring period having been washed out.

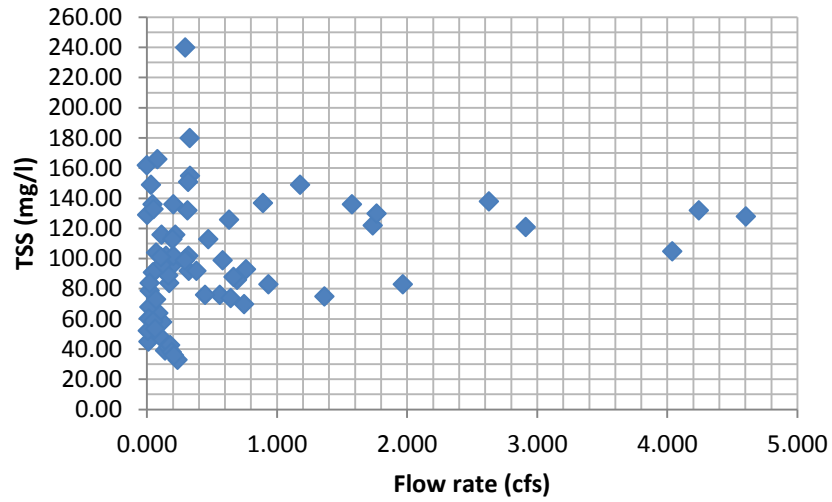

Figure 3.13 Filter trench influent TSS vs. flow rate

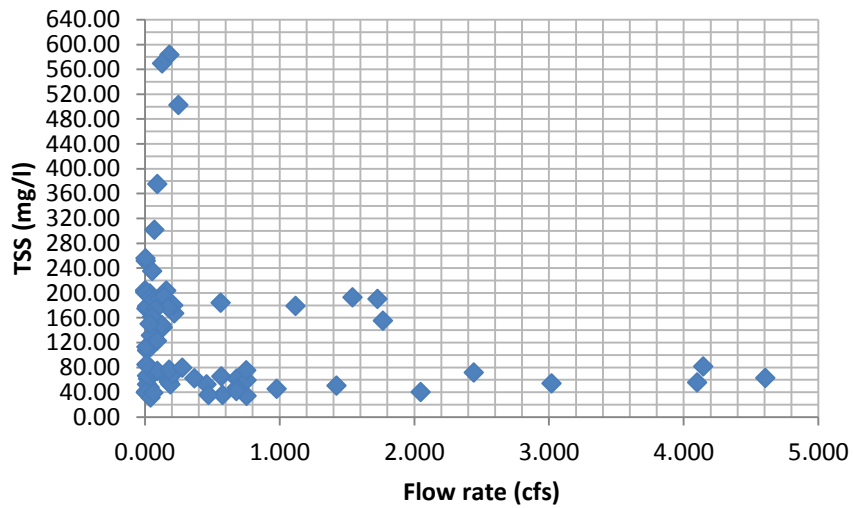

Figure 3.14 Filter trench effluent TSS vs. flow rate

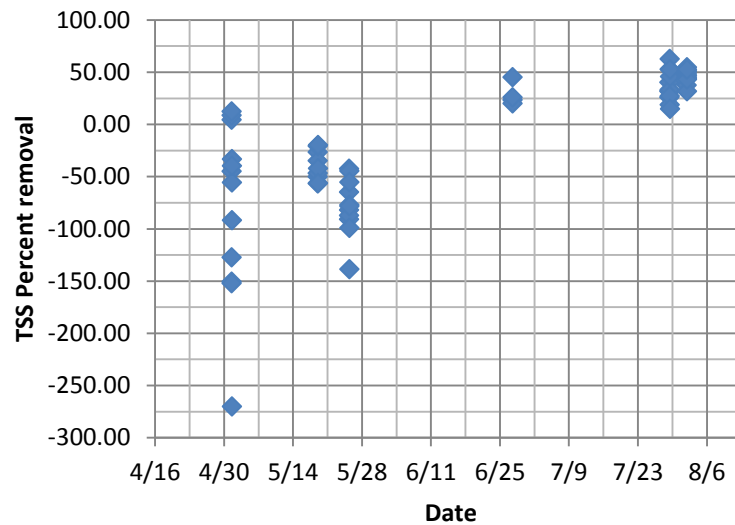

Figure 3.15 Filter trench TSS percent removal

3.4.3 Summary

The filter trench monitoring resulted in little correlation of TSS to vegetation and hydrologic variables. The side slope data showed an average of 2,146 mg/l of TSS contributed to the loading of the filter trench BMP. In contrast, the grab samples average TSS was 98.88 mg/l. Therefore, more TSS loading was coming from the immediate areas that are poorly vegetated around the BMP. Due to the issues caused by the poor vegetation some design and construction the following recommendations can be made: 1) maintain low disturbance of surrounding area during BMP construction, 2) part of BMP design should include seeding and long term vegetation establishment and 3) good quality vegetation surrounding the BMP can improve the effectiveness and lifespan of the BMP.

3.5 Check Dam Filters

3.5.1 Methods and Materials

Basket Rocks. To monitor the amount of sediments that the check dam filters intercepted over the monitoring period, a method was developed to measure the Total Solids (TS) that adhered to the 47-b gravel located in the check dam filters. Four baskets filled with 47-b media were deployed in the ponding area of the four check dam filters (one basket per check dam) (Figure 3.16). The basket media (47-b) was washed with De-ionized (DI) water over #270 sieve three times prior to deployment. Then the cleaned media was dried and placed in the four baskets. The baskets were 6" by 6" by 6" and made of the black nylon pet resistant screen with the outside made of a steel basket made of ¼ inch square galvanized metal mesh. After the deployment period (7/11 to 10/2) the baskets were taken to the lab for analysis. In the lab the sand from each basket was washed with 2 L of DI water over # 270 sieve, and the washed water was collected into 2 L beakers. The 2 L beakers were then oven-dried at 105°C to measure total solids passing the #270 sieve. After all beakers were dried out, the mass of each beaker was measured, and the mass difference between the empty beaker and the dried out beaker was the amount of total solids passing the #270 sieve found in the corresponding basket.

Percolation Test. A percolation test was performed on 7/1/13 as part of the site assessment visit at the I-street project site. The methods followed for this test are described by Crites and Tchobanoglous (1998). The test location was located in the center of each check dam filter's ponding area with the test hole being 4 inches in

diameter by 15 inches deep. Water was added until the test hole accumulated 6 inches of water; then the time for the water to totally drain away was recorded.



Figure 3.16 47-b media sediment collection basket deployed at I street

Total Solids Tests. As shown in Figure. 3.17, check dams were covered by sediments after their construction. To analyze how much sediments or fines have been intercepted by the 47-b media material up to the site visit that occurred on 7/11/13, check dam media between 0 and 12 inches were collected during the site assessment visit on 7/11/13 at the I-street project site. In addition, surface samples from the ponding area were collected, and baskets of 47-b material were deployed for sediment interception monitoring for later collection.

The media and surface samples were washed with de-ionized water in a #270 sieve. The washing water was collected in 2 liter beakers and dried at 105°C and massed. The difference in the final and initial mass of the beaker was the total solids present in the media passing the #270 sieve. Samples were washed over a #270 sieve because a portion

of the 47-b media is too small to separate from silt sand and clay. Specifically the #270 sieve was used so that the total solids captured only included clay and silt based on Figure 3.18. It is important to know the texture differences between the top sediment and the media below the sediment layer. Texture analysis was performed on all surface samples collected as well as a site soil sample and a composite sample of all total solids passing the #270 sieve from the solids tests. These texture analyses were done at Midwest Laboratories per their referenced hydrometer texture analysis method.

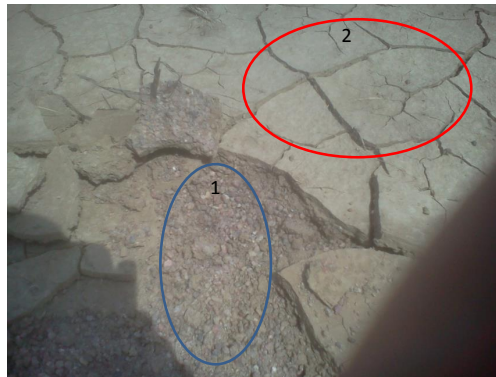

Figure 3.17 Check dam filter gravel (blue circle) and surface sediment (red circle)

Flow-through Tests. The saturated hydraulic conductivity of the gravel installed and the site soil at I street was measured with a method based on the ASTM D2434 standard and flow-through testing method (Thompson et al. 2008). The saturated hydraulic conductivity procedure consisted of a consistent inflow and outflow rate with 9 inches of head above the soil media held constant. Tap water was run through a hose to the top of the reactor, and ponding was allowed up to an overflow port. Once steady flow

from the effluent and overflow port were observed for a period of 15-30 min., effluent volumes were measured with a graduated cylinder for a given time period (e.g., 900 mL/30 s). Three readings were taken to check consistency.

		PARTICLE SIZE LIMIT CLASSIFICATION			
		USDA	CSSC	ISSS	ASTM (UNIFIED)
PARTICLE SIZE (mm)	0.0002	CLAY	FINE CLAY	CLAY	FINES (SILT AND CLAY)
	0.001		COARSE CLAY		
	0.002	SILT	FINE SILT	SILT	
	0.003		MEDIUM SILT		
	0.004				
	0.006	VERY FINE SAND	VERY FINE SAND	FINE SAND	
	0.008				
	0.01				
	0.02	FINE SAND	FINE SAND	FINE SAND	
	0.03				
	0.04	MEDIUM SAND	MEDIUM SAND	COARSE SAND	
	0.06				
	0.06				
	0.08	COARSE SAND	COARSE SAND	COARSE SAND	
0.1					
0.1	VERY COARSE SAND	VERY COARSE SAND	COARSE SAND		
0.2					
0.2	FINE GRAVEL	GRAVEL	GRAVEL		
0.3					
0.3	COARSE GRAVEL	GRAVEL	GRAVEL		
0.4					
0.6	COARSE GRAVEL	GRAVEL	GRAVEL		
0.8					
0.8	COARSE GRAVEL	GRAVEL	GRAVEL		
1.0					
1.0	COARSE GRAVEL	GRAVEL	GRAVEL		
2.0					
2.0	COARSE GRAVEL	GRAVEL	GRAVEL		
3.0					
3.0	COARSE GRAVEL	GRAVEL	GRAVEL		
4.0					
4.0	COARSE GRAVEL	GRAVEL	GRAVEL		
6.0					
6.0	COARSE GRAVEL	GRAVEL	GRAVEL		
8.0					
8.0	COARSE GRAVEL	GRAVEL	GRAVEL		
10					
10	COARSE GRAVEL	GRAVEL	GRAVEL		
20					
20	COARSE GRAVEL	GRAVEL	GRAVEL		
30					
30	COARSE GRAVEL	GRAVEL	GRAVEL		
40					
40	COARSE GRAVEL	GRAVEL	GRAVEL		
60					
60	COARSE GRAVEL	GRAVEL	GRAVEL		
80					
80	COBBLES	COBBLES	COBBLES	COBBLES	

Figure 3.18 Particle-size limits as per classification schemes of i) USDA, U.S. Department of Agriculture; ii) CSSC, Canada Soil Survey Committee; iii) ISSS International Soil Sci. Soc.; and iv) ASTM American Society for Testing and Materials (Jones and Benton 2001)

Saturated hydraulic conductivity was calculated using equation 3-1.

$$K_{\text{sat}} = \frac{Q \cdot L}{A \cdot t \cdot h}$$

3-1

where:

K_{sat} : Saturated hydraulic conductivity (cm/s)

Q: Volume of water passed through column (cm³)

L: Length of soil media (cm) = 45.72cm

A: Cross sectional area of column (cm²) = 45.6cm²

t: Time for Q to pass through the column (s)

h: Height of water column plus soil media (cm) = 68.58cm

HEC-HMS Modeling. During the monitoring period no storms were observed to create ponding behind any of the check dams. Therefore, a hydrologic model (i.e., HEC-HMS model) of the I-Street site watershed was constructed to predict how much precipitation was needed to generate enough direct runoff for ponding to occur. Before developing the model, the basic geologic and hydrologic characteristics of the watershed were quantified. Based on the site visit observation, it was determined that the I-Street site watershed is composed of two land types: grass and concrete. The areas of the two land types were obtained by the area tool measurement in the Google Earth computer program (Table 3.17). For the loss method, the SCS curve method was used because this is a widely used method developed on small watersheds in the Midwest. The composite curve number chosen was 75.58 (Gupta, 2008). The lag time was calculated as 5 minutes, and the base

flow was set to 0 cfs. To determine the depth of rain required to create ponding at the check dams, the SCS type II distribution 24 h synthetic storm was used. Different rain depths were tested with the resulting depth of rain being based on the direct runoff of 0.01 cfs.

Table 3.17 Land types within the I-Street check dam filters watershed

Land types area (mi ² or acre)		
Impervious	Grass	Total
0.000750 or 0.48	0.003016 or 1.93	0.003766 or 2.41
19.91%	80.08%	100.00%

3.5.2 Results and Discussion

Basket Rocks. The results from the 47-b media baskets that were deployed in the check dam filter from 7/11/13 to 10/2/13 are shown in Table 3.18. The mass of sediments collected was primarily located on the top of the media in the baskets that were deployed. Table 3.18 shows that all four check dams had similar masses of sediment. With similar masses in each of the series of check dams, we concluded that the source of the sediments was from the side slopes of the check dams rather than from an upstream sources.

Table 3.18 Mass of total solids passing #270 sieve found in 47-b media baskets

Check dam filter	Mass of TS passing #270 sieve (g)
1	35.60
2	38.12
3	36.34
4	37.21

Percolation Test. During the I-street site assessment visit on 7/11/13, percolation tests were done on all four ponding areas of the check dam filters. The results from these percolation tests can be found in Table 3.19. The results showed that the percolation rates in all four check dams are well above the minimum rate of 0.75 in/h to achieve a 24-h drawdown time of the 1.5' ponding area of each check dam filter.

Table 3.19 Percolation rate of I-street check dams

Check dam filter	Percolation rate of 47-b media (in/h)
1	981.6
2	831
3	393
4	526.8

Total Solids Tests. The TS of the surface and media samples are shown in Table 3.20. The objective of testing the soil at the surface and the 1-ft media was to find the depth of interception of sediments in the 47-b media. The results showed that on average there was 121.44 more grams of sediments per liter of bulk volume of tested material on the surface than 12 inches into the media. The significance of this finding is that the BMP can easily be mitigated if needed by cleaning and/or replacing the top layer of gravel.

As shown in Figure 3.17, check dams were covered by sediments after their construction. To analyze how much sediments or fines have been intercepted by the 47-b media material up to the site visit that occurred on 7/11/13, check dam media between 0 and 12 inches were collected during the site assessment visit on 7/11/13 at the I-street project site. In addition, surface samples from the ponding area were collected, and

baskets of 47-b material were deployed for sediment interception monitoring for later collection.

Table 3.20 Results from total solids testing of surface and 47-b media samples^a

Sample	TS passing #270 sieve (g)	Sample	TS passing #270 sieve (g)	Difference of the two samples' TS passing #270 sieve (g)	
S1	79.56	M1	17.66	S1 - M1 =	61.90
S2	207.37	M2	70.20	S2 - M2 =	137.17
S3	212.34	M3	69.58	S3 - M3 =	142.76
S4	203.14	M4	59.20	S4 - M4 =	143.94
Average	175.60	Average	54.16	Average	121.44
Stdev	55.55	Stdev	21.52	Stdev	34.47

^a for each sample, 1 liter bulk volume of the tested material used. S = Surface sample. # 1, 2, 3, and 4 indicate which check dam was sampled. M = media sampled from 0-12 inches below the surface.

To try and achieve a better understanding of the source of the sediments collected in the media, texture analysis was done on all surface samples, site soils samples, and a composite total solids sample. The motivation behind this was to see if the sediment source was the stormwater or the site soil that was disturbed around the BMP (e.g., after the construction of the BMPs). The results of the texture analysis can be found in Table 3.21. The texture results show a similarity in the surface samples (19.5, 66, and 14.5% for sand, silt and clay, respectively) and the site soil texture (20, 56, and 24% for sand, silt and clay, respectively), suggesting that the surface sediment were from the I-street soil immediately next to the check dams. In contrast, one could expect a different composition of sand, silt, and clay from storm water coming from the watershed or upstream of the check dams, i.e., more gravel and sands from the roadway.

Table 3.21 Texture analysis results from surface samples collected at I-street and a composite sample of the total solids passing the #270 sieve

Sample location	% sand	% silt	% clay
Surface sample of Check dam 1	20	64	16
Surface sample of Check dam 2	20	68	12
Surface sample of Check dam 3	14	70	16
Surface sample of Check dam 4	24	62	14
Surface sample of Check dam average	19.5	66	14.5
TS of composite sample ^a passing #270 sieve	10	78	12
I-street site soil (Silty Loam)	20	56	24

^a Composite sample was made from combining all TS that came off of all depth media samples.

Flow-through Tests. A sample of I street site soil and a sample of 47-b media that was washed over a #270 sieve were used for flow through testing (saturated hydraulic conductivity) to better understand the infiltration rate of the check dam filter media. If the clogging only occurs on the top 1 or 2 inches of the surface, the infiltration rate would be controlled by two different materials, i.e., the sediment in the top layer, and the media underneath of the sediment. Based on the results in Table 3.22, the clean 47-b media exhibited well above the minimum drawdown rate of 0.75 in/h for the check dam filters. With the added clogging layer, it would take 1.42 to 2.84 h for water to pass through the 1- or 2-in sediment (clogging) layer at a rate of 1.42 in/h. Water would still have about 21 h of the 24 h drawdown time to infiltrate through the media at a rate of 187.91 in/h as shown in Table 3.22. Therefore, the check dams could still function normally.

Table 3.22 Saturated hydraulic conductivity results from I-street tests

Sample media	K _{sat} (cm/s)	K _{sat} (in/h)
47-b gravel washed over #270 sieve	0.13258	187.91
I-street site soil (Silty Loam)	0.000999	1.42

K_{sat} = Saturated hydraulic conductivity.

HEC-HMS Modeling. The HEC-HMS hydrologic model was used to determine the required precipitation to generate direct runoff. Varying the storm depth at 0.01 inch increments, it was found that a storm depth of 0.78 inches would result in 0.01 inches of direct runoff. Although this depth of rain will initiate runoff, it may not directly correlate to ponding within the check dam filters. This could be because of the infiltration rates of the check dams and the infiltration rate of the ditch directly leading into the check dams.

3.5.3 Summary

Based on the results discussed in this section the check dam filters at the I-street project site location are still functional. The results from the percolation tests and the saturated hydraulic conductivity tests show the gravel layer (47-b medium) of the check dams still have a drawdown rate ranging from 187 to 981 in/h, even though the clay clogging layer (~1-2 inches thick) has a percolation rate of about 1.42 in/h. Total solids testing showed that the clogging was primarily located on the surface of the media which indicates if mitigation procedures are needed only the surface media needs replacing. Also, soil texture analysis of the site soil and total solids samples suggests that the source of the sediments is the disturbed soil around the BMPs which suggests more vegetation soil stabilization is required.

Chapter 4 BMP Lifespan and Feasibility

4.1 BMP Lifespan and TSS Mass Balance

To achieve a better understanding of the effects of TSS on the clogging process of the BMPs, calculations were done to find the time and rate at which the void space in the media within the BMP would fill with sediment. The calculations used rain gauge depth data, HEC-HMS flow rates, grab sample TSS values, and basket rock TS interception values. The rain depth was used to relate the sample collection period to the average annual rain depth to estimate the yearly TSS and TS loading rates (Table 4.1). The volume of stormwater that the TSS and TS samples represented was found by summing the 5 minute HEC-HMS flow rates at the respective grab sample site multiplied by the time step of 5 minutes. The volume of stormwater found was then multiplied by the average TSS or TS value and the ration of sample/annual rain to find the yearly loading mass of TSS and TS.

To find the estimated time until the BMPs void spaces would be fully clogged with sediment, the void volume of the media and the estimated average annual TSS or TS loading rate were used. Table 4.2 shows the dimensions of the BMPS and the volume of the void space. A void ratio of 0.4 was used for all of the BMPs. Table 4.3 shows the results from the calculation for the annual loading rate and the estimated time until the BMP would be fully clogged.

The results showed that all of the BMPs tested would require more than 100 years to be fully clogged based on the sample values and the methods used in the calculations. These results are not necessarily representative of a typical roadside situation due to the

high amount of grass area of the watershed (see Tables 2.1 and 2.2 about the watershed boundaries and land uses) compared to impervious area, resulting in lower TSS values. However, these results do support the use of pretreatment for stormwater BMPs. The time to fill voids shown in Table 4.3 may not represent the actual time to failure of the BMP. Figures 4.1 through 4.4 show the mass balance results for all of the BMPs tested. The influent TSS loading to the infiltration trench and the bioretention cells were the same because both BMPs shared the same source of stormwater. The bioretention cell mass balance incorporates other literature removal rate results, ranging from 65 to 100 percent TSS removal (PGCM 2007; Hatt et al. 2008; ISMM 2009). Results of both the infiltration trench and the check dam filter were based on TS interception data from baskets of media deployed in the BMPs.

Table 4.1 TSS and TS mass balance calculations

Locations related to BMPs	Rain depth sampled ¹ (in)	Avg. TSS value for rain depth during sampling period (mg/L) ²	Avg. yearly rain depth/ sampled rain depth	Average TS (g) ²	Represented volume of stormwater sampled (l) ³	Yearly TS (kg)	Yearly TSS (kg) ⁴
Side slope of filter trench	9.38	2146	3.02	N/A	997	N/A	322.86
Filter trench influent	6.53	98.9	4.33	N/A	1,070,333	N/A	458.36
filter trench effluent	6.53	137.5	4.33	N/A	1,070,333	N/A	637.25
I-street check dam filter	3.53	N/A	8.33	36.8	N/A	0.306	N/A
infiltration baskets	6.53	27.7	4.33	8.31	836,269	0.036	75.38
bioretention cells	6.53	27.7	4.33	N/A	836,269	N/A	75.38

Note: Average annual rain fall from Omaha and Lincoln, NE is 29.4" and 28.3" (NCDC 2012). ¹varied periods, sample time frame shown in rain event table in chapter 2. ²average values used are from results explained in chapter 3. ³volume found from HEC-HMS simulated flow rates at sample location on a 5 minute time step. ⁴calculation examples: $322.86 = 2146 * 3.02 * 997 * 49.97/10^6$ ($49.97 * 100 \text{ ft}^2 =$ total two-side side slope area); $458.36 = 98.9 * 4.33 * 1070333/10^6$; $8.31 = (8.75 + 6.64 + 6.13 + 11.70)/4$ (Table 3.15); and 27.7 is the TSS concentration of the influent to the bioretention cells and infiltration trench (see **TSS Grab Samples**, p. 37).

Table 4.2 Media dimensions for different BMPs tested

	Width (ft)	Depth (ft)	Length (ft)	Volume (ft ³)	Void space = 0.4*volume (ft ³ and m ³)
Infiltration trench	3	4	118	1416	565 and 16.0
Filter trench	3	4	250	3000	1200 and 34.0
Check dam filter media	6	3	20	360	145 and 4.1

Note: No results for bioretention cells because of no definition of failure due to clogging from void spaces

Table 4.3 Calculated BMP clogging lifespan based on filling of void space

	load per year (kg)	void space filled per year (m ³)	Time to fill voids (yr)
Filter	781.62 TSS	2.95E-01	115
Infiltration	8.85 TS/m ³ media	3.34E-03	4,803
Check dam	0.0011 TS/m ³ media	4.15E-07	9,823,355

Note: No results for bioretention cells because of no definition of failure due to clogging from void spaces

¹Loading used from figures 4.2,3,4 based on values from TSS and TS results from chapter 3

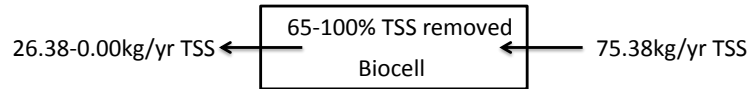

Figure 4.1 Yearly mass balance for TSS in the bioretention cells

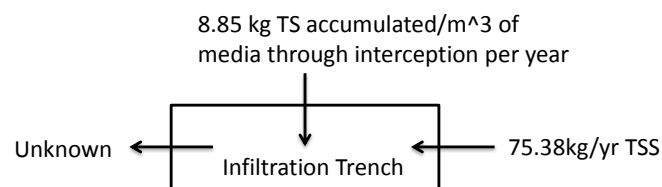

Figure 4.2 Yearly mass balance for TS accumulation in the infiltration trench

The annual side slope loading results at the filter trench found from the 10 ft x 10 ft test plot were applied to the full length of each side of the filter trench by assuming uniformly distributed loading from side slope erosion. The side slope erosion added another source of TSS in addition to the stormwater source at the beginning of the trench.

Grab sample TSS analysis and results from chapter 3 showed a negative 18% removal of TSS from the filter trench (negative removal meaning leaching or addition of TSS from the trench). The mass balance results shown in Figure 4.3 supports these results, that is, the addition of TSS from the 2 sources made it possible for the average annual TSS value found in the effluent to be about 20% higher than that from the beginning of the trench.

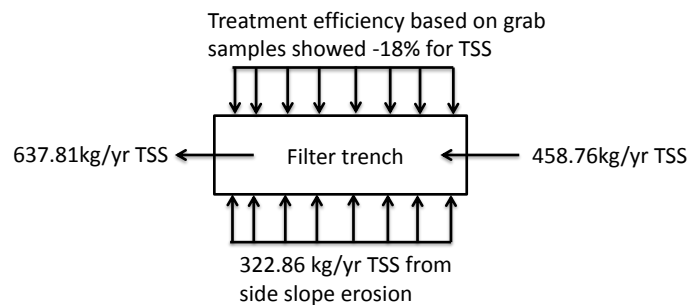

Figure 4.3 Yearly mass balance for TSS in the filter trench

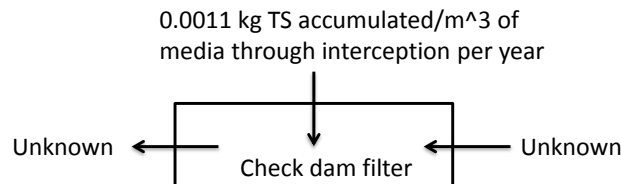

Figure 4.4 Yearly mass balance for TS accumulation in the check dam filter

Some limitations and assumptions were encountered when doing these mass balance calculations. The assumptions involved in these calculations included: filling of the entire void space without cake layer or surface clogging occurring; the TSS samples and flow rate data collected represented a typical year of rain events (i.e. depth and intensity); and no re-suspension of sediments trapped in the BMPs occurred. The primary

limitation of these calculations is that no cake layer develops or surface clogging occurs. Results from the site assessment of the I-street check dams showed that a majority of the sediment interception occurred after the first storm event, with the void space of approximately the top 6 inches of media being filled and a 1 to 2 inch layer of silt and clay accumulating on top of the media (Table 3.20). Considering uneven clogging would likely reduce the estimated lifetime significantly.

4.2 Feasibility of Full-scale BMPs

In this study, the feasibility of full-scale BMPs was judged on several criteria: price, applicability to the roadside, maintenance required, and clogging issues. Table 4.4 shows the estimated price breakdown based on several situations. As part of the design process, the BMP designer could choose the most cost effective BMP based on the price per WQV, per LF, or area of BMP with restrictions on the type based on site criteria and location. Tables 4.5 and 4.6 show the estimated material quantities and price breakdown of the BMPs tested in this project.

Table 4.4 Estimated price breakdown per BMP and WQV

	Total estimated material cost	Price per unit	Price per ft ³ of WQV treated	WQV test BMP was designed for (ft ³)
I-street check dams	\$2438.00	\$609.50 per check dam	\$2.47	987
Salt valley bioretention cells	\$1111.18	\$6.86 per ft ²	\$0.91	1,221
Salt valley filter trench	\$4509.49	\$18.04 per linear foot	\$5.01	900
Salt valley infiltration trench	\$2039.26	\$17.28 per LF	\$3.60	566

Note: The test bioretention cells treat 20% of the WQV; the test filter trench treats 25% of the WQV; the test infiltration trench treats 9% of the WQV; and the test check dams are able to treat more than the WQV (988 ft³).

Table 4.5 UNL team material price estimate and quantities for media material used in Fall 2011

BMP	1/4"-3/8" pea gravel (ft ³)	Sandy loam/ loamy sand (ft ³)	Oma- gro/ Lin gro compost (ft ³)	NDOR grout sand (ft ³)	NDOR 47-B (ft ³)	2x shredded hardwood mulch (ft ³)	3/4" gravel (ft ³)	1-3" clean stone (ft ³)	R4 rip-rap (ft ³)	Expanded shale (ft ³)
I-street Check Dams 3/4" gravel	0	0	0	0	0	0	1404	0	0	0
Bioretention cells										
1. 50% sand 50% compost	14	0	31	31	0	0	34	0	0	0
2. 40% compost 60% 47-B	14	0	25	0	37	0	34	0	0	0
3. 30% sandy loam/loamy sand 50% sand 20% 2x shredded hardwood mulch	14	19	0	31	0	13	34	0	0	0
4. 33% compost 66% expanded shale	0	0	21	0	0	0	0	0	0	41
Filter trench 1/4"-3/8" pea gravel with armoring and rip-rap	2625	0	0	0	0	0	0	375	270	0
Infiltration trench half 1-3" clean stone	0	0	0	0	0	0	0	1416	0	0
Totals (yd ³) (sum of all material type in ft ³ divided by 27)	98.78	0.70	2.85	2.30	1.37	0.48	55.78	66.33	10.00	1.52
Price per yd ³ Quoted cost fall of 2011 ¹	\$31.50	\$49.00	\$7.50	\$6.65	\$5.65	\$5.00	\$31.50	\$23.63	\$31.88	\$30
Total Price for each material type	\$3,111.50	\$34.48	\$21.39	\$15.27	\$7.74	\$2.41	\$1,757.00	\$1,567.46	\$318.80	\$45.56
¹ Prices from Mallard Sand and Gravel, Rip Rap-Martin and Maretta, and Compost-Oma-gro/Lin-gro									Total Cost	\$6,836.05

Table 4.6 UNL team material price estimate and quantities for material used in Fall 2011

Material	Quantity	Price per unit	Total price
Non-woven filter fabric with min. permittivity of 75/gal/min/ft ²	630'	\$595.00	\$1190.00
4" diameter PVC with 3/8" holes 6" O.C. 3 holes per row	64'	\$14.39	\$100.73
4" Diameter solid PVC	200'	\$14.39	\$287.80
4" diameter PVC caps	4	\$5.56	\$22.24
4" PVC 90 degree elbows	8	\$5.01	\$40.08
4" PVC 45 degree elbows	4	\$4.08	\$16.32
2"x12" weir board	40'	\$10.97	\$43.88
Erosion control blanket class 1-D	12,000 ft ²	\$0.12	\$1440.00
3' metal stakes	7	\$3.48	\$24.36
		Total cost	\$3,165.41

Note: Filter fabric and erosion blanket price from White Cap supplier all other material prices from local hardware store

Table 4.7 shows the material quantity and prices recorded during construction. Due to the building situation and timeline, minimal data was collected on man-hours and material quantities and prices, which are one reason why the recorded costs are about \$2,000 lower than the estimated ones. Another reason for the price difference in the estimate and actual is that some materials estimated were not used. The reasoning for this is because construction took place at the NDOR maintenance yard where bulk material storage is readily available. Also, some erosion control blanket was not used as noted in Part I of this project.

Table 4.7 Amount and price of materials purchased at salt valley project site

Material	Price per unit	Amount purchased	Total price
1-3" clean rock	\$13.20/ton	120.91	\$ 1,596.01
Washed pea gravel	\$29.00/ton	95.03	\$ 2,755.87
Filter fabric and ECB	N/A	N/A	\$ 452.06
			\$ 4,803.94

The number of BMP installations needed is hard to estimate based on the results of this project. In Part I of this report, a general design guideline for the four BMP tested in this project are described. The BMPs needed would be based on the WQV that needs to be treated and the roadside situations of these BMPs. Based on the major conclusions of Vacha (2012), vegetated filter strips are a viable option for pollutant removal. Therefore, existing roadside vegetation may already be acting as a BMP or may be easily retrofitted to do so (Vacha 2012). With this conclusion, other more compact BMPs may only be needed within ultra-urban areas as well-vegetated, already-established roadsides may not have enough capacity for treating roadside stormwater runoff. This “ultra-urban situation” would be roadside situations where distributed runoff is not being treated enough by the roadside vegetation or where outlet pipes are concentrating the polluted roadside runoff so that vegetated roadsides are unable to treat it. The findings from this report support the ability for well-vegetated areas to treat stormwater based on low TSS findings and lower flow findings at the inlet of the bioretention cells as well as little runoff volume experienced at the I-street location due to the large vegetated contributing area in the watershed.

Throughout the monitoring of this project, some operation and maintenance issues were observed. The primary observations in Phase I studies were sediment clogging of all of the BMPs to some extent except for the bioretention cells. However, during the period of Phase II, some sediment clogging became more stabilized or was re-suspended back into the runoff. Another result of this clogging during the period of Phase II was vegetative growth on top of the gravel media due to the addition of sediment. It is yet to

be tested if the vegetative growth is detrimental or not to the BMPs operation. This vegetative growth was experienced primarily on the filter trench and check dam filters with a minor area in the infiltration trench. In Phase II, the inlet pipes of the bioretention cells had to be cleaned due to grass clippings and other floatable debris clogging the inlet pipes at the four bioretention cells.

4.3 Link between Lab-scale and Field-scale Tests

Through this project, lab-scale tests were done on four rubber chip amended media, and field-scale tests were done on four literature reviewed media. Many aspects related to stormwater treatment through the use of roadside BMPs were tested on these 8 media types with a primary focus on the physical characteristics related to plant establishment and growth. In this section, we would try to evaluate the results obtained from both lab- and field-scale tests and link these results together in the context of the physical characteristics of the media used in this study. The purpose of relating lab- and field-scale testing is to see whether a BMP designer can obtain an idea of how a medium may perform in the field-scale BMPs based on its physical characteristics obtained from simple lab-scale testing.

The physical characteristics compared here include bulk density, field capacity, and wilting point, among others (Table 4.8). Other aspects were tested such as carbon-to-nitrogen ratio, phosphorus, cation ion exchange coefficients, etc., but are not discussed in this chapter because these characteristics were not tested on the lab BMP media tested.

Lab-scale testing showed that the best media for available moisture were in the silty loam/rubber reactor, which also had an acceptable saturated hydraulic conductivity value. Field-scale testing showed that all four media tested had similar available moisture values. However, the field-tested loam sand and wood mulch media showed a good percolation rate (116 in/h, the acceptable range is based on a 24 hour drawdown time which would be a rate greater than 0.375 in/h). Both media had site soil as a portion of the media. Table 4.8 also includes moisture testing results of the Lincoln and Omaha site soils. The site soils alone do not show values of available moisture as high as that of the engineered BMP soils. This shows how the addition of other media such as compost is beneficial. Although there are pros and cons (Table 4.9) for testing BMP media in the field and in the lab, the BMP designer can achieve a good initial understanding via the preliminary lab-scale tests of the media.

Table 4.8 Comparison of physical characteristics of lab and field-scale BMP media

Physical Property	Lab-scale BMP media				Field-scale BMP media				47-b and local soils		
	SLR ^a	SR	CR	R	50/50 C/S	40/60 C/47-b	30/50/20 L/S/WM	33/66 C/ES	I street 47-b	Lincoln Site Soil	Omaha Site Soil
Bulk Density (g/cm ³)	1.5	1.75	1.18	0.04	N/A	N/A	N/A	N/A	N/A	N/A	N/A
Field Capacity %	19.77	1.97	44.44	6.84	16.52	10.91	13.76	34.85	N/A	28.57	28.57
Wilting Point %	13.32	0.98	38.26	6.44	11.25	5.66	8.59	28.57	N/A	27.1	25.69
Available Moisture %	6.45	0.99	6.18	0.4	5.27	5.25	5.17	6.28	N/A	1.47	2.88
Percolation Rate (in/h)	N/A	N/A	N/A	N/A	40	1,252	116	1,047	683.1	N/A	N/A
Saturated Hydraulic Conductivity (in/h)	206.5	74	1283	3035.5	N/A	N/A	N/A	N/A	187.91	N/A	N/A

^aSLR = silty loam/rubber, SR = sand/rubber, CR = compost/rubber, R = rubber, C/S = compost sand, C/47-b = Compost 47-b, C/ES = compost expanded shale. Note: other characteristics tested in the field were: plant height, density, and image analysis, also chemical characteristics such as C:N ratio and C.E.C among others; other characteristics tested in the lab testing were: removal efficiency of various storm water constituents, i.e. copper, lead, zinc, TSS

Table 4.9 Pros and cons of field and lab scale media testing

Lab scale media testing		Field scale media testing	
Pros	Cons	Pros	Cons
Lower media cost because of smaller scale	Difficult to simulate weather conditions (e.g., rain, evaporation)	Actual weather conditions	Larger scale needs more materials
Controlled laboratory environment	Difficult to simulate plant growth	Actual plant growth environment	More variables and unknowns than laboratory conditions
Can be performed on an accelerated time line			Personnel must be present during storm events for sampling
			Limitations on testing possible because of minimal disturbance of media is required

Chapter 5 Conclusions and Recommendations

5.1 Deliverables and Summary

The major deliverables of the project (including both Phases I and II studies) are listed in Table 5.1. The major findings of Phase II studies can be summarized as follows:

Table 5.1 Information on deliverables and related methodologies used in the project

Deliverables from proposals	Activities and data collected	End results as deliverables (page # in report)
Collect information on weather conditions, storm events, maintenance issues	<ul style="list-style-type: none"> • Rain gauge data and flow sensor data • Logged maintenance issues • General pictures 	<ul style="list-style-type: none"> • Weather conditions and storm events were recorded by the deployed rain gauge and flow sensor (Ch. 2, Part II) • Maintenance issues were logged and photographed (Ch. 3, Part II)
Design of field BMPs and establishment of monitoring procedures	<ul style="list-style-type: none"> • Designed four different BMPs • Established monitoring procedures for the four BMPs and lab-scale BMPs 	<ul style="list-style-type: none"> • Details of design of the four BMPs (Ch. 2, Part I) • Established the HEC-HMS model for BMP studies (Chapter 2, Part II) • Different methods for monitoring of different BMPs (Chapter 3, Part II)
Plant establishment and sustainability with respect to: growth sustainability, height density, exposure conditions, and weed infestation	<ul style="list-style-type: none"> • Vegetative pictures/plant identification • Measure plant height • Soil samples 	<ul style="list-style-type: none"> • Good bio-cell plant growth based on image J analysis (Ch. 3, Part II) • Good media based on physical plant growth characteristics tested in the lab-scale BMPs (Ch. 3, Part I) and in the field-scale BMPs (Ch. 3, Part II)
Evaluation of the performance of BMPs with respect to: erosion/rill development, sedimentation interception, clogging of medium, soil core samples, and infiltration rates	<ul style="list-style-type: none"> • Grab sample TSS • Side slope TSS • Basket rocks/total solids from medium • Percolation tests/drawdown rate • Soil samples 	<ul style="list-style-type: none"> • Erosion/rill development results based on side slope TSS (Ch. 3, Part II) • Sediment interception and clogging of different BMPs (Ch. 3, Part II) • Core samples taken from bio-cells and check dam filters (Ch. 3, Part II) • Infiltration rates from infiltration trench observation wells and percolation tests on check dam filters (Ch. 3, Part II)
Feasibility of field BMPs for highway runoff treatment	<ul style="list-style-type: none"> • Cost analysis of BMP construction, operation, and maintenance • BMPs lifespan/maintenance issues 	<ul style="list-style-type: none"> • Material estimates and actual construction costs (Ch. 4, Part II) • Mass balance of sediment and clogging in BMPs (Ch. 4, Part II) • Evaluation of major maintenance issues (Ch. 3 and Ch. 4, Part II)
Linking the results of lab- and field-scale BMPs together	<ul style="list-style-type: none"> • Compared physical characteristics of the media used in different BMPs • Analyzed pros and cons of testing media with field- or lab-scale BMPs 	<ul style="list-style-type: none"> • A BMP designer can achieve a good initial understanding (e.g., leaching heavy metals, or improving growth limiting bulk density, moisture holding capacity, or available moisture) via the preliminary lab-scale tests of the media (Ch. 4, Part II).

- From the bioretention test cell vegetative monitoring, it was found that the cells with the 30% loam 50% sand 20% mulch mix and with the 50% compost 50% sand mix had the best vegetative growth and the best physical characteristics to support vegetative growth and establishment.
- The infiltration trench had minimal sediment interception and clogging but showed

slow drawdown times in the spring months.

- The filter trench monitoring showed a TSS percent removal ranging from -275% to about 75%, with negative representing leaching or a net increase in TSS. It was found that most of the problems associated with sedimentation in the filter trench were apparently due to poor soil stabilization on the side-slopes of the trench.
- The check dam filters had a large amount of initial clogging during the Phase I time frame but were reassessed during Phase II, and it was found that drawdown times were still within range for operation.

5.2 Recommendations

Results obtained from this two-phase project can be used to design and build field-scale BMPs in eastern Nebraska (e.g., areas near Omaha and Lincoln). However, it is recommended to build and test several field-scale BMPs in ultra-urban settings as well as central and western Nebraska so that the climate and geographic conditions could be thoroughly evaluated. In addition, it is recommended that the existing BMPs at Salt-Valley and I-street be monitored continuously (or at least after 5 years be monitored once) for the BMPs' performance (e.g., plant development, efficiency for both water quantity and quality control). These future studies will provide critical information on the media and plant species that will be the most successful in municipal highway locations in Nebraska. Results can be used to modify the design and management of BMPs for long-term and field-scale application under different conditions (e.g., locations and geographic conditions).

References

- ASA. (1982). *Methods of Soil Analysis - Part 2: Chemical and Microbiological Properties, Second Edition*. American Society of Agronomy.
- Crites, R., and Tchobanoglous, G. (1998). *Small and Decentralized Wastewater Management Systems*. Tom Casson, McGraw-Hill Companies.
- Gassman, P. W., Reyes, M. R., Green, C. H., and Arnold, J. G. (2007). "The soil and water assessment tool: Historical development, applications, and future research directions." *Transactions of the ASABE*, 50(4), 1211-1250.
- Girma, K., Zhang, H., and Roberts, W. *Building Soil Organic Matter for a Sustainable Organic Crop Production*. Rep. No. PSS-2257, Oklahoma Cooperative Extension Service, . <http://pods.dasnr.okstate.edu/docushare/dsweb/Get/Document-6125/PSS-2257web.pdf>
- Gupta, H. V., Sorooshian, S., and Yapo, P. O. (1999). "Status of automatic calibration for hydrologic models: Comparison with multilevel expert calibration." *J. Hydrol. Eng.*, 4(2), 135-143.
- Gupta, R. S. (2008). *Hydrology and Hydraulic Systems* (3rd ed.). Long Grove: Waveland Press, Inc., Long Grove, Illinois.
- Hatt, B. E., Fletcher, T. D., and Deletic, A. (2008). "Hydraulic and pollutant removal performance of fine media stormwater filtration systems." *Environ. Sci. Technol.*, 42(7), 2535–2541.
- Heckman, J. R. (2003). *Soil Nitrate Testing as a Guide to Nitrogen Management for Vegetable Crops*. Rep. No. E285, Rutgers Cooperative Extension, New Jersey Agricultural Experiment Station, Rutgers. http://njveg.rutgers.edu/assets/pdfs/soil/e285-jhSoil%20Nitrate_Testing_as_Guide_to_Nitrogen_Management_for_Vegetable.pdf
- Hutchinson, K. J., and Christiansen, D. E. (2013). *Use of the Soil and Water Assessment Tool (SWAT) for simulating hydrology and water quality in the Cedar River Basin, Iowa, 2000–10*. U.S. Geological Survey Scientific Investigations Report 2013–5002, 36 p.. http://pubs.usgs.gov/sir/2013/5002/sir13_5002.pdf
- ISMM. (2009). "Iowa stormwater management manual." http://www.intrans.iastate.edu/publications/_documents/handbooks-manuals/storm-water/Design/2E/2E-4%20Bioretention%20Systems.pdf (accessed Oct. 2013).

- Jones, J., and Benton, J. (2001). *Laboratory Guide for Conducting Soil Tests and Plant Analysis*. Taylor and Francis, Hoboken.
- Manjula, N. V. (2010). "Improving lawn and landscape soils." <http://extension.missouri.edu/p/g6955> (accessed on September, 26, 2013).
- Ming-Han, L., Chan, Y., Sung, Myung, H., Kim, and Kung-Hui, C. (2010). *Bioretention for stormwater quality improvement in Texas: pilot experiments*. Texas Department of Transportation, Austin, Texas.
- Moriassi, D. N., Arnold, J. G., Van Liew, M. W., Bingner, R. L., Harmel, R. D., and Veith, T. L. (2007). "Model evaluation guidelines for systematic quantification of accuracy in watershed simulations." *Transactions of the ASABE*, 50(3), 885-900.
- National Climatic Data Center (NCDC). (2012). "Monthly climatological summary." <http://www1.ncdc.noaa.gov/pub/orders/96364.pdf>, <http://www1.ncdc.noaa.gov/pub/orders/96368.pdf> (accessed on Oct. 2013).
- National Resource Conservation Service (NRCS). (1986). "Urban hydrology for small watersheds TR - 55." <http://www.cpsc.org/reference/tr55.pdf> (accessed on Oct. 2013).
- NCR. (1998). *Recommended Chemical Soil Test Procedures for the North Central Region. No. 499 (revised)*. North Dakota State University, .
- NDOR. (2010). "Seeding Handbook for Highway Maintenance." Nebraska Department of Roads.
- Patton, A., Walker, K., McDuffee, D., Bigelow, C., Latin, R., and Reicher, Z. (2005). "Using digital image analysis to quantify turfgrass cover and disease." <http://www.agry.purdue.edu/turf/report/2005/11.pdf> (accessed on Oct. 2013).
- PGCM. (2007). *Bioretention Manual: Environmental Services Division Department of Environmental Resources the Prince George's County, Maryland*. Prince George county department of environmental resources. http://www.aacounty.org/DPW/Highways/Resources/Raingarden/RG_Bioretention_PG%20CO.pdf
- RMST. (1974). "Handbook on Reference Methods for Soil Testing." Council on Soil Testing and Plant Analysis, .
- Singh, J., Knapp, H. V., and Demissie, M. (2004). *Hydrologic modeling of the Iroquois River watershed using HSPF and SWAT*. ISWS CR 2004-08. Champaign, Ill.: Illinois

State Water Survey." <http://www.isws.illinois.edu/pubdoc/CR/ISWSCR2004-08.pdf> (accessed Oct. 2013).

Teledyne ISCO. (1999). *2150 Area Velocity Flow Module and Sensor Installation and Operation Guide*. Teledyne ISCO, Inc..
<http://isco.com/pcfiles/PartPDF/SL000004/UP00163Z.pdf>

Thompson, A. M., Paul, A. C., and Balster, N. J. (2008). "Physical and hydraulic properties of engineered soil media for bioretention basins." *Transactions of the ASABE*, 51(2), 499-514.

USACE-HEC. (2000). *Hydrologic Modeling System HEC-HMS, Technical Reference Manual*. US Army Corps of Engineers, Hydrologic Engineering Center.

USDA. *USDA Agriculture Handbook 60*.
<http://www.ars.usda.gov/Services/docs.htm?docid=10158>

USEPA. (1999). *Storm Water Technology Fact Sheet Bioretention*. Rep. No. EPA 832-F-99-012, United States Environmental Protection Agency, Office of Water Washington, D.C.

Virginia DCR. (2011). *Virginia DCR Stormwater Design Specification No. 9 Bioretention Version 1.9*. <http://vwrrc.vt.edu/swc/NonPBMPSpecsMarch11/VASWMBMPSpec9BIORETENTION.html> (accessed September 26, 2013).

Hunt, W. F. (2004). "Urban Waterways: Bioretention Performance, Design, Construction, and Maintenance."
<http://www.bae.ncsu.edu/stormwater/PublicationFiles/Bioretention2006.pdf>

WRA Environmental Consultants (2009). *Appendix B Soils, plantings, and irrigation for bioretention facilities In stormwater C.3 Guidebook, 5th ed.* Contra Costa Clean Water Program.

Appendix A Individual HEC-HMS flowrates and grab sample times

Storm 2, 4/17/13

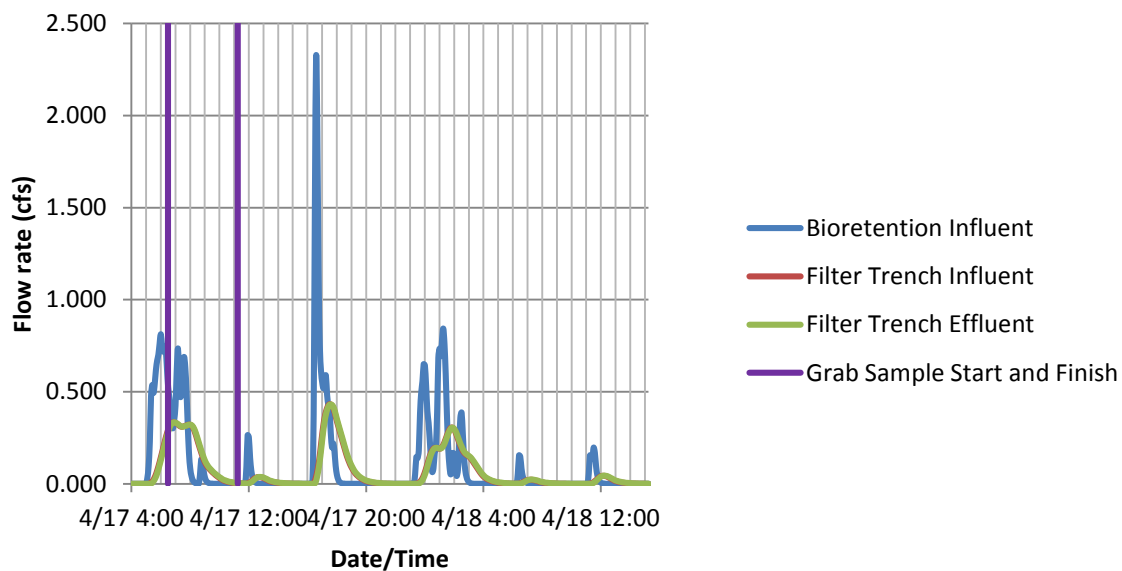

Storm 4, 5/1/13

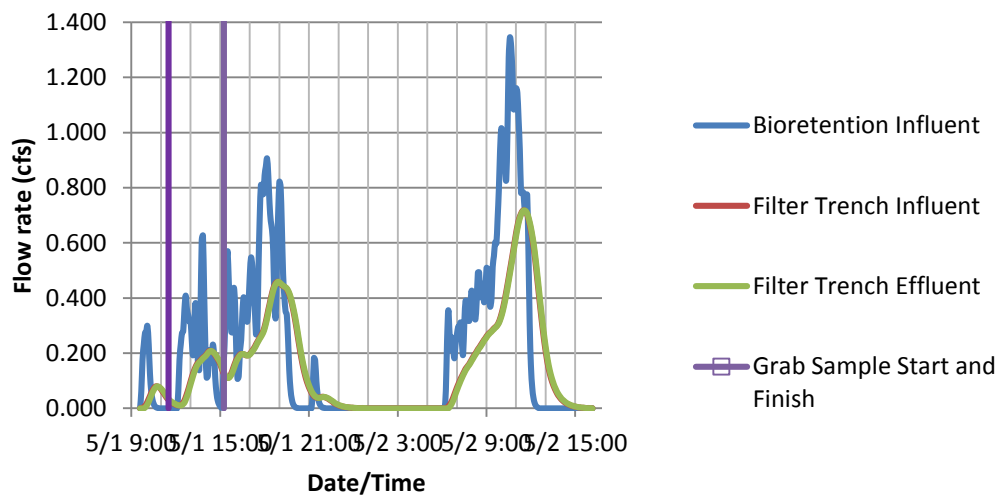

Storm 5, 5/18/13

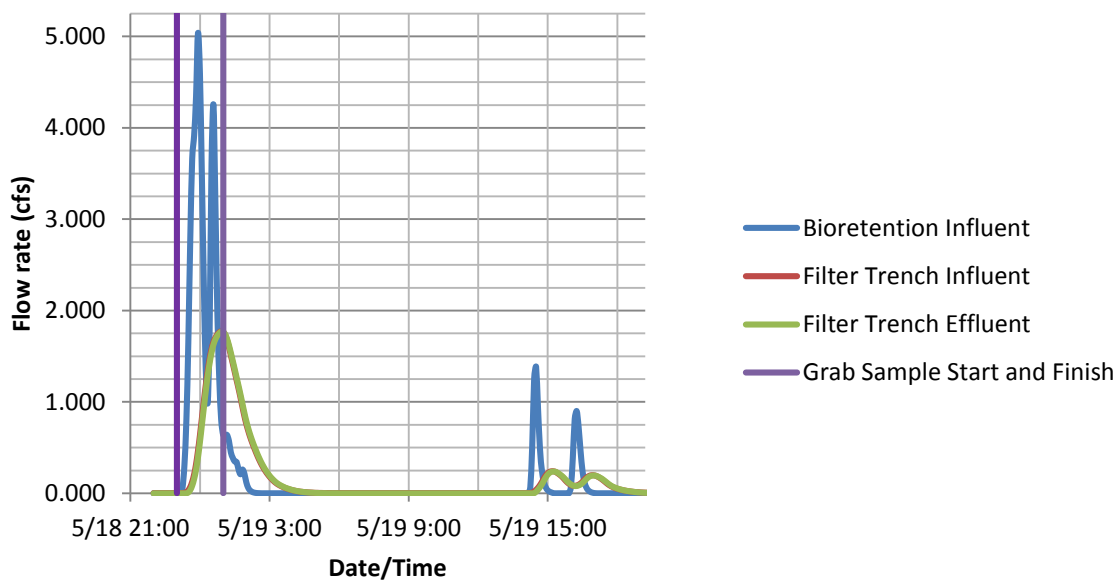

Storm 12, 6/27/13

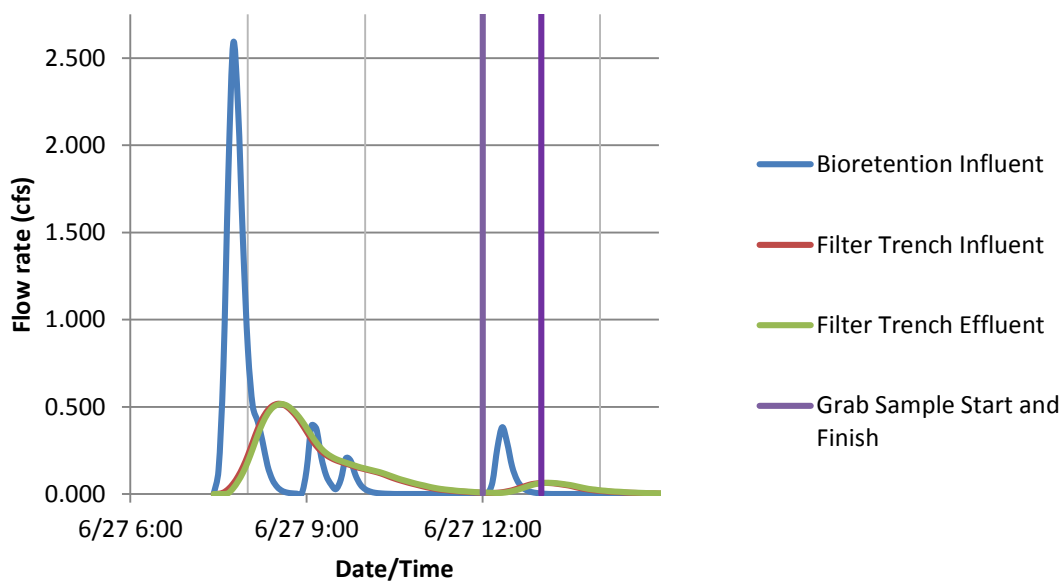

Storm 14, 7/29/13

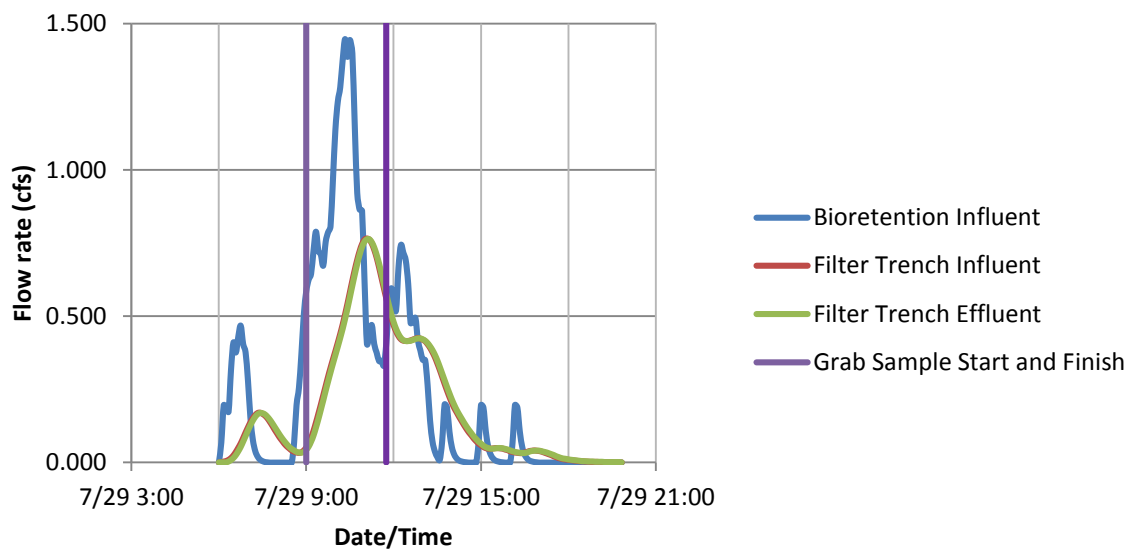

Storm 15, 8/1/13

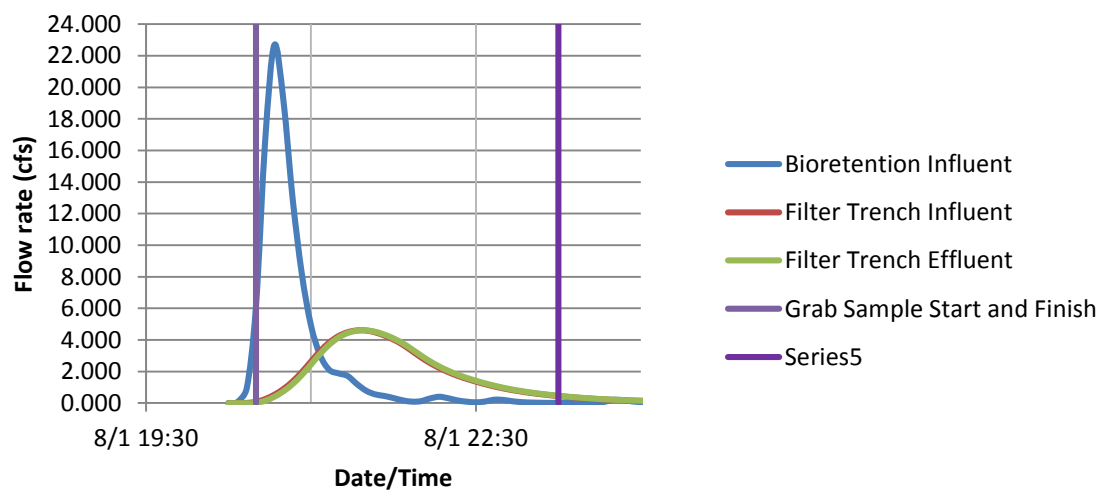

Storm 6, 5/25/13

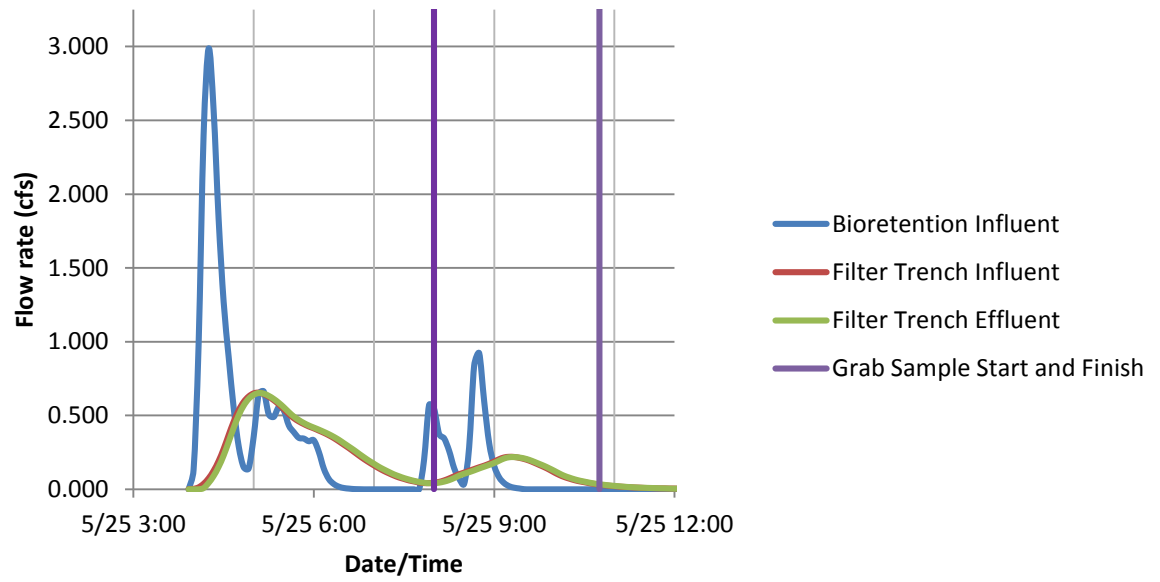

Appendix B Vegetative Analysis Results

Image J results looking North

test plot	50/50 compost/sand	40/60 compost/47 -b	30/50/20 loam/sand/wood mulch	33/66 compost/expanded shale
4/29	46.99	57.56	46.83	28.06
5/24	92.38	89.21	64.26	76.84
6/4	85.70	75.37	57.73	49.26
6/17	98.36	88.80	89.10	31.70
6/21	98.79	84.92	91.04	30.81
6/23	98.59	88.10	93.91	29.50
6/27	98.38	90.42	95.95	38.02
7/11	65.67	45.81	88.45	48.89
7/18	46.57	30.32	66.94	54.06
8/5	66.65	33.77	39.98	87.60
8/13	63.43	27.34	60.82	84.95
8/19	72.25	50.75	81.62	88.86
9/1	50.25	22.72	54.54	83.94
Average	75.69	60.39	71.63	56.35
Standard of Deviation	19.86	25.68	18.50	23.63
rank	1	3	2	4

Vegetation image looking north

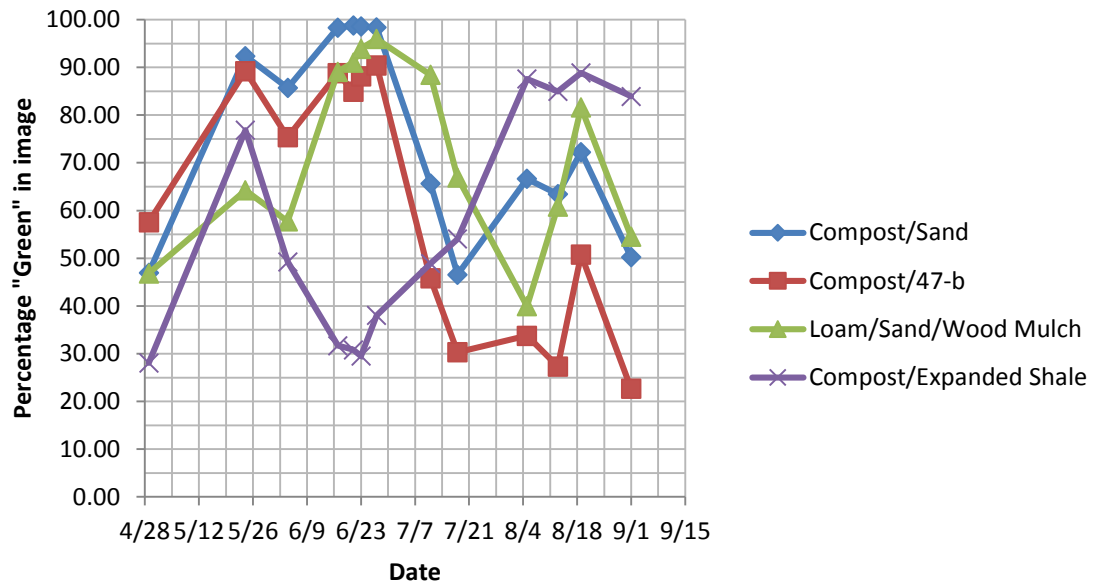
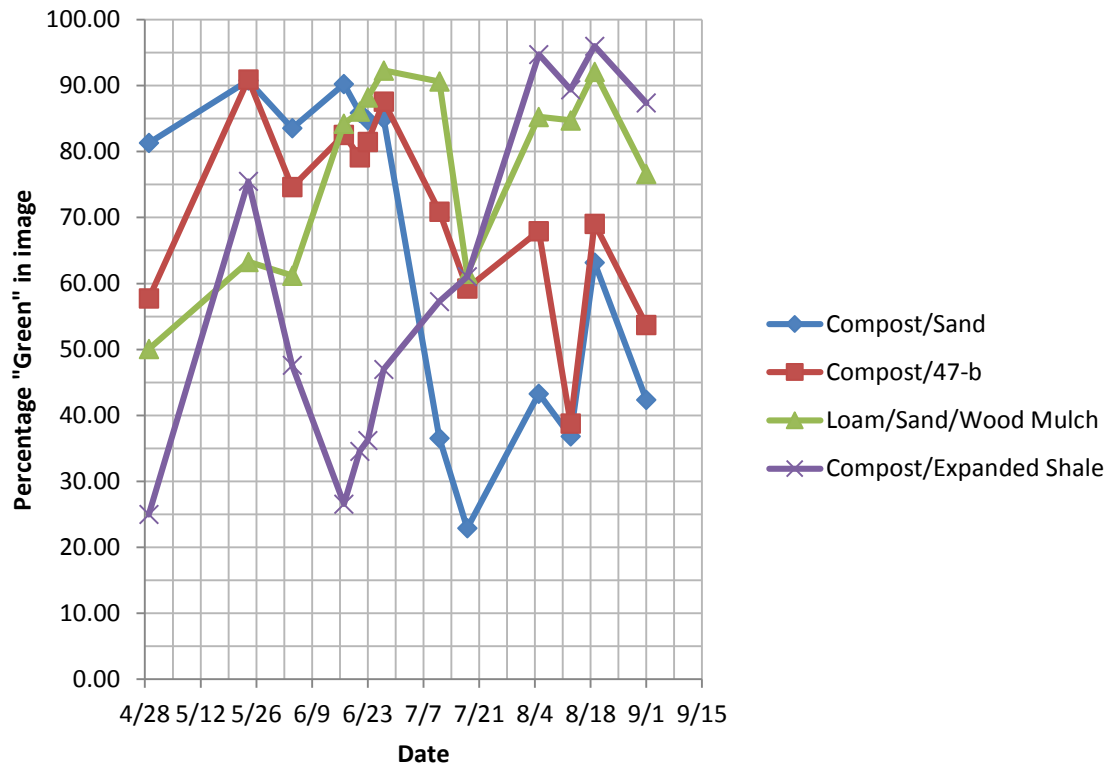

Image J results looking South

est plot	50/50 compost/san d	40/60 compost/47 -b	30/50/20 loam/sand/woo d mulch	33/66 compost/expande d shale
4/29	81.31	57.73	50.07	24.99
5/24	90.77	90.95	63.29	75.49
6/4	83.54	74.62	61.21	47.60
6/17	90.25	82.55	84.23	26.56
6/21	85.91	79.14	86.07	34.58
6/23	84.76	81.48	88.20	36.22
6/27	85.00	87.60	92.29	46.98
7/11	36.56	70.91	90.63	57.26
7/18	22.92	59.27	61.50	61.04
8/5	43.31	67.95	85.26	94.73
8/13	36.83	38.79	84.74	89.38
8/19	63.18	69.06	92.10	95.98
9/1	42.35	53.72	76.62	87.37
Average	65.13	70.29	78.17	59.86
Standard of Deviation	24.02	14.28	13.65	25.18
rank	3	2	1	4

Vegetation image looking south



Appendix C Individual Grab Sample Results

TSS Samples Storm 2 4/17

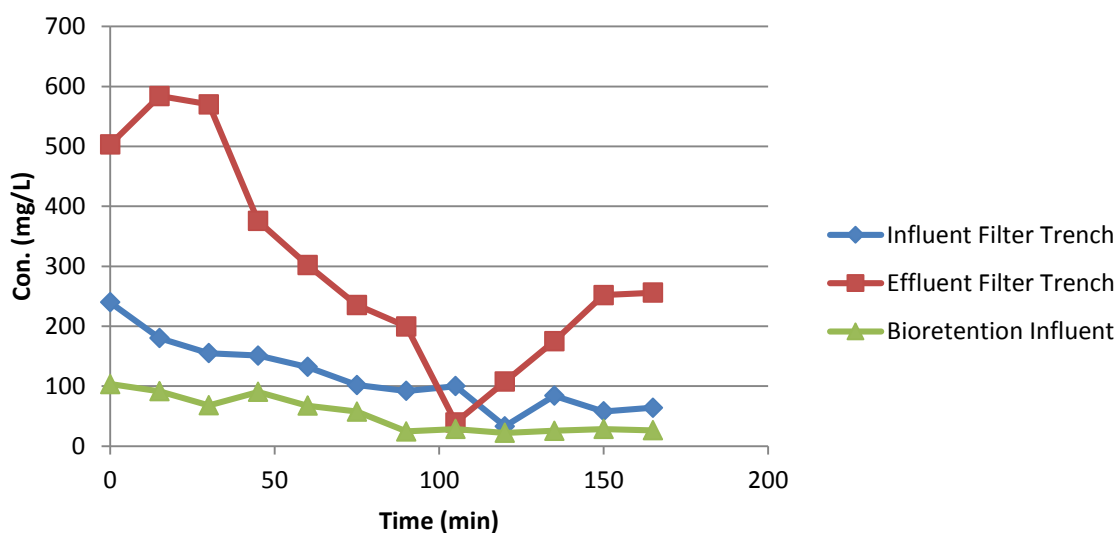

TSS Samples Storm 4 5/1

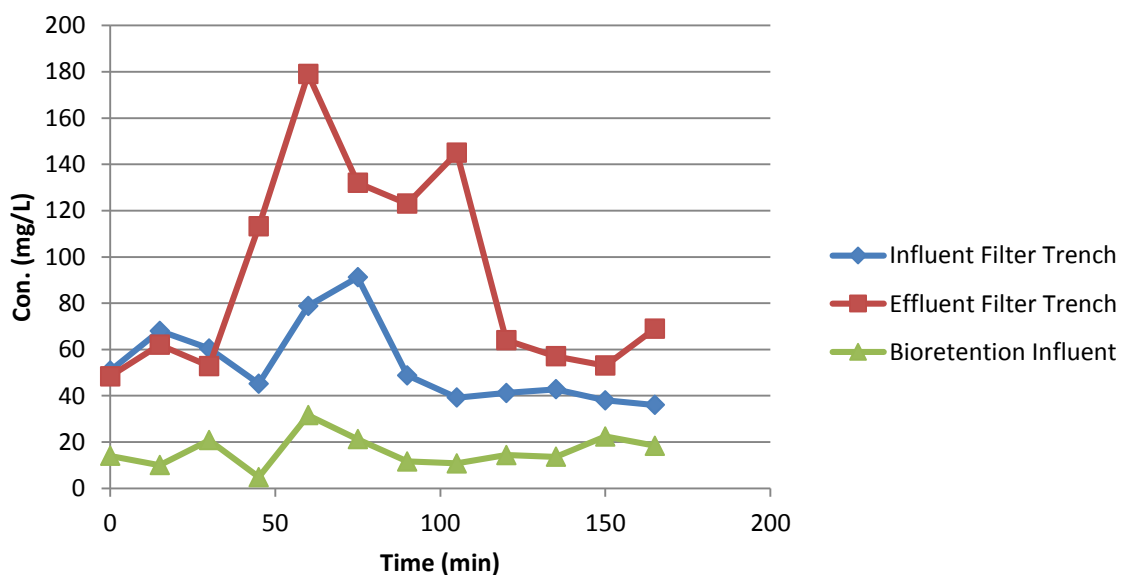

TSS Samples Storm 5 5/18

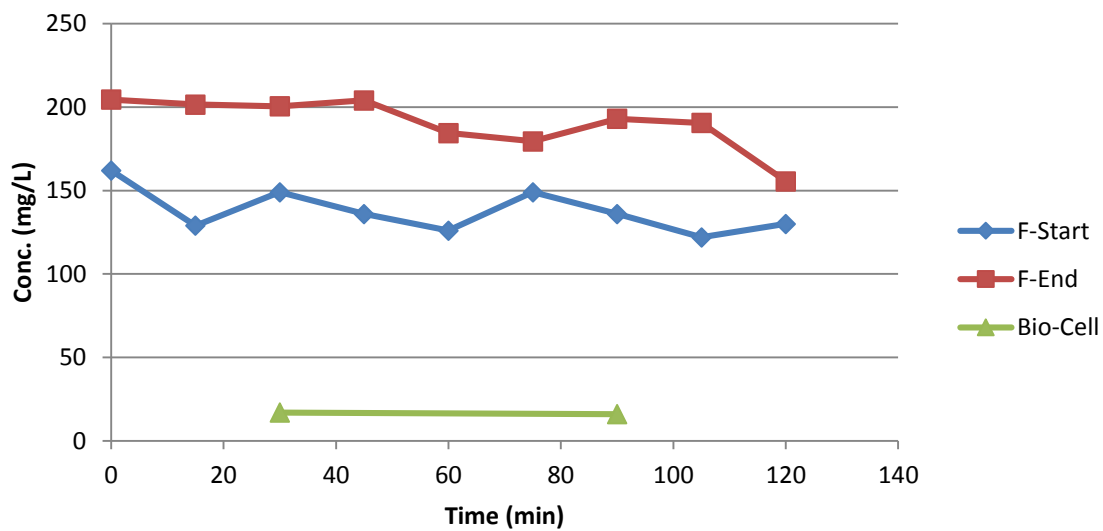

TSS Samples Storm 6 5/25

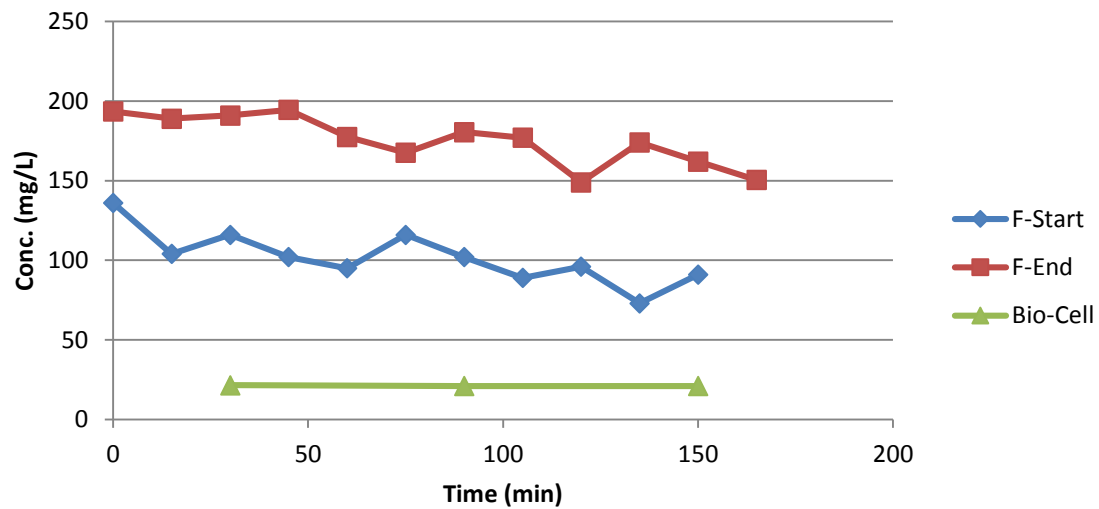

TSS Samples Storm 12 6/27

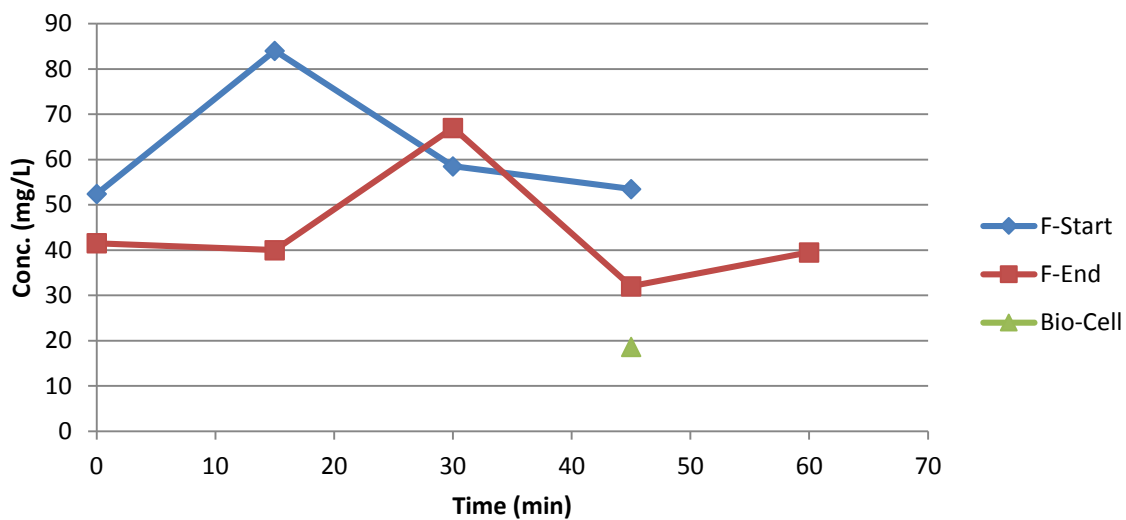

TSS Samples Storm 14 7/29

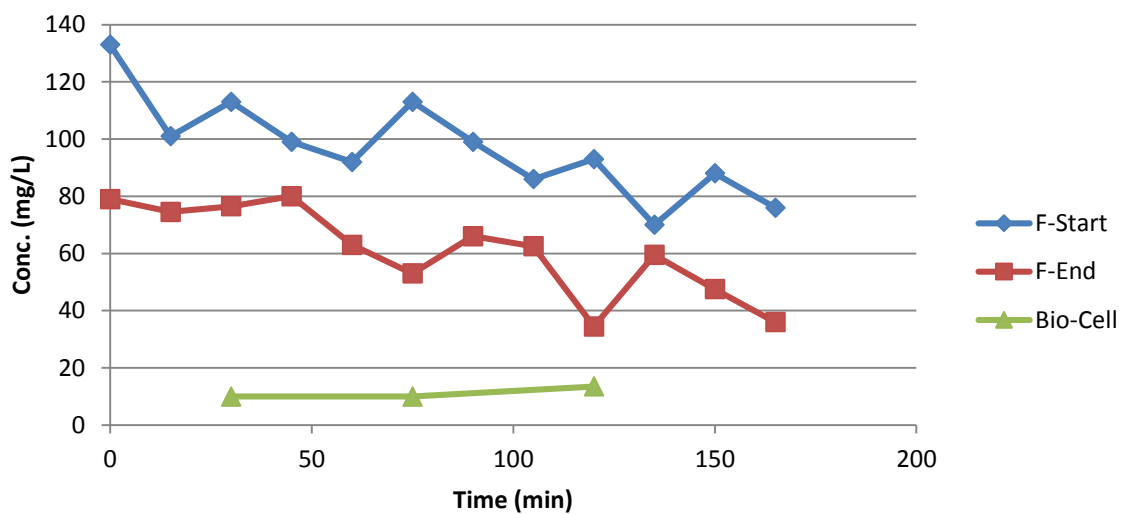

TSS Samples Storm 15 8/1

