



MID-AMERICA
TRANSPORTATION CENTER



Report SPR-P1(16) M034

Final Report
26-1121-4026-001

Design and Evaluation of Modified Centerline Rumble Strips

Yong-Rak Kim, Ph.D.

Professor
Department of Civil Engineering
University of Nebraska-Lincoln

Taesun You, Ph.D.

Postdoctoral Research Associate

Laurence R. Rilett, Ph.D., P.E.

Keith W. Klaasmeyer Chair in Engineering and Technology

2017

Nebraska Transportation Center
262 Prem S. Paul Research Center at Whittier School
2200 Vine Street
Lincoln, NE 68583-0851
(402) 472-0141

"This report was funded in part through grant[s] from the Federal Highway Administration [and Federal Transit Administration], U.S. Department of Transportation. The views and opinions of the authors [or agency] expressed herein do not necessarily state or reflect those of the U.S. Department of Transportation."

Design and Evaluation of Modified Centerline Rumble Strips

Yong-Rak Kim, Ph.D.

Professor

Department of Civil Engineering

University of Nebraska-Lincoln

Taesun You, Ph.D.

Postdoctoral Research Associate

Department of Civil Engineering

University of Nebraska-Lincoln

and

Laurence R. Rilett, Ph.D., P.E.

Keith W. Klaasmeyer Chair in Engineering and Technology

Director, Nebraska Transportation Center

University of Nebraska-Lincoln

A Report on Research Sponsored by

Nebraska Department of Roads

March 2017

Technical Report Documentation Page

1. Report No SPR-P1(16) M034	2. Government Accession No.	3. Recipient's Catalog No.	
4. Title and Subtitle Design and Evaluation of Modified Centerline Rumble Strips		5. Report Date March 8, 2017	
		6. Performing Organization Code	
7. Author/s Y-R. Kim, T. You, and L. R. Rilett		8. Performing Organization Report No. 26-1121-4026-001	
9. Performing Organization Name and Address University of Nebraska-Lincoln, Department of Civil Engineering 362 Whittier Research Center, Lincoln, NE 68583-0856		10. Work Unit No. (TRAIS)	
		11. Contract or Grant No.	
12. Sponsoring Organization Name and Address Nebraska Department of Roads 1400 Highway 2, PO Box 94759, Lincoln, NE 68509		13. Type of Report and Period Covered	
		14. Sponsoring Agency Code	
15. Supplementary Notes			
16. Abstract A centerline rumble strip (CLRS) is primarily installed on the centerline of undivided two-lane and two-way roadways to alert drivers that they are moving out of their intended travel lane. The main purpose of CLRSs is to reduce cross-over collisions typically caused by inattentive, distracted, drowsy, or fatigued drivers. Despite the safety benefits, CLRSs that were milled over or adjacent to the centerline joint may increase or accelerate the deterioration and degradation of the pavement structure, which has been observed in Nebraska pavements. In this research project, new (or modified) CLRS designs were sought to reduce pavement damage, while satisfying the safety purpose of CLRSs. A literature review including a survey of the CLRS design practices in different states and discussions with the project technical advisory committee (TAC) members resulted in three proposed modified CLRS designs. Then, the current (8"-4"-8" with 0.5" depth) and modified designs (6"-6"-6" with 0.5" depth, 5"-7"-5" with 0.375" depth, and 6"-8"-6" with 0.5" depth) were evaluated using finite element pavement modeling and simulations to assess the stress and damage potential of pavements associated with the different CLRS designs. Two primary types of pavements in Nebraska (i.e., composite pavements and concrete pavements) were considered. Model simulation results demonstrated that pavements with CLRSs showed higher stress than pavements without CLRSs. In addition, each CLRS design induced different stress distributions (and damage potential) due to different tire-pavement contact. The highest stress typically occurred at the corner/edge of the CLRS, and the current CLRS design (i.e., 8"-4"-8" with 0.5" depth) produced higher stress (or damage potential) than the modified designs in both types of pavements. A comparison of the three modified CLRS designs in this study showed that one modified design (6"-6"-6" with 0.5" depth) generally yielded the lowest stress. This research provides preliminary insights into how a modified CLRS design can reduce the pavement damage, while the findings should be validated through field testing in a follow-up effort.			
17. Key Words: centerline rumble strip design, pavement, finite element simulation, damage prediction		18. Distribution Statement	
19. Security Classification (of this report) Unclassified	20. Security Classification (of this page) Unclassified	21. No. of Pages 31	22. Price

Form DOT F 1700.7 (8-72) Reproduction of form and completed page is authorized

Table of Contents

Chapter 1	Introduction.....	1
1.1	Research Objectives and Scope	4
Chapter 2	Literature Review.....	5
2.1	Benefits of CLRSs	5
2.2	Existing CLRS Designs	6
2.3	Stimuli Levels for Effective CLRSs	9
2.4	CLRS Concerns	10
2.5	Studies on CLRSs by State DOTs	10
Chapter 3	Design of Modified CLRS	12
Chapter 4	Pavement Modeling and Simulations	14
4.1	Composite Pavement Modeling and Simulations	14
4.2	Concrete Pavement Modeling and Simulations	21
Chapter 5	Summary and Conclusions	29
References	30

List of Figures

Figure 1-1. Placement types of milled CLRSs: (a) CLRSs within pavement marking; (b) CLRSs that extend into the travel lane; (c) CLRSs on either side of pavement marking (Torbic 2009)....	2
Figure 1-2. Milled CLRSs design used in Nebraska: (a) plan view; (b) profile.	2
Figure 1-3. Pavement damage associated with CLRSs.	3
Figure 1-4. CLRSs in Nebraska: (a) old design; (b) current design.	3
Figure 2-1. Accumulated miles CLRS installed per year with crossover crash rate (Manchas et al. 2011).	5
Figure 2-2. Dimensions of CLRSs.....	7
Figure 3-1. Three modified CLRS designs considered.....	13
Figure 4-1. A schematic cross-sectional profile of a composite pavement structure and its mesh.	15
Figure 4-2. Four finite element meshes of a composite pavement with different CLRS designs.	16
Figure 4-3. Zoomed-in finite element meshes of a composite pavement with different CLRSs..	17
Figure 4-4. Two different tire loading scenarios considered for composite pavement modeling.	18
Figure 4-5. Stress contour plots of composite pavement without and with CLRSs: 1 st loading. .	18
Figure 4-6. Zoomed-in views of CLRS edges-corners of composite pavement: 1 st loading.....	19
Figure 4-7. Stress contour plots of composite pavement without and with CLRSs: 2 nd loading.	20
Figure 4-8. Zoomed-in views of CLRS edges-corners of composite pavement: 2 nd loading.	21
Figure 4-9. Finite element model of a concrete pavement in this study.	22
Figure 4-10. Zoomed-in finite element meshes of a concrete pavement with different CLRSs. .	23
Figure 4-11. Two different tire loading scenarios considered for concrete pavement modeling.	24
Figure 4-12. Stress contour plots of concrete pavement without and with CLRSs: 1 st loading. ..	25
Figure 4-13. Zoomed-in views of CLRS edges-corners of concrete pavement: 1 st loading.	26
Figure 4-14. Stress contour plots of concrete pavement without and with CLRSs: 2 nd loading. .	27
Figure 4-15. Zoomed-in views of CLRS edges-corners of concrete pavement: 2 nd loading.	28

List of Tables

Table 2-1. Summary of Safety Benefits Attributed to Installation of CLRS.....	6
Table 2-2. Summary of CLRS Practices in the United States (Torbic et al. 2009)	8
Table 3-1. <i>SLDiff</i> Values of CLRS Designs (Three Modified and One Current).....	13
Table 4-1. Material Properties of Each Layer.....	15
Table 4-2. Material Properties of Concrete Pavement.....	22

Disclaimer

This report was funded in part through grant[s] from the Federal Highway Administration [and Federal Transit Administration], U.S. Department of Transportation. The views and opinions of the authors [or agency] expressed herein do not necessarily state or reflect those of the U. S. Department of Transportation.

Acknowledgements

The authors thank the Nebraska Department of Roads (NDOR) for the financial support needed to complete this study. In particular, the authors thank NDOR Technical Advisory Committee (TAC) for their technical support and invaluable discussions/comments.

Chapter 1 Introduction

A centerline rumble strip (CLRS) is primarily installed on the centerline of undivided two-lane and two-way roadways to alert drivers that they are moving out of their intended travel lane. The main purpose of CLRSs is to reduce cross-over collisions, such as head-on, opposite-direction sideswipe, and front-to-side crashes, typically caused by inattentive, distracted, drowsy, or fatigued drivers. Several studies (Karkle 2011; Karkle et al. 2011; Karkle et al. 2013; Russell and Rys 2005; Torbic 2009) reported the effectiveness of CLRSs. For example, installing CLRSs reduced head-on crashes by 34% to 95% (Torbic 2009), and crossover crashes and run-off-the-road crashes were reduced by 67% and 19%, respectively (Karkle 2011). Karkle et al. (2011) suggests the following additional benefits of CLRSs:

- Low interference in passing maneuvers;
- Versatile installation conditions;
- Low cost installation and maintenance;
- High benefit-cost ratios.

Therefore, 36 states in the United States have installed CLRSs (Karkle et al. 2013). Most states have used milled CLRSs, which includes: (a) CLRSs within the pavement markings, (b) CLRSs that extend into the travel lane, and (c) CLRSs on either side of the pavement markings (see Figure 1-1). About 80% of states installed CLRSs either within pavement marking (Figure 1-1(a)) or extending into travel lanes (Figure 1-1(b)). National Cooperative Highway Research Program (NCHRP) Report 641, Guidance for the Design and Application of Shoulder and Centerline Rumble Strips (Torbic 2009), reports that the predominant pattern dimensions of CLRSs are: 16 inches in length, 7 inches in width, and 0.5 inches in depth with 12-inch spacing.

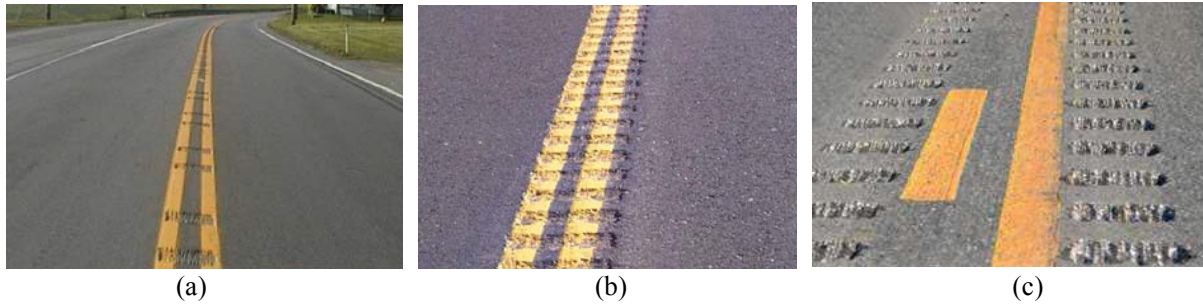

Figure 1-1. Placement types of milled CLRSS: (a) CLRSS within pavement marking; (b) CLRSS that extend into the travel lane; (c) CLRSS on either side of pavement marking (Torbic 2009).

The milled CLRSS in Nebraska are installed on rural two-lane and two-way undivided roadways where the posted speed limit is 50 mph or greater. The lane width for CLRSS should not be less than 11 feet, and edge line rumble strips require a lane width of 12 feet. CLRSS dimensions in Nebraska are: 8 inches in length, 7 inches in width, and 0.5~0.625 inches in depth with 5-inch spacing, as shown in Figure 1-2. Karkle (2011) reports a 64% decrease in cross-over crashes over a three-year period when CLRSS were installed in two locations in Nebraska (U.S. Highway 34 from Lincoln to Seward and U.S. Highway 77/Nebraska Highway 92 from Wahoo to Yutan).

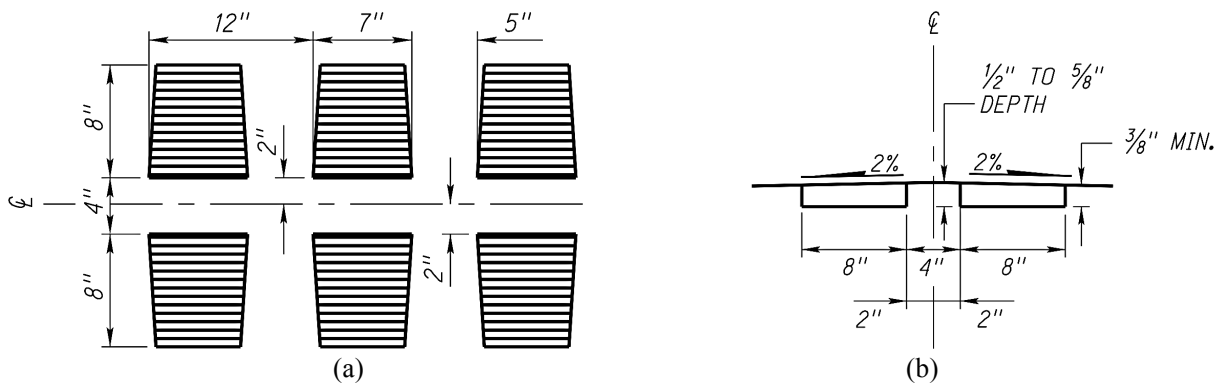

Figure 1-2. Milled CLRSS design used in Nebraska: (a) plan view; (b) profile.

Despite the safety benefits, several pavement performance concerns associated with CLRSS have been reported (Torbic 2009). In particular, CLRSS that were milled over or adjacent to the centerline joint (even if it is hardly distinguishable), which is a damage-sensitive region of pavement, may increase or accelerate the deterioration and degradation of the pavement structure (Figure 1-3). It also requires more maintenance and attention due to potential safety concerns. To reduce pavement damage, the CLRSS design has been modified from a single strip over the

centerline joint (Figure 1-4(a)) to dual strips straddling the joint (Figure 1-4(b)) in Nebraska. The modified design may decrease pavement damage; however, improving the CLRS design is imperative.

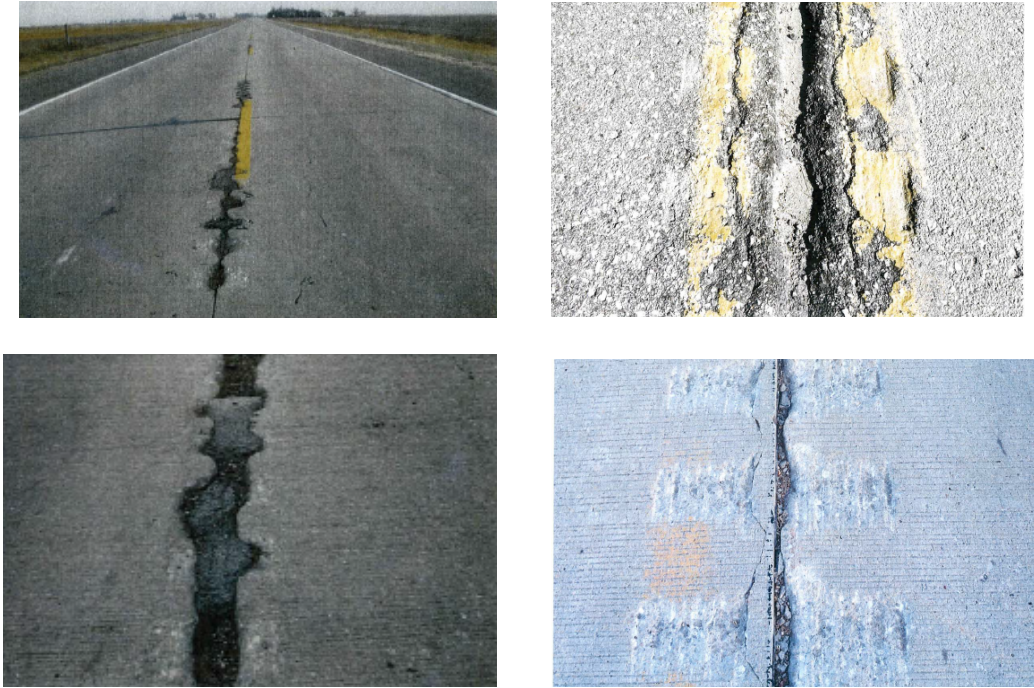

Figure 1-3. Pavement damage associated with CLRSs.



Figure 1-4. CLRSs in Nebraska: (a) old design; (b) current design.

To maximize the safety benefits of CLRSs and minimize pavement damage, a series of research activities must be performed. In this particular research project, the configurations and dimensions of the CLRSs built or tested by other states were collected. Surveys of the corresponding lane

widths required or suggested by other Departments of Transportation (DOTs) were also necessary. These findings were then used to improve current dual CLRSs so that they satisfy the expected structural performance and roadway safety requirements. Then, the proposed CLRS designs were evaluated and compared with the current design using structural model simulations. Due to the limited time and scope of this project, this study sought to collect data and practices from other states to recommend modifications to the current CLRS design and evaluate the recommended design through model simulations that compare the newly proposed design with the current CLRS design practice. Field test evaluations of the modified design can then be conducted in a follow-up research effort.

1.1 Research Objectives and Scope

This research designs and evaluates modified CLRSs in Nebraska. Therefore, a literature review on the CLRSs built and tested by other states was conducted. The corresponding guidance and requirements were also surveyed. Based on this literature review, modified CLRSs were proposed. Then, the current and modified CLRS designs were evaluated using finite element pavement modeling and simulations so one or two of the best designs could be suggested for further evaluation in a follow-up research project in the field. This research sought to provide insight into how the modified CLRS designs can reduce the pavement damage caused by the current design.

Chapter 2 Literature Review

2.1 Benefits of CLRSs

The primary purpose of CLRSs is to prevent potential crashes with opposing traffic by warning drivers that their vehicles are crossing the centerlines of two-lane and two-way roadways. Some benefits of CLRSs include (Datta et al. 2015; Harkey et al. 2008; Karkle 2011; Manchas et al. 2011):

- Prevention of head-on, sideswipe, and opposite direction run-off-the road collisions;
- Cost-effectiveness;
- Relatively fast installation;
- Improved visibility of the pavement markings, particularly in wet or night conditions.

CLRSs reduce all crashes by 14% and head-on and opposite-direction sideswipe crashes by 21% on rural two-lane roads (Harkey et al. 2008). CLRSs also reduce all injury crashes by 15% and all injury head-on and opposite-direction sideswipe crashes by 25% on rural two-lane roads. Moreover, as the amount of installed CLRS increases, the crossover crash rate is significantly reduced, as shown in Figure 2-1. Table 2-1 summarizes the results of safety benefits attributed to installation of CLRS.

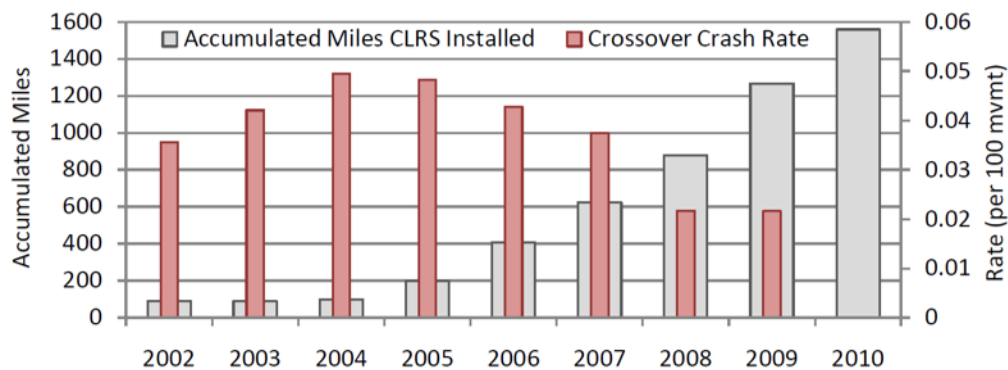

Figure 2-1. Accumulated miles CLRS installed per year with crossover crash rate (Manchas et al. 2011).

Table 2-1. Summary of Safety Benefits Attributed to Installation of CLRS

State	Type of facility	Type of collisions targeted	Crash reduction (%)
Arizona (AECOM 2008)	Rural two-lane road	Crossover	61
California (Fitzpatrick 2000)	Rural two-lane road	Head-on	42
Colorado (Outcalt 2001)	Rural two-lane road	Head-on	34
		Sideswipe	37
Delaware (Delaware DOT 2005; Persaud et al. 2004)	Rural two-lane road	Head-on	95
		Drove left of center	60
		Crossover	81
Kansas (Karkle et al. 2009)	Rural two-lane road	Head-on	81
		Sideswipe	78
		Crossover	80
Minnesota (Briese 2006; Knapp and Schmit 2009)	Rural two-lane road	Head-on/ opposite- direction sideswipe	43
		Crossover	47
Missouri (Missouri DOT)	Rural two-lane road	Total	60
Nebraska (NDOR)	Rural two-lane road	Cross-over crashes	64
Oregon (Russell and Rys 2005)	Rural two- and four-lane highways	Cross-over crashes	70
Pennsylvania (Golembiewski et al. 2008)	Rural two-lane road	Crossover	48
Washington (Persaud et al. 2004)	Rural two-lane road	Crossover	21

The Delaware Department of Transportation (2005) compared the average yearly accident data prior to and after the installation of CLRSs and identified a benefit-cost ratio of 110 to 1, which indicates that the use of CLRSs is very effective. Carlson and Miles (2003) calculated the benefit-cost ratio of CLRS at approximately 40 to 1 for roadways with high traffic volumes.

2.2 Existing CLRS Designs

Different CLRS types (milled, rolled, formed, and raised) and dimensions exist within the United States. Each type produces different vibration and noise levels. In addition, different installation

methods are used. Milled CLRSs are the prevalent type used among state DOTs. Figure 2-2 presents an example of a CLRS with the terms that describe it and its dimensions. Table 2-2 summarizes CLRS practices in various states, including the types and dimensions of each state's CLRSs, and shows that the most common dimensions of CLRSs used in the United States are (Torbic et al. 2009):

- Length: 12-16 inches;
- Width: 7 inches;
- Depth: 0.5 inches;
- Spacing: 12 inches.

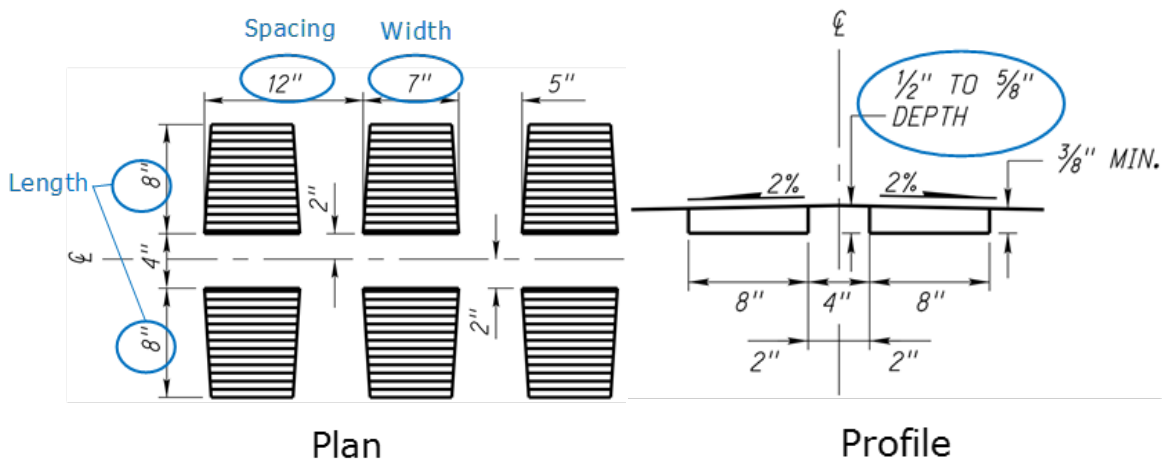

Figure 2-2. Dimensions of CLRSs.

Table 2-2. Summary of CLRS Practices in the United States (Torbic et al. 2009)

State	Pattern characteristics		Dimensions (in.)			
	Roadway type	Type of CLRS	Length	Width	Depth	Spacing
Alaska	Rural two-lane	Milled	12	5-7	0.5	10-12
Colorado	Rural two-lane, Rural multilane undivided	Milled	12	5	0.375	12
Delaware	Rural two-lane, Rural multilane undivided	Milled	16	7	0.5	12
Hawaii	Rural two-lane	Milled	18-24	4	-	24
Iowa	Rural two-lane	Milled	16	7	0.5-0.625	12
Kansas	Rural two-lane	Milled	12	6.5	0.5	12
Kentucky	Rural two-lane	Milled	24	7	0.5-0.625	24
Maryland	Rural two-lane	Milled	18-24	4	0.5	Varies
Massachusetts	Rural two-lane	Milled	16	6	0.5	12
Michigan	Rural two-lane	Milled	16	7	0.375	19
Minnesota	Rural two-lane	Milled	12-16	7	0.5	19
Missouri	Rural two-lane	Milled	12	6.5	0.5	12.5
Nebraska	Rural two-lane	Milled	16	7	0.5-0.625	12
Oregon	Rural two-lane Rural multilane undivided	Milled	16	7	0.5	12
Pennsylvania	Rural two-lane Rural multilane undivided	Milled	16 in.	7 ± 0.5	0.5 ± 0.0625	24 and 48
Texas	Rural two-lane Rural multilane undivided	Milled	16 in.	7	0.5	17
Utah	Rural two-lane Rural multilane undivided	Milled	12 in.	8	0.625-0.75	12
Virginia	Rural two-lane Rural multilane undivided Urban multilane undivided	Milled and Raised	16	7	0.5	12
Washington	Rural two-lane Rural multilane undivided	Milled	16	5	0.375	12
Wyoming	Rural two-lane	Milled	12	7.5	0.5	14.5

2.3 Stimuli Levels for Effective CLRSs

The minimum level of stimuli generated by CLRSs is an important factor to consider when designing CLRSs with optimum noise levels that will alert an inattentive, distracted, drowsy, or fatigued drivers without the noise disturbing nearby residents. Chen (1994) reported that a minimum of 4 dBA was required to alert a driver. Currently, at least 3 to 6 dBA above the ambient sound level is suggested to sufficiently stimulate an inattentive or drowsy driver (Torbic et al. 2009). Among the four dimensions (i.e., length, width, depth, and spacing) of CLRSs, the effect of spacing and depth were investigated. Of the 12 CLRS designs tested, those with 12-inch spacing generated the highest average sound levels followed by the alternating 12- and 24-inch spacing patterns (Russell and Rys 2005). Torbic et al. (2009) stated that CLRS depth should be a minimum of 0.375 inches. Consequently, the CLRS dimensions that create sufficient noise to alert motorists are (Russell and Rys 2005; Torbic et al. 2009):

- Length: 12-24 inches;
- Width: 5-7 inches;
- Depth: 0.375-0.625 inches;
- Spacing: 10-12 inches.

Torbic et al. (2009) provides a noise prediction model to determine the optimum dimensions for CLRSs under a range of operating conditions after conducting field experiments and statistical analysis. The prediction model is as follows:

$$\begin{aligned} SLDiff = & 4.467 + 0.057Speed - 0.275Angle + 0.352Length \\ & + 0.498Width + 3.106Depth - 0.300Spacing \end{aligned} \quad (1)$$

where *SLDiff*: Sound level differential (dBA),

Speed: Travel speed (mph),

Angle: Angle of departure (degree),

Length: CLRS length (inches),

Width: CLRS width (inches),

Depth: CLRS depth (inches), and

Spacing: CLRS spacing (inches).

2.4 CLRS Concerns

Based on a survey by Russell and Rys (2005), 15 DOTs did not believe that CLRSs caused pavement deterioration due to ice or water accumulation in the CLRS grooves. However, several DOT maintenance crews report that heavy traffic increases pavement deterioration when CLRSs are employed and that water and ice accumulation in CLRS grooves cracks the pavement (Torbic et al. 2009). Additionally, 1% of the strips inspected in Virginia were deteriorating. Many studies (Kirk 2008; Knapp and Schmit 2009; Torbic et al. 2009) concluded that the main cause of joint deterioration is not water or ice accumulation, but poor pavement conditions before the installation of CLRSs. Kirk (2008) investigated whether the installation of CLRSs causes the joint deterioration found on two roadways in Kentucky and found that these roads had poor pavement performance even before CLRS installation. Therefore, water and ice accumulation in the CLRS grooves was not an issue. Knapp and Schmit (2009) reported that the joint degradation promoted by CLRSs appears to occur when the pavement condition is not adequate prior to CLRS installation. In fact, seven of nine surveyed states indicated that they were not aware of any winter maintenance problems.

2.5 Studies on CLRSs by State DOTs

The Colorado Department of Transportation evaluated the effectiveness of CLRSs installed in the no-passing zones of a two-lane, undivided mountain highway (Outcalt 2001). Crash data for approximately four years prior to and after CLRS installation show a 22% and 25% reduction in head-on crashes and opposing-direction sideswipe crashes, respectively, even if the average annual daily traffic increased. In Massachusetts, head-on and angle collisions were investigated on three undivided roadways with CLRSs installed (Noyce and Elango 2003). The statistical analysis of the crash data shows no significant reduction in the crashes after CLRS installation. However, no fatal crashes occurred on two of the roadways after the installation of CLRSs, indicating that CLRS may reduce the severity of crashes. The Missouri Department of Transportation installed CLRSs on a two-lane, undivided roadway and monitored the number of total crossover centerline crashes as well as the severity of these crashes (Chandler et al. 2008). A significant reduction in these crashes was reported (60% and 84%, respectively). Finley et al. (2009) evaluated the impact of

CLRS in Texas. Field studies indicate that installing CLRSs on two-lane roadways with lane widths as narrow as 10 ft. did not adversely impact the lateral placement of the vehicle. In fact, drivers positioned the center of their vehicle closer to the center of the lane with the CLRSs and smaller shoulder. CLRSs have the potential to improve safety. The Washington State Department of Transportation (Olson et al. 2011; Olson et al. 2013) evaluated the performance of CLRSs under a variety of traffic volumes, geometric conditions of roadways, lane and shoulder widths, and driver contributing circumstances and found that crash rates seemed to be influenced by traffic volume, and tangent roadways resulted in the greatest crash rate reductions. In addition, reductions in fatal and serious injury crash rates on roads with an 11-ft. lane width were slightly more than those with a 12-ft. lane width. Datta et al. (2015) evaluated the safety performance of CLRSs on two-lane, high-speed highways in Michigan. The crash analysis indicated statistically significant reductions in all target crashes, including head-on, sideswipe, opposite, and run-off-the-road left crashes. The study of crashes and their severity also revealed a reduction in all injury crashes, including fatal crashes. Additionally, the benefit-cost ratio of CLRSs was estimated to be 58:1 to 18:1.

Chapter 3 Design of Modified CLRS

Based on the literature review and discussions with the technical advisory committee (TAC) members, three modified CLRS designs were developed. The configurations and dimensions specified for each modified design are presented in Figure 3-1. Since CLRSs cause drivers to move further away from the centerlines (Torbic 2009), it is important to maintain a minimum travel lane width for drivers' safety. In addition, the dimensions of each modified design were evaluated to determine whether they generated enough noise (i.e., *SLDiff*) to alert motorists (Russell and Rys 2005; Torbic et al. 2009). Table 3-1 shows the *SLDiff* values of each modified design as well as Nebraska's current CLRS design (8-inches in length, 4-inches in width, and 0.5-inches in depth). All the designs satisfied the recommended sound level differential in the range of 10 to 15 dBA (Russell and Rys 2005; Torbic et al. 2009).

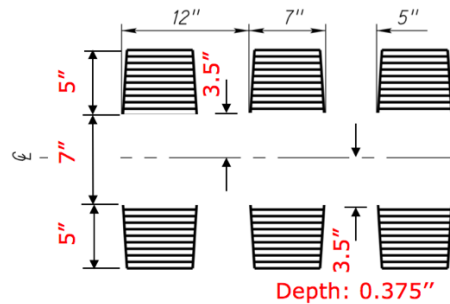

Design #1

(a) Modified Design 1

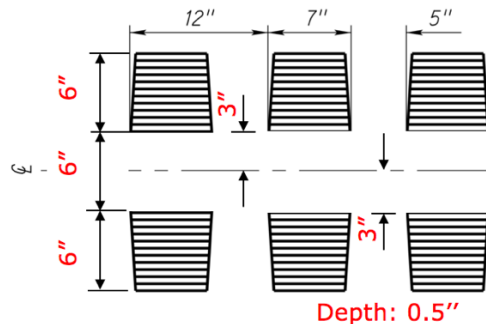

Design #2

(b) Modified Design 2

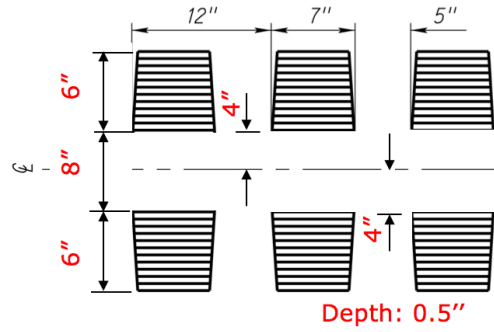

Design #3

(c) Modified Design 3

Figure 3-1. Three modified CLRS designs considered.

Table 3-1. *SLDiff* Values of CLRS Designs (Three Modified and One Current)

	<i>SLDiff</i> (dBA)	Length (in.)	Depth (in.)	Width (in.)	Spacing (in.)	Speed (mph)	Departure angle (degree)
8''-4''-8''	12.2-15.5	16	0.5	7	12	55-75	1-9
5''-7''-5''	10.0-13.0	10	0.375				
6''-6''-6''	10.8-14.1	12	0.5				
6''-8''-6''							

Chapter 4 Pavement Modeling and Simulations

This chapter presents the stress and damage analysis of the current Nebraska CLRS design (i.e., 8-inches in length, 4-inches in width, and 0.5-inches in depth) and the three proposed modified CLRS designs (Table 3-1), which was completed using a finite element modeling approach. Although the modified designs can be directly evaluated using field tests in a follow-up research project, numerical pavement modeling and simulations can be used to assess whether the modified designs will result in less pavement damage than the current design and to calculate this expected reduction in pavement damage. The two most common pavement structures in Nebraska (i.e., a composite pavement structure, which includes a four-inch asphalt overlay on top of a concrete slab, and a concrete pavement structure, which is a concrete slab with joint cut and tie bars embedded) were modeled using the two-dimensional (2-D) finite element method.

4.1 Composite Pavement Modeling and Simulations

Figure 4-1 shows a schematic cross-sectional profile of a composite pavement structure and its finite element mesh details. The schematic includes an asphalt overlay on a Portland cement concrete (PCC) layer. The base and/or subgrade are located below the PCC layer, but they were not included in the finite element model because the stress and damage potential of the surface layer (i.e., 4-in thick asphalt overlay) due to the different CLRS designs is the primary interests of the pavement modeling process. The finite element model is constructed using graded meshes, which can reduce the computational time without affecting the model's accuracy. Graded meshes typically have finer elements close to the high-stress gradient zone, such as the surface layer where the CLRSs are placed in the center of the pavement, and coarser elements for regions of low-stress gradient. A commercial software package, *ABAQUS* was used to conduct 2-D finite element modeling. Infinite elements were used for both sides of the model, and the bottom of the mesh was fixed in the vertical direction.

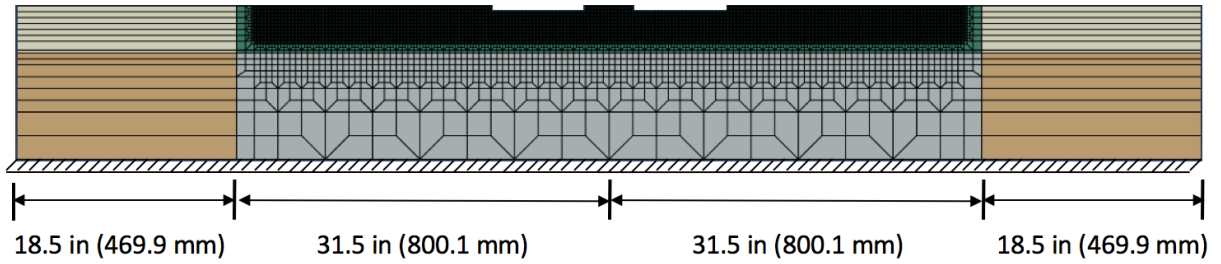

Figure 4-1. A schematic cross-sectional profile of a composite pavement structure and its mesh.

In this study, a viscoelastic model was employed to simulate the behavior of the asphalt layer when the pavement is subjected to tire loading. To avoid unnecessary complexities and simplify the simulation, the inertial effects of the dynamic traffic loads, body forces, and large deformations were ignored. Linear elastic behavior was assumed for the modeling of the underlying PCC layer. Table 4-1 presents the material properties of the individual layers for the composite pavement. Poisson’s ratios of 0.35 and 0.20 were assumed for asphaltic material and PCC, respectively. It was also assumed that the interface between the asphalt overlay and the PCC layer was fully bonded.

Table 4-1. Material Properties of Each Layer

Asphalt Overlay Properties (Linear Viscoelastic)			
n	$\lambda_n (\text{s}^{-1})$	$D_n (\text{MPa}^{-1})$	ν
0	-	6.69×10^{-5}	0.35
1	1.41×10^4	2.85×10^{-5}	
2	1.84×10^3	3.24×10^{-5}	
3	2.40×10^2	6.31×10^{-5}	
4	3.13×10^1	1.30×10^{-4}	
5	4.08×10^0	2.52×10^{-4}	
6	5.32×10^{-1}	5.21×10^{-4}	
7	6.94×10^{-2}	1.76×10^{-3}	
8	9.05×10^{-3}	3.30×10^{-3}	
9	1.18×10^{-3}	8.11×10^{-3}	
Portland Cement Concrete Layer Properties (Linear Elastic)			
	$E (\text{MPa})$		ν
	2.66×10^4		0.20

Figure 4-2 shows four different finite element meshes. These meshes are identical with the exception of the CLRS designs placed on top of the asphalt overlay, which enables stress and pavement response comparisons based solely on the different CLRS designs. To present the region details for each CLRS case, zoomed-in meshes are shown in Figure 4-3. The mesh size and structure are identical among the four cases with the exception of the geometry (size, interval, and depth) of the CLRSs.

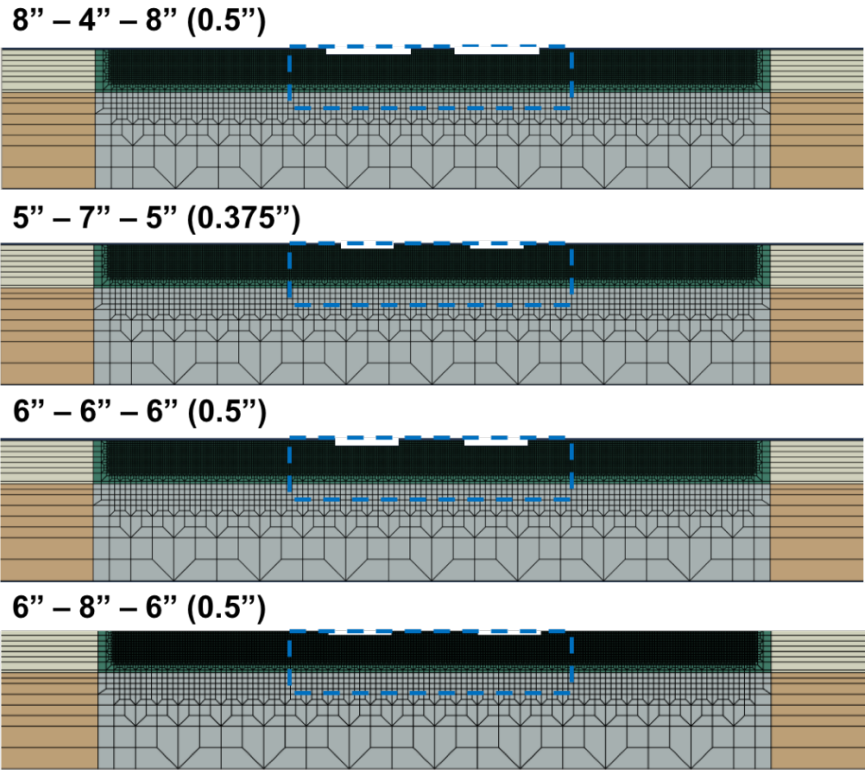

Figure 4-2. Four finite element meshes of a composite pavement with different CLRS designs.

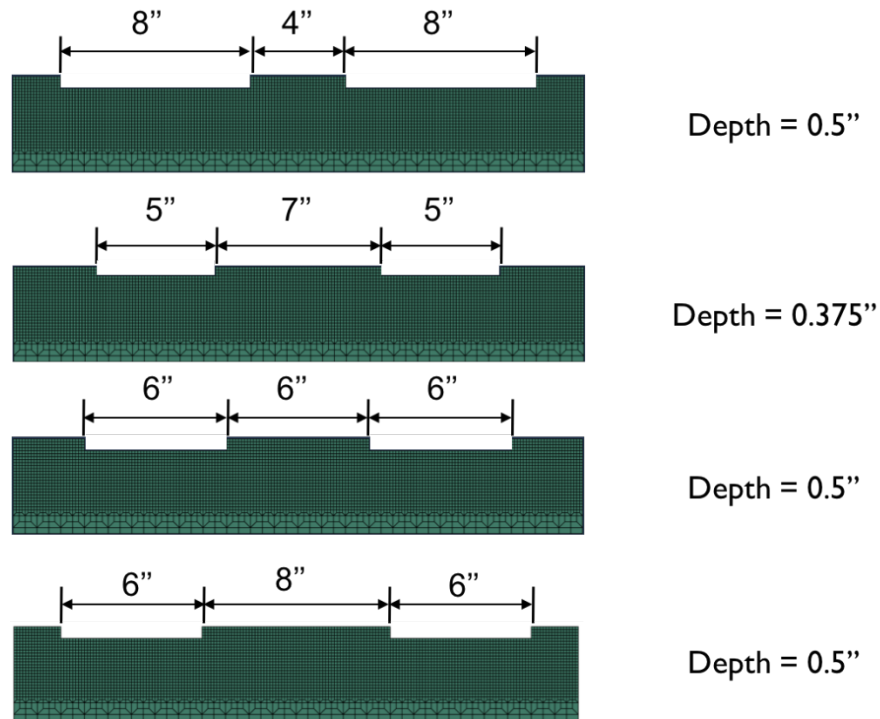

Figure 4-3. Zoomed-in finite element meshes of a composite pavement with different CLRSSs.

Figure 4-4 illustrates the loading configurations. Traditionally, either the circular or rectangular distribution of contact pressure has been applied to model tire loading for simplicity; however, neither represents real tire footprints. Since this study attempts to model pavement responses and damage potential due to different CLRSS designs, actual tire footprints with varying widths and pressure distributions along the ribs were employed. The tire loading was applied to the pavement surface in two different scenarios: (1) the placement of the tire in the middle of the two CLRSSs and (2) the placement of the tire's center rib on one edge of the right CLRSS. The two loading scenarios were considered as representative cases to investigate potential pavement damage due to the existence of the two CLRSSs.

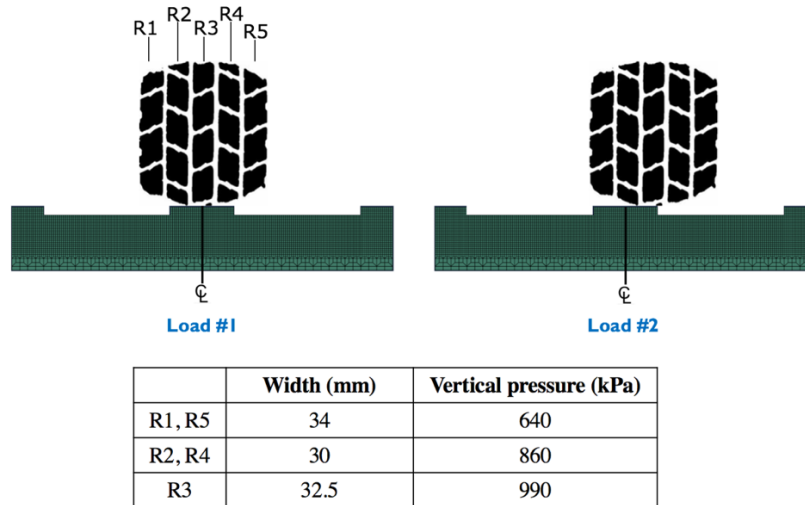

Figure 4-4. Two different tire loading scenarios considered for composite pavement modeling.

The results of the finite element model simulation in a form of von Mises stress contour for the first loading scenario (i.e., the placement of the tire in the middle of the two CLRSs) are presented in Figure 4-5. For comparison purposes, a case without a CLRS was also simulated, and its results are included in Figure 4-5. As indicated by the contour legend, higher stress is represented in red and lower stress is in blue on the contour plot. Contact between the tire's rib and pavement surface caused different stress distribution based on the different CLRS geometries.

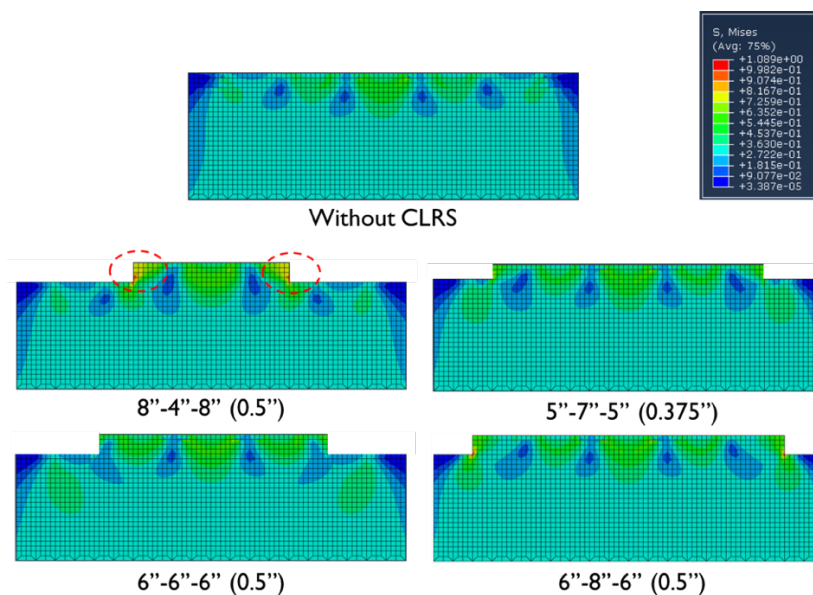

Figure 4-5. Stress contour plots of composite pavement without and with CLRSs: 1st loading.

In an attempt to visualize and quantify the maximum stress experienced due to individual CLRS designs (i.e., one current and three modified), zoomed-in views of the CLRS edge/corner were captured and compared in Figure 4-6. As expected, the highest stress levels were typically observed at the corner of the CLRS, and the current design produces higher stress than the modified designs. Figure 4-6 also presents stress ratio percentages that represent differences in the maximum stress of the reference case (i.e., current CLRS design) and three modified design cases. When the tire load was placed in the middle of the two CLRSs, a modified design (6"-6"-6" with 0.5" depth) experienced the lowest stress (56% of the reference case); this stress is somewhat similar to a second modified CLRS design (5"-7"-5" with 0.375" depth) and much lower than the third modified CLRS design (6"-8"-6" with 0.5" depth).

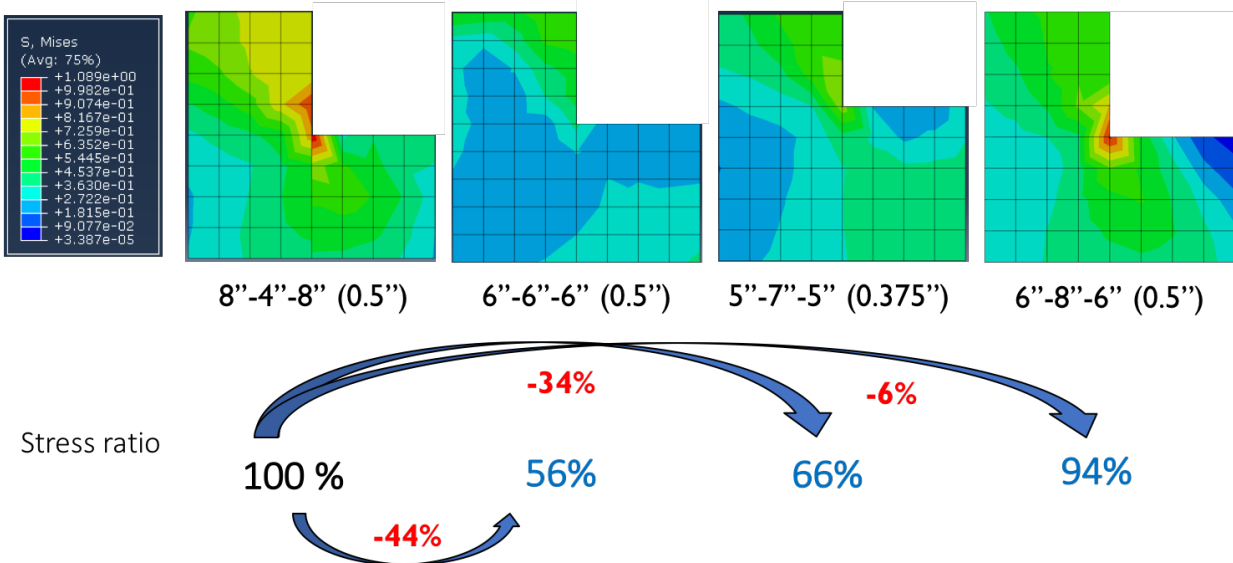

Figure 4-6. Zoomed-in views of CLRS edges-corners of composite pavement: 1st loading.

Figure 4-7 shows the results of the finite element model simulation in a form of the von Mises stress contour for the second loading scenario (i.e., placement of the tire center rib on one edge of the right CLRS). The case without a CLRS was also included and its results are shown in Figure 4-7 for comparison. Higher stress is represented in red and lower stress is in blue on the contour plot. As shown in the figure, the pavements with CLRSs experience higher stress levels than the pavement without CLRSs. In addition, different CLRS designs induced different stress distributions, and the stress distribution shown in the figure is quite different from the stress

distribution from the first loading scenario due to the non-symmetric tire loading on the pavement surface.

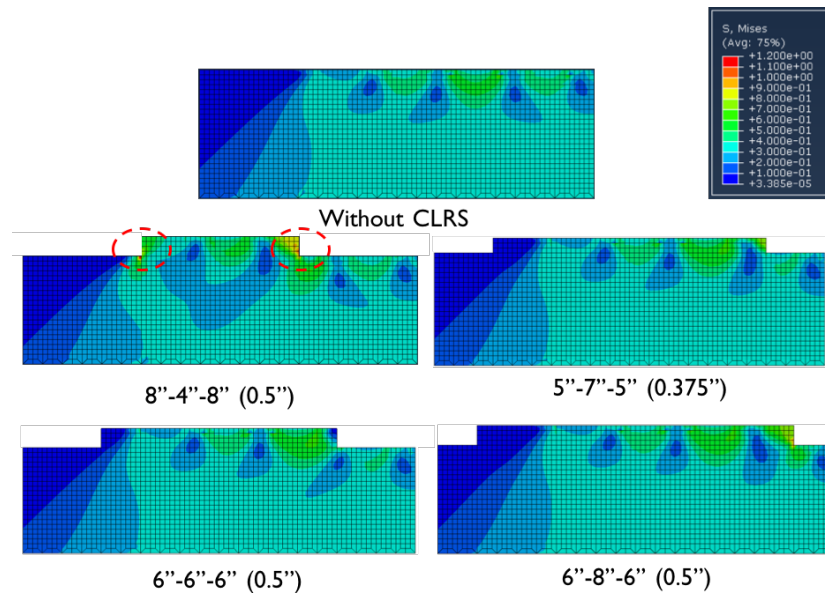

Figure 4-7. Stress contour plots of composite pavement without and with CLRSs: 2nd loading.

To visualize and quantify the maximum stress experienced by individual CLRS designs, zoomed-in views of the CLRS edge/corner were captured and compared in Figure 4-8. As expected, the highest stress is typically observed at the right corner of the CLRS, and the current CLRS design produces higher stress than the modified designs. Figure 4-8 also presents stress ratio percentages that represent the differences in maximum stress between the reference case (i.e., the current CLRS design) and the modified design cases. With the non-symmetric tire loading between the two CLRSs, one modified design (6''-6''-6'' with 0.5'' depth) had the lowest stress (50% of the reference case), which is significantly lower than the other two modified designs: 5''-7''-5'' with 0.375'' depth (73% of the reference case) and 6''-8''-6'' with 0.5'' depth (91% of the reference case).

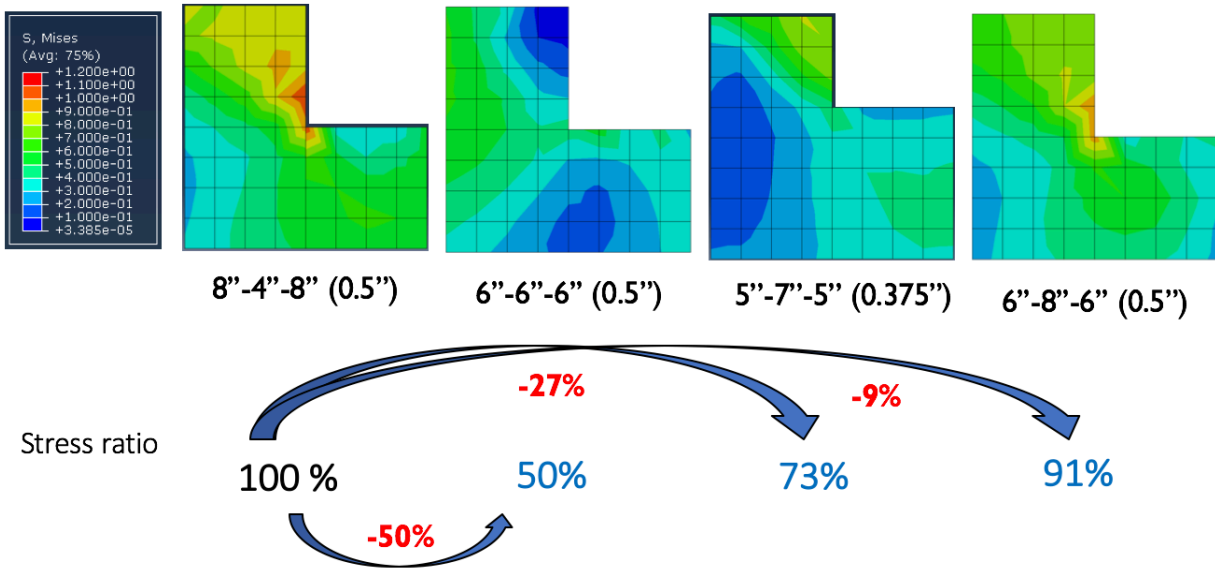
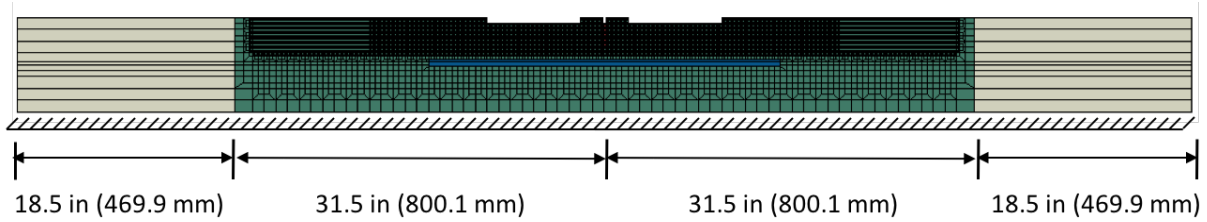

Figure 4-8. Zoomed-in views of CLRS edges-corners of composite pavement: 2nd loading.

4.2 Concrete Pavement Modeling and Simulations

Figure 4-9 shows a schematic cross-sectional profile of a concrete pavement structure and its finite element mesh details. It includes an 8-inch Portland cement concrete slab with an embedded tie bar and a construction joint in the middle of the slab. Joint sealant was inserted in the construction joint. The base and/or subgrade layers are placed below the PCC slab in reality, but they were not included in the finite element model because the stress and damage potential of the surface layer (i.e., 8-in thick PCC slab) due to the different CLRS designs is the primary interests of this pavement model. The finite element model is also constructed with graded meshes, which can reduce the computation time without affecting the model's accuracy. Finer elements were applied above the tie bar, which enabled the capture of any high-stress gradient on the slab surface where the CLRSs were placed in the middle of the pavement. A commercial software package, *ABAQUS* was used to conduct 2-D finite element modeling. Infinite elements were used for both sides of the model, and the bottom of the model was fixed in the vertical direction.



(a) A schematic cross-sectional profile of a concrete pavement structure and its mesh

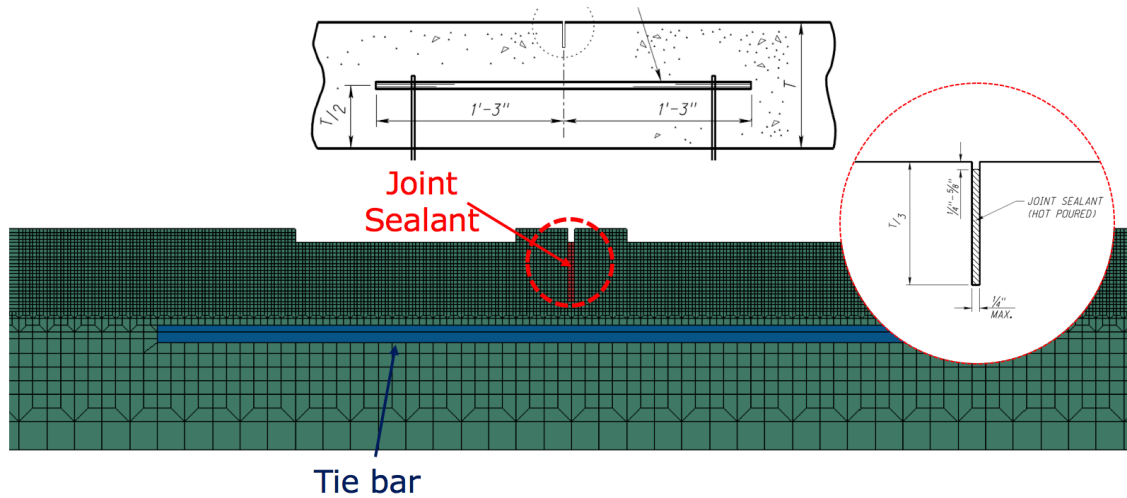

(b) A zoomed-in view in the middle of the PCC slab

Figure 4-9. Finite element model of a concrete pavement in this study.

In the model, the PCC layer was considered elastic material, and the tie bar (in steel) was assumed to be an elastic material. To avoid unnecessary complexities and simplify the simulation, the inertial effects of the dynamic traffic loads, body forces, and large deformations were ignored. The elastic behavior of the PCC layer and the tie bar is reasonable. Table 4-2 presents the material properties (modulus of elasticity and Poisson's ratio) of the PCC layer and the tie bar. The interface between the concrete and tie bar was assumed to be fully bonded.

Table 4-2. Material Properties of Concrete Pavement

Material	E (MPa)	ν
PCC Slab (Linear Elastic)	2.66×10^4	0.20
Tie Bar (Linear Elastic)	2.0×10^5	0.30
Joint Sealant (Linear Elastic)	1.0	0.40

Figure 4-10 shows four different finite element meshes. These meshes are identical except for the CLRS designs in the PCC layer, which enables a comparison of the stress and pavement responses that result solely from the different CLRS designs. The mesh size and mesh structure were identical among the four cases except for the geometry (size, interval, and depth) of the CLRS.

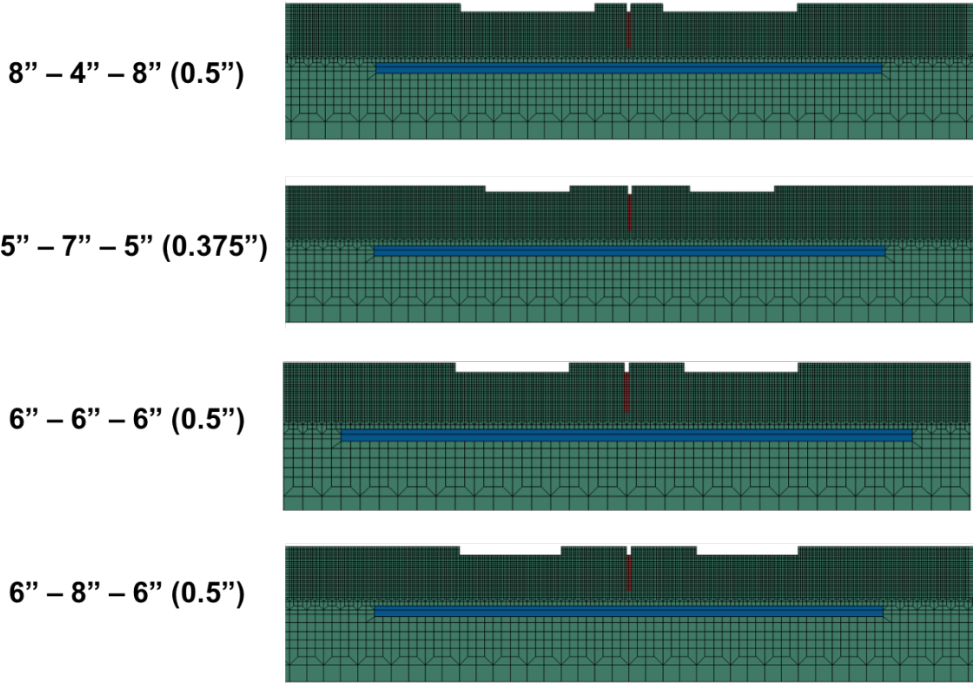

Figure 4-10. Zoomed-in finite element meshes of a concrete pavement with different CLRSs.

Figure 4-11 illustrates the loading configurations. Tire loading was applied to the pavement surface in two different scenarios: (1) the placement of the tire in the middle of the two CLRSs and (2) the placement of the tire's center rib on one edge of the right CLRS. The two loading scenarios were considered to be representative cases to investigate potential pavement damage due to the existence of the two CLRSs.

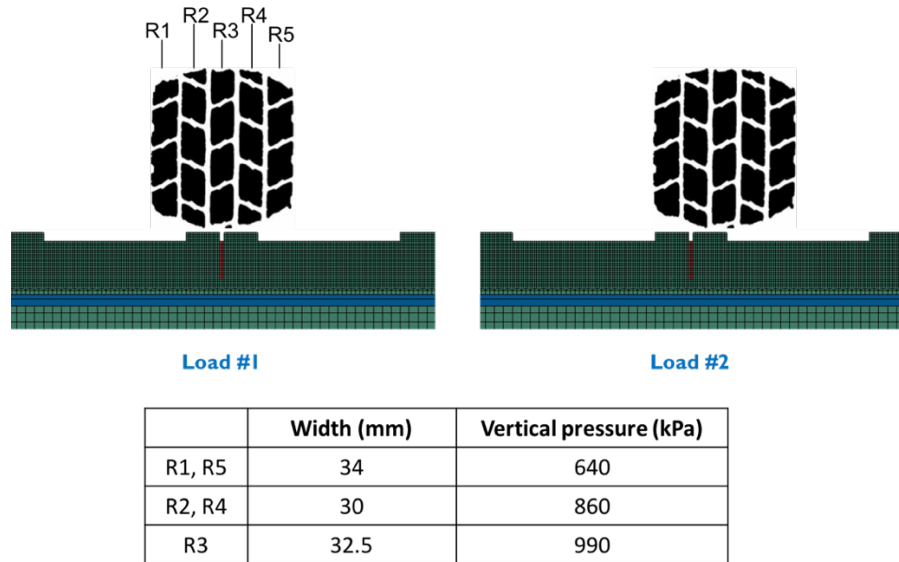

Figure 4-11. Two different tire loading scenarios considered for concrete pavement modeling.

Figure 4-12 presents the results of the finite element model simulation in the form of the von Mises stress contour from the first loading scenario (i.e., the placement of the tire in the middle of the two CLRSs). For comparison purposes, a case without a CLRS was also simulated and its results were included in Figure 4-12. As indicated by the contour legend, higher stress is represented in red and lower stress is in blue on the contour images. Clearly, high stress was found around the joint in all the cases with the same amount, and different stress distributions were induced by different CLRS geometries. Therefore, the joints of the concrete pavement were subjected to the highest potential damage (such as cracking) regardless of the existence of CLRSs. While the CLRSs may induce additional or integrated damage in the pavement with the joint, the level of damage certainly depends on the design of the CLRS, as observed in the figure.

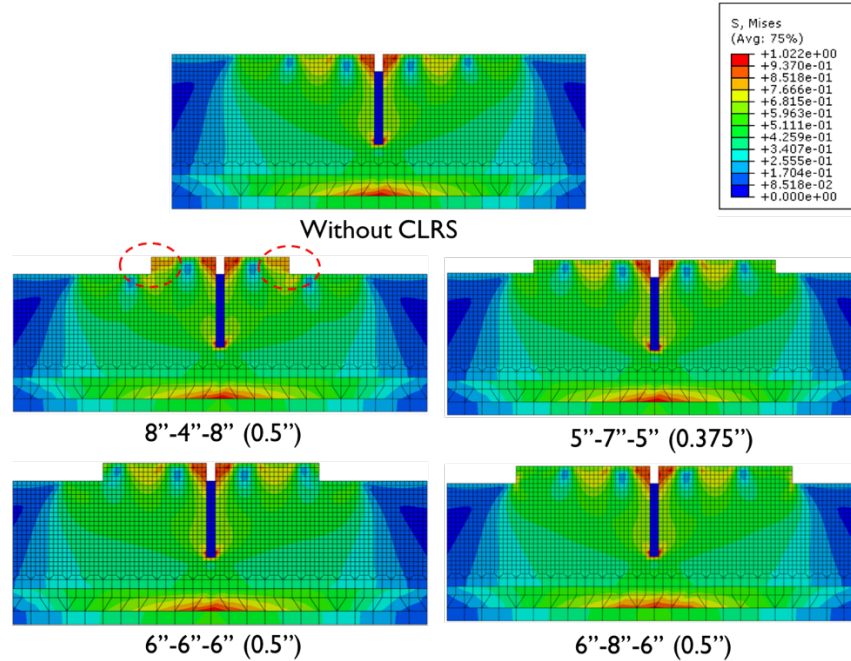

Figure 4-12. Stress contour plots of concrete pavement without and with CLRSs: 1st loading.

To visualize and quantify the stress and potential damage induced by the different CLRS designs (i.e., one current and three modified), zoomed-in views of the CLRSs' edges/corners were captured and compared in Figure 4-13. The higher stress typically occurred at the edge or corner of the CLRS, and the current CLRS design produced higher stress than the modified designs. Figure 4-13 also presents stress ratio percentages to represent the difference in maximum stress between the reference case (i.e., current CLRS design, 8"-4"-8" with 0.5" depth) and the modified design cases. When the tire load was placed in the middle of the two CLRSs, one modified design (6"-6"-6" with 0.5" depth) produced the lowest stress (72% of the reference case); this was somewhat similar to another modified design (5"-7"-5" with 0.375" depth) and lower than the 3rd modified design (6"-8"-6" with 0.5" depth).

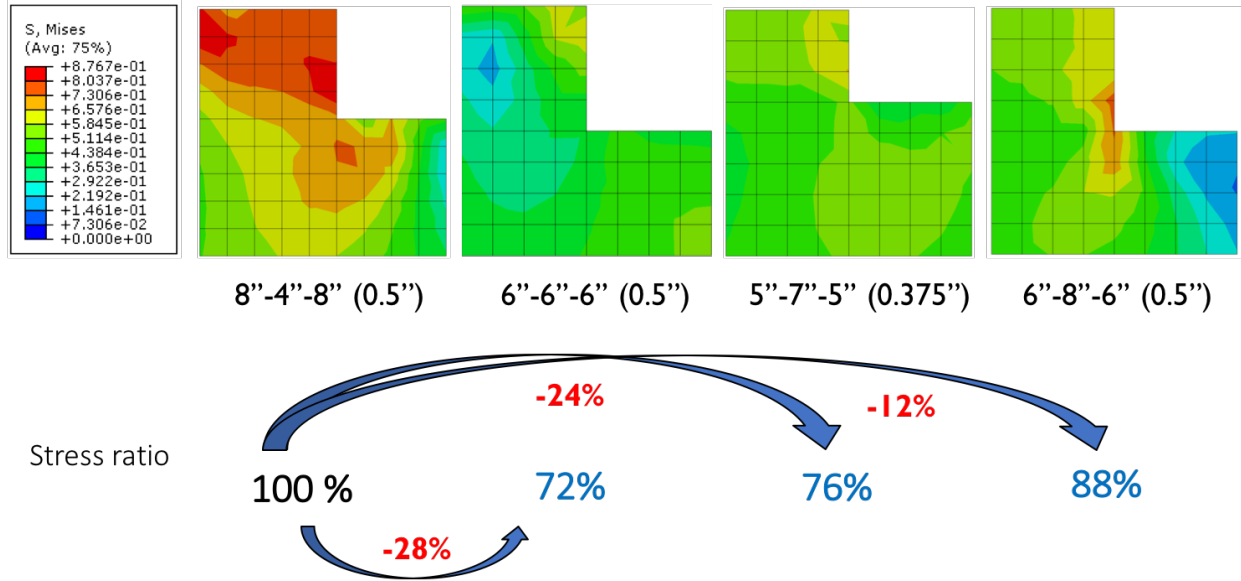

Figure 4-13. Zoomed-in views of CLRS edges-corners of concrete pavement: 1st loading.

Figure 4-14 shows the results from the finite element model simulations for the concrete pavements from the second loading scenario (i.e., the placement of the tire's center rib on one edge of the right CLRS). A case without CLRS was also included and its results are shown in Figure 4-14 for comparison. Higher stress is represented in red and lower stress is in blue on the contour plot. The same amount of highest stress was found at the end of the joint in all the cases, but different stress distributions were induced by different CLRS geometries. In general, the pavements with CLRSs experience higher stress levels than the pavement without a CLRS. The stress distribution shown in the figure is quite different from the stress distribution in the first loading scenario due to the non-symmetric tire loading placed on the pavement surface. Different CLRS designs induced different stress distributions.

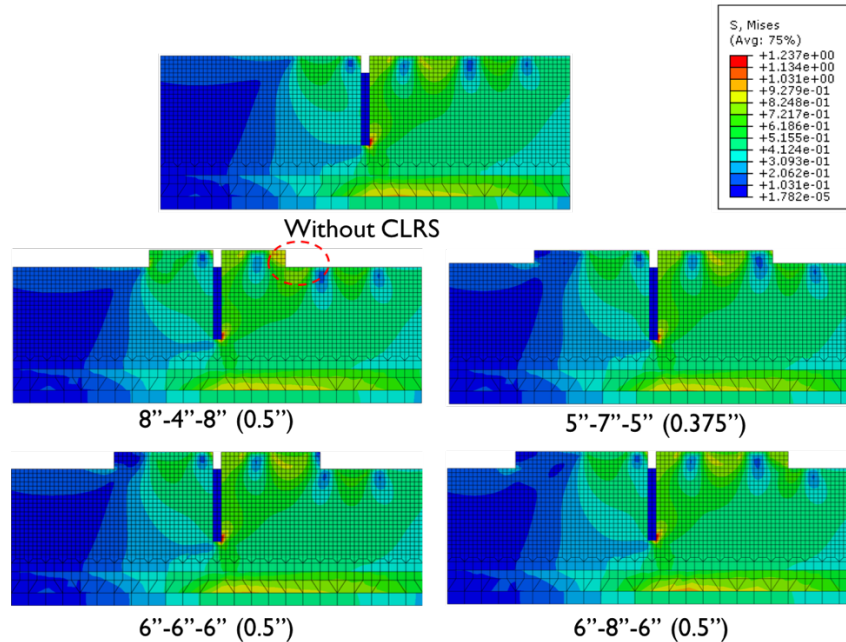

Figure 4-14. Stress contour plots of concrete pavement without and with CLRSs: 2nd loading.

To visualize and quantify the dominant stress experienced by individual CLRS designs, zoomed-in views of CLRS edges/corners were captured and compared in Figure 4-15. As expected, the highest stress were observed at the right corner/edge of the CLRS, and the current CLRS design produced higher stress than the modified designs. Figure 4-15 also presents stress ratio percentages that represent the difference in maximum stress between the reference case (i.e., current CLRS design) and the modified design cases. With non-symmetric tire loading between the two CLRSs, one modified design (6”-6”-6” with 0.5” depth) had the lowest stress (81% of the reference case), lower than the other two modified designs.

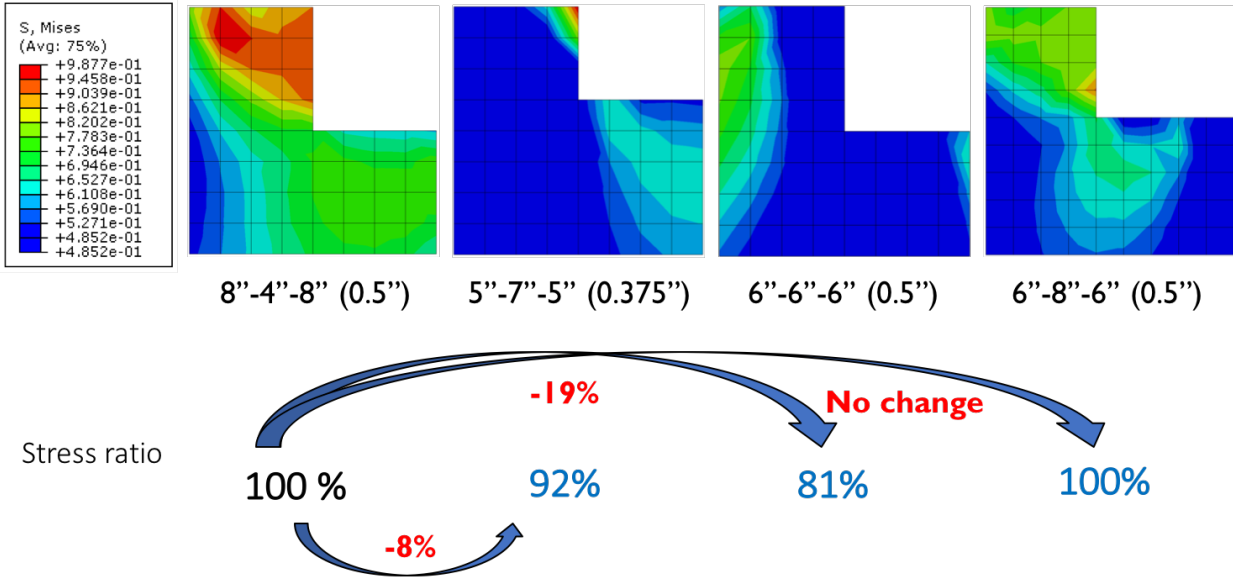

Figure 4-15. Zoomed-in views of CLRS edges-corners of concrete pavement: 2nd loading.

Chapter 5 Summary and Conclusions

In this research project, new (or modified) CLRS designs were sought to reduce pavement damage, while satisfying the primary purpose of CLRSs, to reduce cross-over crashes, such as head-on, opposite-direction sideswipe, and front-to-side crashes. A literature review of national/regional studies, including investigations of the CLRS design practices in different states, was conducted. Based on the literature review results and discussions with the project TAC members, three modified CLRS designs were proposed. Then, the current (8''-4''-8'' with 0.5'' depth) and modified designs (6''-6''-6'' with 0.5'' depth, 5''-7''-5'' with 0.375'' depth, and 6''-8''-6'' with 0.5'' depth) were evaluated using finite element pavement modeling and simulations to assess the stress and damage potential of pavements associated with the different CLRS designs (geometries). Two primary types of pavements in Nebraska (i.e., (1) composite pavements that include an asphalt overlay placed on cement concrete slab and (2) concrete pavements) were considered, and the cases' simulation results were compared to propose the one to two best alternative CLRS designs that may reduce pavement damage without compromising drivers' safety. Based on the results, the following conclusions can be drawn:

- Pavements with CLRSs showed higher stress than pavements without CLRSs. In addition, each CLRS design induced different stress distributions (and damage potential) due to different tire-pavement contact;
- The highest stress typically occurred at the corner/edge of the CLRS, and the current CLRS design (i.e., 8''-4''-8'' with 0.5'' depth) produced higher stress than the modified designs in both types of pavements (i.e., composite pavement and concrete pavement);
- A comparison of the three modified CLRS designs in this study showed that the modified design (6''-6''-6'' with 0.5'' depth) generally yielded the lowest stress;
- This research provides preliminary insights into how a modified CLRS design can reduce the pavement damage that results from the current CLRS design. However, the findings should be validated through field testing in a follow-up effort.

References

- AECOM (2008). "Safety enhancement evaluation of ground-in centerline rumble strips." Report to Arizona Department of Transportation, Phoenix, AZ.
- Briese, M. (2006). "Safety effects of centerline rumble strips in Minnesota."
- Carlson, P. J., and Miles, J. D. (2003). "Effectiveness of rumble strips on Texas highways: First year report."
- Chandler, B., Schaefer, J., and Stumpe, D. (2008). "MO 21 Rumble Strip Study." Missouri Department of Transportation, Jefferson City, Missouri.
- Chen, C. S. (1994). "A study of effectiveness of various shoulder rumble strips on highway safety."
- Datta, T. K., Savolainen, P. T., Gates, T. J., Kay, J. J., Nicita, N. B., Parajuli, S., and Finkelman, J. (2015). "Evaluation of Non-Freeway Rumble Strips-Phase II." Michigan Department of Transportation, Lansing, MI.
- Delaware Department of Transportation (2005). "CRS: The Delaware Experience." <<http://www.deldot.net/static/projects/rumblestrip/handout.pdf>>. (November, 2005).
- Finley, M. D., Funkhouser, D. S., and Brewer, M. A. (2009). "Studies to determine the operational effects of shoulder and centerline rumble strips on two-lane undivided roadways." Texas Transportation Institute, Texas A & M University System.
- Fitzpatrick, K. (2000). Accident mitigation guide for congested rural two-lane highways, Transportation Research Board.
- Golembiewski, G., Haas, R., Katz, B., and Bryer, T. (2008). "Evaluation of the effectiveness of PennDOT's low cost safety improvement program (LCSIP)." Science Applications International Corporation.
- Harkey, D. L., Program, N. C. H. R., Highway, A. A. o. S., and Officials, T. (2008). Accident modification factors for traffic engineering and ITS improvements, Transportation Research Board.
- Karkle, D. E. (2011). "Effects of centerline rumble strips on safety, exterior noise, and operational use of the travel lane." Kansas State University.
- Karkle, D. E., Rys, M. J., and Russell, E. R. "Evaluation of centerline rumble strips for prevention of highway crossover accidents in Kansas." Proc., Proceedings of the 2009 Mid-Continent Transportation Research Symposium.

- Kirk, A. (2008). "Evaluation of the Effectiveness of Pavement Rumble Strips."
- Knapp, K. K., and Schmit, M. (2009). "Assessment of Centerline Rumble Strips in Minnesota: Executive Summary and Project Task Summary Attachments." S. a. L. P. P. Center for Excellence in Rural Safety, Hubert H. Humphrey Institute of Public Affairs, ed., University of Minnesota, Minneapolis, MN.
- Manchas, B., Glad, R. W., Sujka, M., and Olson, D. (2011). "Performance analysis of centerline rumble strips in Washington State."
- Missouri Department of Transportation "unpublished results provided to the research team."
- Nebraska Department of Roads "unpublished results provided to the research team."
- Noyce, D. A., and Elango, V. (2003). "Safety evaluation of centerline Rumble Strips."
- Olson, D., Manchas, B., Glad, R. W., and Sujka, M. (2011). "Performance analysis of centerline rumble strips in Washington State."
- Olson, D., Sujka, M., and Manchas, B. (2013). "Performance Analysis of Centerline and Shoulder Rumble Strips Installed in Combination in Washington State."
- Outcalt, W. (2001). "Centerline Rumble Strips."
- Persaud, B. N., Retting, R. A., and Lyon, C. A. (2004). "Crash reduction following installation of centerline rumble strips on rural two-lane roads." *Accident Analysis & Prevention*, 36(6), 1073-1079.
- Russell, E. R., and Rys, M. J. (2005). "NCHRP Synthesis 339: Centerline Rumble Strips." Transportation Research Board, Washington, DC.
- Torbic, D. J., Hutton, J. M., Bokenkroger, C. D., Bauer, K. M., Harwood, D. W., Gilmore, D. K., Dunn, J. M., Ronchetto, J. J., Donnell, E. T., III, H. J. S., Garvey, P., Persaud, B., and Lyon, C. (2009). Guidance for the design and application of shoulder and centerline rumble strips, Transportation Research Board.